



ارائه به روزترین منابع، کتابها و جزوات مهندسی عمران  
به زبان فارسی و انگلیسی به صورت کاملاً رایگان

[www.TheSetosa.com](http://www.TheSetosa.com)



Risk Management Series

# Design Guide

for Improving School Safety in Earthquakes, Floods,  
and High Winds

FEMA P-424 / December 2010



FEMA



---

Risk Management Series Publication

# Design Guide

for Improving School Safety in Earthquakes, Floods,  
and High Winds

FEMA P-424 / December 2010



**FEMA**



---

**T**he views, opinions, findings, conclusions, or recommendations expressed in this publication are those of the authors and do not necessarily reflect the official policy or position of the Department of Homeland Security (DHS), Federal Emergency Management Agency (FEMA), or other federal agencies. The publication of these views by FEMA does not confer any individual rights or cause of action against the United States. Additionally, neither FEMA or any of its employees makes any warrantee, expressed or implied, or assumes any legal liability or responsibility for the accuracy, completeness, or usefulness of any information, product, or process included in this publication. Users of information from this publication assume all liability arising from such use.

Any appearances of hyperlinks do not constitute endorsement by FEMA of the website or the information, products, or services contained therein. For links outside FEMA, FEMA does not exercise any editorial control over the information you may find at these locations. Users must adhere to any intellectual property rights contained in this publication or in material in linked websites.

# Design Guide

## for Improving School Safety in Earthquakes, Floods, and High Winds

# Foreword and Acknowledgments

## Background

Our society places great importance on the education system and its schools, and has a tremendous investment in current and future schools. Nearly 50 million students were expected to attend approximately 99,000 public elementary and secondary schools in the fall of 2009, with an additional 5.8 million expected to attend private schools.<sup>1</sup> The sizes of these school facilities range from one-room rural schoolhouses to citywide and mega schools that house 5,000 or more students. The school is both a place of learning and an important community resource and center.

This publication is concerned with the protection of schools and their occupants against natural hazards. Architects and engineers deal with natural hazards in building design and construction and building codes have provisions for protection against natural hazards.

This manual addresses two core concepts: multi-hazard design and performance-based design. Neither is revolutionary, but both represent an evolution in design thinking that is in tune with the increasing complexity of today's buildings and that takes advantage of developments and innovations in building technology:



<sup>1</sup> U.S. Department of Education, National Center for Education Statistics, Fast Facts, Back to School Stats, <http://nces.ed.gov/fastfacts/display.asp?id=372>, accessed April 19, 2010.

- **Multi-hazard design** recognizes the fundamental characteristics of hazards and how they interact, so that design for protection becomes integrated with all the other design demands.
- **Performance-based design** suggests conducting a systematic investigation to ensure that the specific concerns of building owners and occupants are addressed, rather than relying on only the minimum requirements of the building code for protection against hazards. Building codes focus on providing life safety, while property protection is secondary. Performance-based design provides additional levels of protection that cover property damage and functional interruption within a financially-feasible context.

This publication stresses that the identification of hazards and their frequency and careful consideration of design to resist these hazards must be integrated with all other design issues, and be included from the inception of the site selection and building design process. Although the basic issues to be considered in planning a school construction program are more or less common to all school districts, the specific processes differ greatly because each school district has its own approach. Districts vary in size, from a rural district responsible for only a few schools, to a city district or statewide system overseeing a complex program of all school types and sizes. Any of these districts may be responsible for new design and construction, renovations, and additions. While one district may have a long-term program of school construction and be familiar with programming, financing, hiring designers, bidding procedures, contract administration, and commissioning a new building, another district may not have constructed a new school for decades, and have no staff members familiar with the process.

## Scope

**T**his publication is intended to provide design guidance for the protection of school buildings and their occupants against natural hazards. It focuses on the design of elementary and secondary schools (K–12), as well as repair, renovation, and additions to existing schools. It is one of a series of publications in which multi-hazard and performance-based design are addressed (FEMA 577, *Design Guide for Improving Hospital Safety in Earthquakes, Floods, and High Winds*, and FEMA 543, *Design Guide for Improving Critical Facility Safety from Flooding and High Winds*).

This publication considers the safety of school buildings to occupants, and the economic losses and social disruption caused by building damage and destruction. The volume covers three natural hazards that have the potential to result in unacceptable risk and loss: earthquakes, floods,

and high winds. A companion volume, FEMA 428, *Primer to Design Safe School Projects in Case of Terrorist Attacks*, covers the manmade hazards of physical, chemical, biological, and radiological attacks.

This publication is intended to assist design professionals and school officials involved in the technical and financial decisions related to school construction, repair, and renovations.

## Organization and Content of the Manual

**C**hapters 1–3 present issues and background information that are common to all hazards. Chapters 4–6 cover the development of specific risk management measures for each of the three natural hazards addressed.

**Chapter 1** opens with a brief outline of the past, present, and future of school design. Past school design is important because many of these older, and even historic, schools are still in use and may be exposed to the effects of earthquakes, floods, and high winds.

**Chapter 2** introduces the concept of performance-based design, an approach to design that is driven by the desired performance of a new or retrofitted facility.

**Chapter 3** introduces the concept of multi-hazard design and presents a general description and comparison of the hazards, including charts that show how the design to resist one hazard may interact with the design for other hazards.

**Chapters 4, 5, and 6** outline how to address risk management concerns for protection of schools against earthquakes, floods, and high winds, respectively. Information is presented on the nature of each hazard and its effect on vulnerability, as well as and the consequences of building exposure. Procedures for risk assessment are followed by descriptions of current methods of reducing the effects of each hazard. These methods vary, depending on the hazard under consideration.

**Appendix A** contains a list of acronyms that appear in this manual.

This publication provides recommendations to create safe schools, but is necessarily limited. Readers should not expect to use the information directly to develop plans and

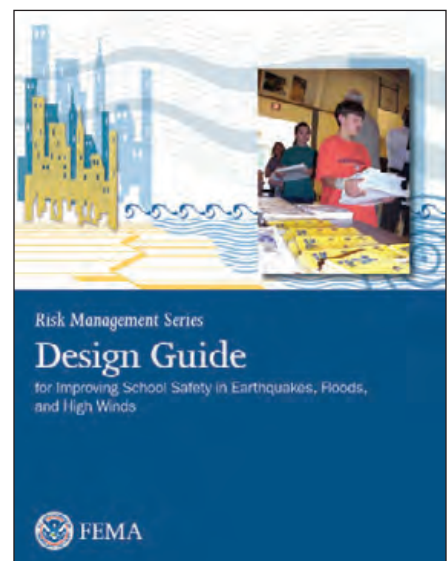

specifications. Rather, the information is intended to help designers and facility decision-makers, who may be unfamiliar with the concepts involved, to understand fundamental approaches to risk mitigation planning and design. With this understanding, they can then approach the implementation phase of detailed planning, which involves consultants, procurement personnel, and project administration.

## **Acknowledgments**

### **Principal Authors:**

Christopher Arnold, Building Systems Development, Inc.

Jack Lyons, School Facilities Consultant

James Munger, James G. Munger and Associates

Rebecca C. Quinn, RCQuinn Consulting, Inc.

Thomas L. Smith, TlSmith Consulting, Inc.

### ***2010 Update:***

Philip Line, URS Corporation

Rebecca C. Quinn, RCQuinn Consulting, Inc.

Thomas L. Smith, TlSmith Consulting, Inc.

### **FEMA Contributors:**

Milagros Kennett, DHS, S&T

John Plisich, FEMA, Region IV

Mike Robinson, FEMA HQ

### ***2010 Update:***

Paul Tertell, PE, FEMA HQ

### **Reviewers and Contributors:**

Joe Agron, American School and University

Deb Daly, Greenhorne & O'Mara, Inc.

Connie Deshpande, U.S. Department of Education

Randy Haslam, Jordan, Utah, School District

Danny Kilcollins, Florida Department of Community Affairs  
Fred Kringold, World Institute for Disaster Risk Management  
Tom Kube, Council of Educational Facility Planners International  
Eric Letvin, URS Corporation, Consultant and Project Manager  
Julie Liptak, Greenhorne & O'Mara, Inc.  
Bill Modzeleski, Department of Education  
Jack Paddon, Williams and Paddon Architects and Planners  
Bob Pendley, Greenhorne & O'Mara, Inc.  
Bebe Pinter, Harris County Department of Education  
Wanda Rizer, Consultant  
John Sullivan, Portland Cement Association  
Jon Traw, Traw Associates  
French Wetmore, French and Associates

***2010 Update:***  
Eric Letvin, URS Corporation, Consultant and Project Manager  
Ivy Porportage, URS Corporation  
Wanda Rizer, Consultant  
Scott Tezak, URS Corporation, Consultant and Project Manager

This publication will be revised periodically and FEMA welcomes comments and feedback to improve future editions.

Please send comments and feedback via e-mail to [riskmanagementseriespubs@dhs.gov](mailto:riskmanagementseriespubs@dhs.gov).



# Design Guide

for Improving School Safety  
in Earthquakes, Floods, and High Winds

## Table of Contents

<b>Foreword and Acknowledgments</b> .....	i
Background .....	i
Scope .....	ii
Organization and Content of the Manual.....	iii
Acknowledgments .....	iv
Principal Authors .....	iv
Contributors .....	iv
<b>1 An Overview of the School Design and Construction Process</b> .....	1-1
1.1 Introduction .....	1-1
1.2 School Construction: The National Picture .....	1-2
1.3 Past School Design.....	1-2
1.4 Present School Design.....	1-8
1.5 Future School Design .....	1-9
1.6 The Design and Construction Process.....	1-11
1.7 References.....	1-14
<b>2 Performance-Based Design</b> .....	2-1
2.1 Background.....	2-1
2.2 Prescriptive vs. Performance-Based Design .....	2-3



2.3	The Performance-Based Design Process .....	2-4
2.4	Acceptable Risk and Performance Levels.....	2-5
2.5	Considerations For Achieving Continuous Operation Performance Level .....	2-8
2.6	Performance-Based Flood Design .....	2-10
2.7	Performance-Based High-Wind Design .....	2-11
2.8	Performance-Based Seismic Design .....	2-12
2.9	References.....	2-14
<b>3</b>	<b>Multihazard Design</b> .....	<b>3-1</b>
3.1	Introduction .....	3-1
3.2	The Hazards Compared .....	3-1
3.2.1	Location: Where do Hazards Occur? .....	3-2
3.2.2	Warning: How Much Warning is There? .....	3-4
3.2.3	Frequency: How Likely are They to Occur?.....	3-5
3.3	A Comparison of Potential Losses .....	3-6
3.4	Fire and Life Safety.....	3-10
3.5	Multihazard Design Interactions.....	3-11
3.6	References.....	3-18
<b>4</b>	<b>Making Schools Safe From Earthquakes</b> .....	<b>4-1</b>
4.1	Introduction .....	4-1
4.2	The Nature and Probability of Earthquakes.....	4-2
4.2.1	Earthquakes and Other Geologic Hazards .....	4-2
4.2.2	Earthquakes: A National Problem .....	4-4
4.2.3	Common Measures of Earthquakes .....	4-8
4.2.4	Determination of Local Earthquake Hazards.....	4-11
4.3	Vulnerability: What Earthquakes Can Do to Schools .....	4-13
4.3.1	Vulnerability of Schools.....	4-13

4.3.2	Earthquake Damage to Schools .....	4-16
4.3.3	Significant School Damage in U.S. Earthquakes .....	4-23
4.3.4	Consequences: Casualties, Financial Loss, and Operational Disruption .....	4-27
4.4	Scope, Effectiveness, and Limitations of Codes .....	4-28
4.4.1	The Background of Seismic Provisions in Building Codes .....	4-29
4.4.2	Seismic Codes and Schools.....	4-29
4.4.3	The Effectiveness of Seismic Codes.....	4-30
4.5	Evaluating Existing Schools for Seismic Risk and Specific Risk Reduction Methods .....	4-31
4.5.1	Rapid Visual Screening.....	4-31
4.5.2	Systems Checklist for School Seismic Safety Evaluation.....	4-32
4.5.3	Seismic Evaluation of Existing Buildings .....	4-37
4.6	Earthquake Risk Reduction Methods .....	4-38
4.6.1	Risk Reduction for New Schools .....	4-39
4.6.2	Risk Reduction for Existing Schools .....	4-49
4.7	The School as a Post-Earthquake Shelter .....	4-55
4.8	References and Sources of Additional Information.....	4-56
4.9	Glossary of Earthquake Terms .....	4-58
<b>5</b>	<b>Making Schools Safe From Flooding .....</b>	<b>5-1</b>
5.1	General Design Considerations .....	5-1
5.1.1	The Nature of Flooding.....	5-2
5.1.2	Probability of Occurrence or Frequency .....	5-4
5.1.3	Flood Characteristics and Loads .....	5-8
5.1.3.1	Hydrostatic Loads.....	5-10
5.1.3.2	Hydrodynamic Loads .....	5-11
5.1.3.3	Debris Impact Loads .....	5-13
5.1.3.4	Erosion and Local Scour.....	5-14
5.1.4	Design Parameters .....	5-15
5.1.4.1	Flood Depth .....	5-15

5.1.4.3	Flood Velocity—Riverine .....	5-19
5.1.4.4	Flood Velocity—Coastal .....	5-19
5.1.5	Flood Hazard Maps and Zones.....	5-20
5.1.5.1	NFIP Flood Maps.....	5-21
5.1.5.2	NFIP Flood Zones .....	5-22
5.1.5.3	Coastal A Zones .....	5-25
5.1.6	Floodplain Management Requirements and Building Codes .....	5-26
5.1.6.1	Overview of the NFIP .....	5-27
5.1.6.2	Summary of the NFIP Minimum Requirements .....	5-28
5.1.6.3	Executive Order 11988 and Critical Facilities .....	5-30
5.1.6.4	Model Building Codes and Standards.....	5-31
5.2	Schools Exposed to Flooding.....	5-33
5.2.1	Identifying Flood Hazards at School Sites .....	5-33
5.2.2	Vulnerability: What Flooding Can Do to Existing Schools.....	5-34
5.2.2.1	Site Damage.....	5-34
5.2.2.2	Structural Damage .....	5-36
5.2.2.3	Nonstructural Damage.....	5-39
5.2.2.4	Utility System Damage .....	5-41
5.2.2.5	Contents Damage .....	5-44
5.3	Requirements and Best Practices in Flood Hazard Areas .....	5-45
5.3.1	Evaluating Risk and Avoiding Flood Hazards .....	5-45
5.3.2	Benefits and Costs: Determining Acceptable Risk.....	5-46
5.3.3	Site Modifications .....	5-48
5.3.4	Elevation Considerations.....	5-50
5.3.5	Dry Floodproofing Considerations .....	5-56
5.3.6	Flood Damage-Resistant Materials .....	5-59
5.3.7	Access Roads .....	5-61
5.3.8	Utility Installations.....	5-61
5.3.9	Potable Water and Wastewater Systems.....	5-63
5.3.10	Storage Tank Installations .....	5-64
5.3.11	Accessory Structures .....	5-64

5.4	Risk Reduction for Existing Schools.....	5-64
5.4.1	Introduction.....	5-64
5.4.2	Site Modifications .....	5-65
5.4.3	Additions .....	5-67
5.4.4	Repairs, Renovations, and Upgrades .....	5-68
5.4.5	Retrofit Dry Floodproofing .....	5-69
5.4.6	Utility Installations.....	5-70
5.4.7	Potable Water and Wastewater Systems.....	5-72
5.4.8	Other Damage Reduction Measures .....	5-72
5.4.9	Drainage Improvements .....	5-73
5.4.10	Emergency Measures .....	5-74
5.5	Schools as Emergency Shelters and Safe Rooms.....	5-75
5.6	Checklist for Vulnerability of Floodprone Sites and Schools.....	5-77
5.7	References and Sources of Additional Information.....	5-83
5.8	Glossary of Flood Protection Terms.....	5-86
<b>6</b>	<b>Making Schools Safe From High Winds .....</b>	<b>6-1</b>
6.1	General Design Considerations .....	6-1
6.1.1	Nature of High Winds .....	6-3
6.1.2	Probability of Occurrence .....	6-4
6.1.3	Wind/Building Interactions.....	6-6
6.1.4	Building Codes.....	6-12
	6.1.4.1    Scope of Building Codes.....	6-13
	6.1.4.2    Effectiveness and Limitations of Building Codes.....	6-14
6.2	Schools Exposed to High Winds .....	6-17
6.2.1	Vulnerability: What High Winds Can Do to Schools .....	6-17
	6.2.1.1    Types of Building Damage .....	6-17
	6.2.1.2    Ramification of Damage .....	6-21
6.2.2	Priorities, Costs, And Benefits: New Schools .....	6-25
	6.2.2.1    Priorities .....	6-25
	6.2.2.2    Cost, Budgeting, and Benefits .....	6-26

6.2.3	Priorities, Costs, and Benefits: Existing Schools.....	6-28
6.2.3.1	Priorities .....	6-28
6.2.3.2	Cost, Budgeting, and Benefits .....	6-29
6.2.4	Evaluating Schools for Risk from High Winds.....	6-31
6.2.4.1	New Buildings.....	6-31
6.2.4.2	Existing Buildings .....	6-32
6.2.4.3	Portable Classrooms.....	6-33
6.3	Requirements and Best Practices in High-Wind Regions .....	6-34
6.3.1	General School Design Considerations .....	6-35
6.3.1.1	Site .....	6-35
6.3.1.2	School Design.....	6-37
6.3.1.3	Construction Contract Administration .....	6-42
6.3.1.4	Post-Occupancy Inspections, Periodic Maintenance, Repair, and Replacement .....	6-43
6.3.1.5	Site and General Design Considerations in Hurricane-Prone Regions .....	6-44
6.3.2	Structural Systems.....	6-46
6.3.2.1	Design Parameters for Structural Systems.....	6-46
6.3.2.2	Design Parameters for Structural Systems in Hurricane-Prone Regions .....	6-52
6.3.3	Building Envelope .....	6-53
6.3.3.1	Exterior Doors.....	6-53
6.3.3.2	Windows and Skylights.....	6-57
6.3.3.3	Windows and Skylights in Hurricane-Prone Regions .....	6-60
6.3.3.4	Non-Load-Bearing Walls, Wall Coverings, and Soffits .....	6-63
6.3.3.5	Non-Load-Bearing Walls, Wall Coverings, and Soffits in Hurricane-Prone Regions.....	6-73
6.3.3.6	Roof Systems.....	6-74
6.3.3.7	Roof Systems in Hurricane-Prone Regions .....	6-86
6.3.4	Nonstructural Systems and Equipment .....	6-94
6.3.4.1	Exterior-Mounted Mechanical Equipment .....	6-94
6.3.4.2	Nonstructural Systems and Mechanical Equipment in Hurricane-Prone Regions .....	6-104
6.3.4.3	Exterior-Mounted Electrical and Communications Equipment.....	6-106

6.3.4.4	Lightning Protection Systems in Hurricane-Prone Regions .....	6-109
6.3.5	Municipal Utilities In Hurricane-Prone Regions.....	6-115
6.3.5.1	Electrical Power .....	6-116
6.3.5.2	Water Service .....	6-117
6.3.5.3	Sewer Service .....	6-118
6.3.6	Post-Design Considerations in Hurricane-Prone Regions.....	6-118
6.3.6.1	Construction Contract Administration .....	6-118
6.3.6.2	Periodic Inspections, Maintenance, and Repair .....	6-118
6.4	Remedial Work on Existing Facilities .....	6-119
6.4.1	Structural Systems.....	6-121
6.4.2	Building Envelope .....	6-122
6.4.2.1	Windows and Skylights.....	6-123
6.4.2.2	Non-Load-Bearing Walls, Wall Coverings, and Soffits .....	6-127
6.4.2.3	Roof Coverings.....	6-128
6.4.3	Exterior-Mounted Equipment.....	6-131
6.4.3.1	HVAC Units, Condensers, Fans, Exhaust Stacks, and Ductwork .....	6-131
6.4.3.2	Antenna (Communications Mast) .....	6-134
6.4.3.3	Lightning Protection Systems.....	6-134
6.5	Occupant Protection Best Practices in Tornado- and Hurricane-Prone Regions .....	6-135
6.6	Checklist For Building Vulnerability of Schools Exposed to High Winds .....	6-139
6.7	References and Sources of Additional Information .....	6-143
6.8	Glossary of High Wind Protection Terms.....	6-147

## Appendix

Appendix A: Acronyms.....	A-1
---------------------------	-----

**Figures**

**Chapter 1**

Figure 1-1: One-room schoolhouse, Christiana, DE, 1923 ..... 1-3

Figure 1-2: High school, New York City, NY, 1929 ..... 1-3

Figure 1-3: Elementary school, Washington, DC, constructed in 1930 ..... 1-4

Figure 1-4: Typical finger plan school, 1940s ..... 1-5

Figure 1-5: Compact courtyard plan, 1960s..... 1-5

Figure 1-6: Fountain Valley High School, Huntington Beach, CA, 1964 ..... 1-6

Figure 1-7: Open enclosure plan teaching area, with movable screens and storage, Rhode Island, 1970 ..... 1-6

Figure 1-8: Typical portable classrooms, 1980s, still in use..... 1-7

Figure 1-9: Elementary school, Fairfield, PA, 1980s..... 1-7

Figure 1-10: Private high school located in a remodeled industrial building, Palo Alto, CA ..... 1-8

Figure 1-11: West High School, Aurora, IL, 2000..... 1-10

Figure 1-12: Elementary school, Oxnard, CA, 2000..... 1-10

Figure 1-13: Design and construction process flow chart..... 1-13

**Chapter 2**

Figure 2-1: Performance-based design flow diagram ..... 2-4

Figure 2-2: Maximum level of damage to be tolerated based on performance groups and magnitude of design event ..... 2-7

Figure 2-3: Relative magnitude and return period for seismic, flood, and wind events..... 2-8

**Chapter 3**

Figure 3-1: Areas where earthquakes are likely to occur on the U.S. mainland. The contour lines indicate the 2-percent probability of exceedance of ground motion accelerations within each contour area (or the “odds” [2-percent] that the accelerations will be exceeded in a 50-year period)..... 3-3

Figure 3-2:	Basic wind speed map from ASCE 7 for Risk Category III and IV buildings and other structures. ASCE 7 is cited in the model building codes and used to select design wind speeds.....	3-4
<b>Chapter 4</b>		
Figure 4-1:	School in Anchorage, AK, 1964, severely damaged by earthquake-induced landslide .....	4-3
Figure 4-2:	States with seismic risk .....	4-5
Figure 4-3:	Examples of national seismic hazard maps.....	4-12
Figure 4-4:	Representative shapes of building code (or design) response spectra for different soils .....	4-12
Figure 4-5:	Ductility .....	4-13
Figure 4-6:	Collapse of portion of nonductile concrete frame school structure, Helena, MT, 1935 .....	4-14
Figure 4-7:	Modular classrooms pushed off their foundations; note stairs at left, Northridge, CA, 1994.....	4-14
Figure 4-8:	Fallen filing cabinets and shelves, Northridge, CA, 1994 .....	4-15
Figure 4-9:	Fallen shop equipment, Coalinga, CA, 1983 .....	4-15
Figure 4-10:	Fallen light fixtures, library, Coalinga, CA, 1983.....	4-16
Figure 4-11:	Fallen heavy lath and plaster ceiling across auditorium seating, Northridge, CA, 1994 .....	4-16
Figure 4-12:	Damage to the John Muir School, Long Beach, CA, 1933 .....	4-17
Figure 4-13:	Damage to shop building, Compton Junior High School, Long Beach, CA, 1933.....	4-17
Figure 4-14:	A dangerous passageway between two buildings, Polytechnic High School, Long Beach, CA, 1933.....	4-18
Figure 4-15:	A heavy corridor lintel ready to fall, Emerson School, Bakersfield, Kern County, CA, 1952.....	4-18
Figure 4-16:	Overtaken shop equipment and failed light fixtures, Kern County, CA, 1952.....	4-19



TABLE OF CONTENTS

---

Figure 4-17: Destroyed exit corridor, Bakersfield, Kern County, CA, 1952 ..... 4-19

Figure 4-18: Typical school damage, Helena, MT, 1935 ..... 4-20

Figure 4-19: The student body president was killed here by falling  
brickwork, Seattle, WA, 1949 ..... 4-21

Figure 4-20: Another dangerous entry collapse, Seattle, WA, 1949 ..... 4-21

Figure 4-21: Collapse of roof over stage, Seattle, WA, 1949..... 4-22

Figure 4-22: Damage to library shelving, Seattle, WA, 1949 ..... 4-22

Figure 4-23: Severe structural damage to the West Anchorage High  
School, Anchorage, AK, 1964 ..... 4-23

Figure 4-24: Brittle failure at nonductile concrete column, West  
Anchorage High School, 1964..... 4-24

Figure 4-25: Ceiling damage, Northridge, CA, 1994..... 4-25

Figure 4-26: Damage to ceramic kiln, including fractured  
gas line, Northridge, CA, 1994 ..... 4-26

Figure 4-27: Line of suspended light fixtures fallen on teacher’s station,  
Northridge, CA, 1994..... 4-26

Figure 4-28: Example of rapid visual screening information form ..... 4-32

Figure 4-29a: Structural and nonstructural elements of a building..... 4-46

Figure 4-29b: Structural and nonstructural elements of a building..... 4-47

Figure 4-30: Suspended ceiling and light fixture bracing and support..... 4-47

Figure 4-31: Bracing tall shelving to the structure ..... 4-48

Figure 4-32: Connection of nonstructural masonry wall to structure to  
permit independent movement ..... 4-48

Figure 4-33: Bracing for existing unreinforced masonry parapet wall ..... 4-48

Figure 4-34: Design strategies for seismic retrofit of existing buildings ..... 4-51

Figure 4-35: Retrofit of B.F. Day Elementary School, Seattle, WA ..... 4-52

Figure 4-36:	Sections and plans of the B.F. Day School: existing at bottom, retrofitted at top. Note that the retrofit has also opened up the basement and first floor to provide large spaces suitable for today’s educational needs .....	4-52
--------------	--	------

## Chapter 5

Figure 5-1:	The riverine floodplain.....	5-4
Figure 5-2:	The floodplain along an open coast .....	5-5
Figure 5-3:	Probability and magnitude .....	5-6
Figure 5-4:	Hydrostatic loads on buildings .....	5-11
Figure 5-5:	Hydrodynamic loads on a building or building element .....	5-11
Figure 5-6:	Definition sketch – coastal wave height and stillwater depth .....	5-16
Figure 5-7:	Velocity as a function of stillwater flood depth .....	5-20
Figure 5-8:	Riverine flood hazard zones .....	5-23
Figure 5-9:	Coastal flood hazard zones .....	5-24
Figure 5-10:	Sample digital FIRM format used for modernized maps.....	5-24
Figure 5-11:	Illustration of the Limit of Moderate Wave Action, which delineates the inland limit of areas referred to as Coastal A Zones.....	5-25
Figure 5-12:	Flooding caused the failure of this road bed.....	5-35
Figure 5-13:	School bus washed away by storm surge .....	5-36
Figure 5-14:	Interior unreinforced masonry walls of the Port Sulphur High School in Louisiana were damaged by hydrostatic loads associated with Hurricane Katrina’s storm surge (2005) .....	5-37
Figure 5-15:	Concrete slab ruptured by hydrostatic pressure (buoyancy) induced by the floodwaters of Hurricane Katrina (2005) .....	5-38
Figure 5-16:	Scour undermined the foundation of St. Paul Catholic School, Pass Christian, LA .....	5-38

Figure 5-17: This parquet wood gymnasium floor was damaged by dimensional changes due to saturation (Hurricane Katrina 2005)..... 5-40

Figure 5-18: Saturation damage extends above the water line in this grade school in Gurnee, IL..... 5-41

Figure 5-19: Although it was anchored and not displaced by floodwaters, this generator was out of service after being submerged (Hurricane Katrina, 2005) ..... 5-43

Figure 5-20: Destroyed computers and peripheral equipment, Nichols Elementary School, Biloxi, MS ..... 5-44

Figure 5-21a: Schematic of typical earthen levee ..... 5-49

Figure 5-21b: Schematic of typical permanent floodwall..... 5-50

Figure 5-22: High school in Bloomsburg, PA, elevated on fill..... 5-53

Figure 5-23: A stemwall foundation elevates the Marion T. Academy above the flood level in Wilmington, DE. .... 5-54

Figure 5-24: School elevated on columns ..... 5-54

Figure 5-25: Typical crawlspace with flood openings..... 5-55

Figure 5-26: Specially designed panels are mounted to block doors, windows, and other openings to keep water from entering the building. .... 5-58

Figure 5-27: Brick facing separated from masonry wall (Hurricane Katrina, 2005)..... 5-60

Figure 5-28: Equipment room with watertight door ..... 5-62

Figure 5-29: A masonry floodwall with multiple engineered openings in Fargo, ND, during flooding in 2001..... 5-67

Figure 5-30: Utility component elevated above flood level ..... 5-71

Figure 5-31: Gravel-filled containers form a barrier to protect the University of Iowa (2008) ..... 5-75

---

**Chapter 6**

Figure 6-1:	Large portions of the roof coverings blew off of this school. Estimated wind speed: Approximately 125 to 130 miles per hour (mph). Hurricane Katrina (Louisiana, 2005) .....	6-2
Figure 6-2:	Hurricane-prone regions and special wind regions .....	6-3
Figure 6-3:	Average number of tornadoes per year (1953-2005) .....	6-5
Figure 6-4:	This high school was damaged by a strong tornado (Plainfield, IL 1990) .....	6-6
Figure 6-5:	Basic wind speeds for Risk Category III and IV buildings and other structures .....	6-8
Figure 6-6:	Wind pressure as a function of wind speed .....	6-9
Figure 6-7:	Relative roof uplift pressures as a function of roof geometry, roof slope, and location on roof, and relative positive and negative wall pressures as a function of location along the wall .....	6-10
Figure 6-8:	Aggregate Blow-off associated with building irregularities. Hurricane Hugo (South Carolina, 1989) .....	6-11
Figure 6-9:	The irregularity created by the stair tower (covered with a metal roof) caused turbulence resulting in wind speed-up and roof damage. Hurricane Andrew (Florida, 1992) .....	6-11
Figure 6-10:	Plan view of a portion of the building in Figure 6-9 showing the use of a corner uplift zone in lieu of a perimeter uplift zone on the low-slope roof in the vicinity of the stair tower .....	6-12
Figure 6-11:	The single-ply roof membrane on this school was torn by a missile. The tear was still unprotected 6 days after it was damaged. A substantial amount of water can enter the building through such a tear, unless the deck is water tight (see Figure 6-13) or a secondary roof membrane is used as discussed in Section 6.3.3.8. Estimated wind speed: 105 to 115 mph. Hurricane Ivan (Florida, 2004) .....	6-15

Figure 6-12: Constructed in 1995, this school was used as a hurricane shelter. The large number of occupants moved from one area of the school to another as water entered various areas of the building due to envelope failures. Estimated wind speed: 105 to 115 mph. Hurricane Ivan (Florida, 2004) ..... 6-17

Figure 6-13: Extensive roof covering and rooftop equipment damage occurred on this school. However, the cast-in-place concrete deck kept most of the water from entering the school. Hurricane Andrew (Florida, 1992) ..... 6-18

Figure 6-14: The outer window panes were broken by aggregate from a built-up roof. Estimated wind speed: 104 mph. Hurricane Hugo (South Carolina, 1989) ..... 6-18

Figure 6-15: Blow-off of metal wall panels allowed wind-driven rain to enter this school. Hurricane Frances (Florida, 2004) ..... 6-19

Figure 6-16: Collapsed unreinforced CMU wall. Hurricane Marilyn (U.S. Virgin Islands, 1995) ..... 6-19

Figure 6-17: The roof and all of the walls of a wing of this elementary school were blown away by a violent tornado. (Oklahoma City, 1999) ..... 6-20

Figure 6-18: This elementary school was composed of several buildings. The building in the foreground collapsed and several others experienced significant structural damage. The buildings further up the hillside are residences. Hurricane Marilyn (U.S. Virgin Islands, 1995) ..... 6-20

Figure 6-19: This portable classroom was blown up against the main school building. Depending upon the type of exterior wall, an impacting portable classroom may or may not cause wall collapse. Hurricane Marilyn (U.S. Virgin Islands, 1995) ..... 6-21

Figure 6-20: This newly-constructed gymnasium had a structural metal roof panel (3-inch trapezoidal ribs at 24 inches on center) applied over metal purlins. The panels detached from their concealed clips. A massive quantity of water entered the school and buckled the wood gym floor. Typhoon Paka (Guam, 1997) ..... 6-22

Figure 6-21: The entire metal deck and steel joist roof structure at this school’s auto shop blew off. Estimated wind speed: 105 to 115 mph. Hurricane Ivan (Florida, 2004) ..... 6-22

Figure 6-22: The metal straps between this portable classroom and the ground anchors were not taut. This classroom is susceptible to being blown off the piers and to overturning. See Figure 6-26 for a robust anchoring system ..... 6-23

Figure 6-23: This old school was used as a hurricane shelter. Structural failure did not occur during this hurricane. However, portions of the roof covering were blown off, rooftop equipment was damaged, and many windows were broken by aggregate from the built-up roof (red arrow). Estimated wind speed: 130 mph. Hurricane Katrina (Mississippi, 2005)..... 6-24

Figure 6-24: This old school was scheduled to be used as a hurricane shelter. Sheltering people in schools that lack sufficient wind and wind-borne debris resistance presents risk of injury or death to occupants. Hurricane Andrew (Louisiana, 1992)..... 6-25

Figure 6-25: Lack of fasteners resulted in blow-off of the HVAC unit, which caused extensive interior water damage and interrupted facility use. Hurricane Marilyn (U.S. Virgin Islands, 1995) ..... 6-28

Figure 6-26: The cementitious wood-fiber deck panels blew off the overhangs and caused a progressive lifting and peeling of the roof membrane. Strengthening (or replacing) inadequately attached roof decks during a reroofing project is both prudent and relatively economical. Estimated wind speed: 120 mph. Hurricane Katrina (Mississippi, 2005)..... 6-30

Figure 6-27: Unlike the portable classroom shown in Figure 6-22, with the thick T-shaped plates and taut turnbuckles, this portable classroom has a robust anchorage to the ground. Hurricane Francis (Florida, 2004)..... 6-33

Figure 6-28: Asphalt shingles and vinyl siding blew off of this portable classroom. This type of wind-borne debris can break unprotected glazing. Hurricane Francis (Florida, 2004)..... 6-34

Figure 6-29: This fallen tree caused minor damage to these portable classrooms. However, had the tree landed on the classroom at the left of the photograph, it could have caused injuries if the building had been occupied. Although portable classrooms are not occupied during hurricanes, they are frequently occupied during thunderstorms, which often topple trees. Estimated wind speed: 105 to 115 mph. Hurricane Ivan (Florida, 2004) ..... 6-36

Figure 6-30: In most of the areas on this roof, the connection of the top nailer to the bottom nailer was the weakest link. However, in a few locations, the connection of the bottom nailer to the roof structure was the weak link (three of the blown-off bottom nailers are shown by the red lines). ..... 6-39

Figure 6-31: Illustration of load path continuity ..... 6-40

Figure 6-32: Dirt and vegetation surrounded this roof drain (red arrow) and impeded drainage. Roof drains should be checked at least annually and cleaned of debris if found. Drains should also be checked prior to hurricane landfall. Hurricane Ike (Texas, 2008) ..... 6-44

Figure 6-33: Open walkways do not provide protection from wind-borne debris. Hurricane Katrina (Mississippi, 2005) ..... 6-46

Figure 6-34: The structure on this school was composed of light gauge metal framing, with a proprietary composite deck system composed of light gauge corrugated metal deck and gypsum board. In addition to the gable end wall failure, the asphalt shingles and underlayment were blown off at the corner of the eave and ridge. Estimated wind speed: 140 to 160 mph. Hurricane Charley (Florida, 2004) ..... 6-47

Figure 6-35: Even though the roof structure blew off, because of the strength and reliability of the screwed deck connections, the decking remained attached to the joists. Hurricane Charley (Florida, 2004) ..... 6-48

Figure 6-36: View looking down at the top of a steel joist after the metal decking blew away. Only a small portion of the deck was well fused to the joist (circled area). Tornado (Oklahoma, 1999) ..... 6-49

Figure 6-37: Looking down at a sidelap of a deck attached with powder-driven pins. The washer at the top pin blew through the deck..... 6-49

Figure 6-38: View looking along a sidelap of a deck attached with powder-driven pins. The right pin does not provide adequate uplift and shear resistance..... 6-49

Figure 6-39: Portions of this waffled precast concrete roof deck were blown off. Typhoon Paka (Guam, 1997) ..... 6-50

Figure 6-40:	Twin-Tee roof panel lifted as a result of the combined effects of wind uplift and pre-tension. Tornado (Missouri, May 2003) .....	6-51
Figure 6-41:	The wind speed was sufficient to collapse this school's canopy, but the speed was not high enough to blow the canopy debris very far. Hurricane Francis (Florida, 2004) .....	6-51
Figure 6-42:	At the school shown in Figure 6-34, wind-borne debris ruptured the proprietary composite deck system composed of light gauge corrugated metal deck and gypsum board. Estimated wind speed: 140 to 160 mph. Hurricane Charley (Florida, 2004) .....	6-53
Figure 6-43:	Door sill pan flashing with end dams, rear leg, and turned-down front leg .....	6-55
Figure 6-44:	Drip at door head and drip with hook at head .....	6-55
Figure 6-45:	Door shoe with drip and vinyl seal (left); neoprene door sweep (right) .....	6-56
Figure 6-46:	Automatic door bottom .....	6-56
Figure 6-47:	Interlocking threshold with drain pan.....	6-57
Figure 6-48:	Threshold with stop and seal.....	6-57
Figure 6-49:	Adjustable jamb/head weatherstripping .....	6-57
Figure 6-50:	Two complete windows, including frames, blew out as a result of an inadequate number of fasteners. Typhoon Paka (Guam, 1997) .....	6-58
Figure 6-51:	View of a typical window sill pan flashing with end dams and rear legs. ....	6-59
Figure 6-52:	Protecting sealant retards weathering and reduces the exposure to wind-driven rain.....	6-59
Figure 6-53:	Plywood panels (black continuous bands) installed after the glass spandrel panels were broken by roof aggregate. Estimated wind speed: 130 mph. Hurricane Katrina (Mississippi, 2005) .....	6-60



Figure 6-54: The red arrow shows a piece of laminated glass that was broken, but remained in the frame to protect the building’s interior. The blue arrow shows unbroken laminated glass. The yellow arrows show granite wall panels. Estimated wind speed: 105 mph. Hurricane Katrina (Louisiana, 2005) ..... 6-61

Figure 6-55: The exterior wall stopped just above the soffit (red arrows). After the metal soffit panels blew away, wind-driven rain blew into the attic space, which saturated the fiberglass batt insulation and caused the ceiling boards to collapse. Estimated wind speed: 130 mph. Hurricane Katrina (Mississippi, 2005) ..... 6-63

Figure 6-56: The red arrows show the original location of a CMU wall that nearly collapsed following a rolling door failure. Estimated wind speed: 140–160 mph. Hurricane Charley (Florida, 2004) ..... 6-64

Figure 6-57: Although uncommon for schools, precast wall panels were attached to the structural frame of this school. This type of wall typically offers excellent wind performance. Note the roof covering damage and displaced gas line. Estimated wind speed: Approximately 125–130 mph. Hurricane Katrina (Louisiana, 2005) ..... 6-65

Figure 6-58: The four ties shown by the red arrows were not embedded into the mortar. Estimated wind speed: 105 mph. Hurricane Katrina, (Mississippi, 2005) ..... 6-66

Figure 6-59: Water leaked inside along the base of the brick veneer walls (red arrow). Estimated wind speed: 115 mph. Hurricane Katrina (Louisiana, 2005) ..... 6-67

Figure 6-60: Typical EIFS assemblies ..... 6-67

Figure 6-61: EIFS blow-off near a wall corner. At one area, the metal fascia was also blown in ..... 6-68

Figure 6-62: At this EIFS failure, the screws attaching the gypsum board (yellow colored material) were too far apart (red circle). Additionally, at the board joint, the screws were too close to the board edge (blue circle). In this area, the screws were spaced at 4½, 4, 6, 6, 9, and 9½ inches on center. Also, the adhesive between the gypsum board and MEPS was applied in rows rather than continuously over the gypsum board. Estimated wind speed: 120 mph. Hurricane Katrina (Mississippi, 2005) ..... 6-68

Figure 6-63:	The stucco wall failure was caused by inadequate attachment between the stud tracks and the building's structure. All of the metal stud framing within the red circle blew away. The arrow shows a bottom stud track that detached and pulled away from the building. Estimated wind speed: 110–125 mph. Hurricane Ivan (Florida, 2004) .....	6-69
Figure 6-64:	The loss of metal wall panels allowed a substantial amount of wind-driven rain to penetrate into the classroom. Estimated wind speed: 105–115 mph. Hurricane Ivan (Florida, 2004) .....	6-70
Figure 6-65:	Blow-off of metal fascia panels due to inadequate attachment of wood furring to the CMU wall. Estimated wind speed: 85–95 mph. Hurricane Ivan (Florida, 2004) .....	6-71
Figure 6-66:	This cement fiber siding was attached with blind nails (red circle). Because of the high design wind speed, face nails should have been used (blue circle). Hurricane Francis (Florida, 2004) .....	6-72
Figure 6-67:	Three of the panel ribs opened up (one to the right of the blue arrow and two to the left). The LPS conductor serving the air terminal (red arrow) ran underneath the ridge flashing. Estimated wind speed: 105–115 mph. Hurricane Ivan (Florida, 2004) .....	6-75
Figure 6-68:	The blown off insulation (red arrow) may have initiated blow-off of the roof membrane. Estimated wind speed: 105–115 mph. Hurricane Ivan (Florida, 2004) .....	6-77
Figure 6-69:	The orientation of the membrane fastener rows led to blow-off of the steel deck. Hurricane Marilyn (U.S. Virgin Islands, 1995) .....	6-78
Figure 6-70:	The ink pen shows an opening that the wind can catch to cause lifting and peeling of the membrane. ....	6-79
Figure 6-71:	The metal edge flashing on this building disengaged from the continuous cleat and the vertical flange lifted. Hurricane Hugo (South Carolina, 1989) .....	6-80
Figure 6-72:	The coping blew off because of inadequate attachment of the cleats. Estimated wind speed: 92 mph. Hurricane Ike (Texas, 2008) .....	6-80

Figure 6-73: Both vertical faces of the coping were attached with exposed fasteners instead of concealed cleats. Typhoon Paka (Guam, 1997) ..... 6-81

Figure 6-74: Because this gutter was not attached to the bracket, wind lifted the gutter along with the metal edge flashing that lapped into the gutter. Bracket fasteners are indicated by the red arrows. Hurricane Francis (Florida, 2004) ..... 6-82

Figure 6-75: The original modified bitumen membrane was blown away after the gutter lifted in the area shown by the red arrow (the black membrane is a temporary roof). Hurricane Francis (Florida, 2004) ..... 6-82

Figure 6-76: At this gutter, a fastener connected the bracket to the gutter. Note: To avoid leakage at the fasteners between the bracket and gutter, the bracket should extend near or to the top of the gutter so that the fastener would be above the waterline. Estimated wind speed: 95 mph. Hurricane Ike (Texas, 2008) ..... 6-83

Figure 6-77: Sheet metal straps were attached to an existing gutter that lacked sufficient uplift resistance. .... 6-84

Figure 6-78: Blow-off of this downspout resulted in glazing breakage. Estimated wind speed: 105–115 mph. Hurricane Ivan (Florida, 2004) ..... 6-85

Figure 6-79: If mechanically attached base flashings have an insufficient number of fasteners, the base flashing can be blown away. Hurricane Andrew (Florida, 2004) ..... 6-85

Figure 6-80: The secondary membrane prevented significant leakage into the building after the copper roof blew off. Hurricane Andrew (Florida, 1992) 6-87

Figure 6-81: Although a missile cut into the SPF, the roof was still watertight. The ink pen (blue arrow) shows the relative size of the impact area. Estimated wind speed: 110 mph. Hurricane Ike (Texas, 2008) ..... 6-88

Figure 6-82: Significant interior water damage and facility interruption occurred after the standing seam roof blew off. Hurricane Marilyn (U.S. Virgin Islands, 1995) ..... 6-89

Figure 6-83: Brittle roof coverings, like slate and tile, can be broken by missiles, and tile debris can break other tiles. Estimated wind speed: 140–160 mph. Hurricane Charley (Florida, 2004) ..... 6-90

Figure 6-84	These wire-tied tiles were installed over a concrete deck. The failure was attributed to lack of vertical restraint, which allowed the tiles to lift and then be broken when they slammed back down onto the deck. Typhoon Paka (Guam, 1997) .....	6-91
Figure 6-85:	This mechanically attached single-ply membrane progressively tore after being cut by wind-borne debris. Hurricane Andrew (Florida, 1992) .....	6-91
Figure 6-86:	A continuous peel-stop bar over the membrane may prevent a catastrophic progressive failure if the edge flashing or coping is blown off. (Modified from FEMA 55, 2000) .....	6-92
Figure 6-87:	Several rubber walkway pads were blown off the single-ply membrane roof. Estimated wind speed: 130 mph. Hurricane Katrina (Mississippi, 2005).....	6-93
Figure 6-88:	Base flashing protected by metal wall panels attached with exposed screws. Estimated wind speed: 120 mph. Hurricane Katrina (Mississippi, 2005).....	6-93
Figure 6-89:	This gooseneck was attached with only two small screws. Emergency repairs had not been made at the time this photograph was taken, which was 5 days after the hurricane struck. A substantial amount of water was able to enter the school. Hurricane Francis (Florida, 2004) .....	6-94
Figure 6-90:	Although this 18,000-pound HVAC unit was attached to its curb with 16 straps, it blew off the building during Hurricane Ivan. (Florida, 2004) .....	6-95
Figure 6-91:	The gooseneck on this building remained attached to the curb, but the curb detached from the deck. Typhoon Paka (Guam, 1997) .....	6-97
Figure 6-92:	Cowlings blew off two of the three fans. Note also the loose LPS conductors and missing walkway pad (red arrow). Estimated wind speed: 140–160 mph. Hurricane Charley (Florida, 2004).....	6-98
Figure 6-93:	Cables were attached to prevent the cowling from blowing off. Typhoon Paka (Guam, 1997).....	6-98

Figure 6-94: These condensers were blown off their sleepers. Displaced condensers can rupture roof membranes and refrigerant lines. Estimated wind speed: 120 mph. Hurricane Katrina (Mississippi) ..... 6-99

Figure 6-95: This condenser had supplemental attachment straps (see red arrows). Typhoon Paka (Guam, 1997) ..... 6-99

Figure 6-96: Failure of vibration isolators that provided lateral resistance but no uplift resistance caused equipment damage. A damaged vibration isolator is shown in the inset. Estimated wind speed: 120 mph. Hurricane Katrina (Mississippi, 2005)..... 6-100

Figure 6-97: Guyed flue blew over (red arrow indicates one of the guys). Estimated wind speed: 92 mph. Hurricane Ike (Texas, 2008) ..... 6-101

Figure 6-98: The school shown in Figure 6-63 also had an access panel blow off. Blown-off panels can puncture roof membranes, break glazing, and cause injury. Estimated wind speed: 85–95 mph. Hurricane Ivan (Florida, 2004) ..... 6-101

Figure 6-99: The school shown in Figures 6-64 and 6-98 also experienced gas line rupture (shown by the lines dangling over the side of the building). Estimated wind speed: 85–95 mph. Hurricane Ivan (Florida, 2004) ..... 6-102

Figure 6-100: At a periodic gas line support on this roof, a steel angle was welded to a pipe that was anchored to the roof deck. A strap looped over the gas line and was bolted to the support angle. Such a connection provides resistance to lateral and uplift loads. .... 6-102

Figure 6-101: These two condensate drain lines detached from their HVAC units. They had not been anchored to the roof. Estimated wind speed: 125 mph. Hurricane Katrina (Mississippi, 2005) ..... 6-103

Figure 6-102: Equipment screen panels can puncture roof membranes, break glazing, and cause injury. Estimated wind speed: 105–115 mph. Hurricane Ivan (Florida, 2004) ..... 6-104

Figure 6-103: This exhaust fan was impacted by wind-borne debris. Although it is often impractical to place all equipment such as fans in penthouses, doing so to the extent possible avoids debris damage. Estimated wind speed: 130 mph. Hurricane Katrina (Mississippi, 2005) ..... 6-105

Figure 6-104:	Leaf debris and ponding near a scupper (red and blue arrows). The yellow arrow indicates a piece of coping that blew off an upper roof shown in Figure 6-71. Estimated wind speed: 92 mph. Hurricane Ike (Texas, 2008) .....	6-106
Figure 6-105:	Collapsed light fixtures caused by severe corrosion (see inset). Estimated wind speed: 105–115 mph. Hurricane Ivan (Florida, 2004).....	6-107
Figure 6-106:	The collapse of the antenna tower at this school caused progressive peeling of the roof membrane. Also note that the exhaust fan blew off the curb, but the high parapet kept it from blowing off the roof. Hurricane Andrew (Florida, 1992) .....	6-108
Figure 6-107:	Common anchoring method for satellite dish. Estimated wind speed: 85–95 mph. Hurricane Ivan (Florida, 2004) .....	6-109
Figure 6-108:	A satellite dish anchored similarly to that shown in Figure 6-106 was blown off this five-story building. Estimated wind speed: 140–160 mph. Hurricane Charley (Florida, 2004) .....	6-109
Figure 6-109:	An air terminal (red arrow) debonded from the roof. Even though the school had a tough membrane (modified bitumen), the displaced air terminal punctured the membrane in two locations (blue arrows). Hurricane Charley (Florida, 2004) .....	6-110
Figure 6-110:	View of an end of a conductor that became disconnected. Estimated wind speed: 130 mph. Hurricane Katrina (Mississippi, 2005) .....	6-110
Figure 6-111:	This conductor connector was adhered to the coping. The conductor deformed the connector prongs under wind pressure, and pulled away from the connector. Estimated wind speed: 130 mph. Hurricane Katrina (Mississippi, 2005).....	6-111
Figure 6-112:	This conductor was attached to the coping with a looped connector. Estimated wind speed: 130 mph. Hurricane Katrina (Mississippi, 2005).....	6-112
Figure 6-113:	Plan showing conductor attachment .....	6-112
Figure 6-114:	Use of intermittent membrane flashing strips to secure an LPS conductor, as illustrated in Figure 6-113 .....	6-113

Figure 6-115: Adhesively attached conductor connector that does not use prongs ..... 6-113

Figure 6-116: If conductors detach from the roof, they are likely to pull out from pronged splice connectors. Estimated wind speed: 90–100 mph. Hurricane Charley (Florida, 2004) ..... 6-114

Figure 6-117: Bolted splice connectors are recommended to prevent free ends of connectors from being whipped around by wind. Estimated wind speed: 130 mph. Hurricane Katrina (Mississippi, 2005) ..... 6-115

Figure 6-118: In lieu of permanent on-site emergency generators, portable generators can be an economical way to provide electrical power to schools used as hurricane recovery centers. Estimated wind speed: 108 mph. Hurricane Ike (Texas, 2008) ..... 6-116

Figure 6-119: The tree shown by the red line nearly fell on the emergency generator (red arrow). Estimated wind speed: 110 mph. Hurricane Ike (Texas, 2008) ..... 6-117

Figure 6-120: The roof and a portion of the EIFS on this 5-year-old building blew off. Water leaked into the floor below. The floor was taken out of service for more than a month. Estimated wind speed: 130 mph. Hurricane Katrina (Mississippi, 2005) ..... 6-119

Figure 6-121: The cementitious wood-fiber deck panels blew off of much of the overhang at this school. Deck panel failure resulted in lifting and peeling of the roof system over a large area, exposure of the decking in the area shown by the blue arrows, and extensive interior water infiltration. Estimated wind speed: 105–115 mph. Hurricane Ivan (Florida, 2004) ..... 6-121

Figure 6-122: The steel truss superstructure installed on this school as part of a steep-slope conversion blew away because of inadequate attachment. Hurricane Marilyn (U.S. Virgin Islands, 1995) ..... 6-122

Figure 6-123: Wind pressure caused the window frames on the upper floors to fail (red arrow). Estimated wind speed: 130 mph. Hurricane Katrina (Mississippi, 2005) ..... 6-123



Figure 6-124: On-site water-spray testing in accordance with ASTM E 1105 can be used to evaluate wind-driven rain resistance. Older window assemblies such as the ones at this school are often quite susceptible to leakage. Estimated wind speed: 125 mph. Hurricane Katrina (Mississippi, 2005) .....	6-124
Figure 6-125: This school has accordion shutters. Estimated wind speed: 105–115 mph. Hurricane Ivan (Florida, 2004) .....	6-125
Figure 6-126: A metal panel shutter. Hurricane Georges (Puerto Rico, 1998) .....	6-125
Figure 6-127: Polycarbonate shutters were temporary screwed to the doors and wall adjacent to the window opening. An advantage of polycarbonate is its translucence, which allows daylight to enter the building without removing the shutters. Hurricane Francis (Florida, 2004) .....	6-126
Figure 6-128: This school has roll-down shutters. The toggle in the red circle allows the shutter to be manually raised. Estimated wind speed: 130–140 mph. Hurricane Charley (Florida, 2004) .....	6-126
Figure 6-129: Collapsed unreinforced masonry parapet. Greensburg Tornado (Kansas, 2007) .....	6-127
Figure 6-130: View of a 5-foot by 5-foot negative pressure chamber used to evaluate roof system uplift resistance. ....	6-128
Figure 6-131: The built-up roof on this school was blown off after a few of the rotted wood planks detached from the joists. Estimated wind speed: 120 mph. Hurricane Katrina (Mississippi, 2005) .....	6-129
Figure 6-132: The nailer (red arrow) blew off an upper roof and landed on the roof below. The nailer was anchored to a brick wall. Some of the anchors pulled out of the brick, and some of the bricks blew away with the nailer. Estimated wind speed: 105–115 mph. Hurricane Ivan (Florida), 2004 .....	6-130
Figure 6-133: Failed base flashing adhered directly to the brick parapet. Estimated wind speed: 105 mph. Hurricane Katrina (Louisiana, 2005) .....	6-130



Figure 6-134: During a reroofing project a slot was cut in the plywood deck in order to allow air to flow from the attic to a new continuous ridge vent. The cutting depth of the saw was not adjusted for the thickness of the deck. The top 1½ inch of each truss and a portion of the metal nailing plate was inadvertently cut. .... 6-131

Figure 6-135: To strengthen attachment of this HVAC unit, robust pipe anchors were attached to the deck and cables with turnbuckles installed. .... 6-132

Figure 6-136: At this school, the hood on this HVAC unit was inadequately attached. A strap between the hood and unit can be economically installed to avoid this problem. Estimated wind speed: 110 mph. Hurricane Ike (Texas, 2008) ..... 6-132

Figure 6-137: These condensers were simply mounted on wood sleepers that rested on the roof surface. Note the damaged exhaust stacks and missing rain caps (red oval). Estimated wind speed: 105 mph. Hurricane Katina (Mississippi, 2005) ..... 6-133

Figure 6-138: Two large openings (red rectangle and inset) through the roof were left after the ductwork blew away. Estimated wind speed: 130 mph. Hurricane Katrina (Mississippi, 2005) ..... 6-134

Figure 6-139: The antenna collapsed and was whipped back and forth across the roof membrane. Hurricane Andrew (Florida, 1992) ..... 6-135

Figure 6-140: Greensburg Tornado (Kansas, 2007) ..... 6-136

Figure 6-141: A violent tornado showered the roof with missiles (Oklahoma, 1999) ..... 6-136

Figure 6-142: Frequency of recorded EF3, EF4, and EF5 tornadoes (1950–1998) ..... 6-137

Figure 6-143 : Unreinforced masonry walls and hollow-core concrete roof planks collapsed. Enterprise Tornado (Alabama, 2007) ..... 6-139

---

## Tables

### Chapter 2

Table 2-1:	Combinations of structural and nonstructural seismic performance.....	2-12
------------	---	------

### Chapter 3

Table 3-1:	HAZUS-MH earthquake, hurricane, and flood losses (all values are in \$1,000s—2002 valuation) .....	3-8
------------	--	-----

Table 3-2:	HAZUS-MH estimated losses by percentage of school building and contents inventory .....	3-9
------------	---	-----

Table 3-3:	Multihazard design system interactions .....	3-12
------------	--	------

### Chapter 4

Table 4-1:	Known historic (1558–1989) earthquakes in 47 U.S. States .....	4-10
------------	--	------

Table 4-2:	School seismic safety evaluation checklist.....	4-33
------------	---	------

Table 4-3:	Roofing maintenance and repair/re-roofing .....	4-54
------------	---	------

### Chapter 5

Table 5-1:	ASCE/SEI 24 provisions related to the elevation of schools .....	5-33
------------	--	------

Table 5-2:	Classes of flood damage-resistant materials.....	5-59
------------	--	------

Table 5-3:	Checklist for building vulnerability of floodprone schools.....	5-77
------------	---	------

### Chapter 6

Table 6-1:	Number of #12 screws for base case attachment of rooftop equipment .....	6-96
------------	--	------

Table 6-2:	Checklist for building vulnerability of schools exposed to high winds.....	6-140
------------	--	-------





## Design Guide

for Improving School Safety  
in Earthquakes, Floods, and High Winds

# 1

# An Overview of the School Design and Construction Process

## 1.1 Introduction

**T**his chapter presents an overview of the school building to provide a context for the chapters that follow. Every building is unique and school designs vary greatly; however, the purpose of schools, their occupancy, their economic basis, and their role in society dictate certain common features that distinguish them from other building types.

A summary of the national public school inventory is also presented (i.e., the number of students housed and the number of schools included) and projections of future needs are outlined. The sections that follow describe school design of the past, because many older schools are still in use and must be renovated periodically to meet today's needs, and current school design with some trends and ideas that might influence the design of future schools.

## 1.2 School Construction: The National Picture

In 2005, the estimated value of the nation's public school inventory was well over \$361.6 billion.<sup>1</sup> In 2009, of the almost 98,800 public elementary and secondary schools, 31 percent were located in small towns and rural areas and served 43 percent of the students, while 69 percent were located in cities and suburban areas and served 57 percent of the students (U.S. Department of Education, 2009).

The total number of schools in the U.S. increased by 10,600 between 1997 and 2007 (U.S. Department of Education, 2009). More than half of all schools are at least 40 years old and, even with minor renovations, many

The purpose of schools, their occupancy, their economic basis, and their role in society dictate certain common features that distinguish them from other building types.

have passed their prime in terms of adaptability to modern teaching methods and tools (e.g., computers, in-class electronic information displays, and group learning activities). Almost all States require school facilities to be replaced with new construction once renovation costs reach a specified level (usually 60 percent).<sup>2</sup> Estimates from the late 1990s

indicated approximately \$100 to over \$300 billion would be needed to bring our nation's schools up to conditions considered to meet then-current standards.

In 2001, the decade-long growth in kindergarten to grade 12 (K–12) new school construction peaked while deferred maintenance and poor construction quality of many post-World War II schools resulted in a huge renovation demand. From 1999 through 2008, the National Clearinghouse for Educational Facilities reported that \$298.16 billion was spent on the construction of nearly 15,000 elementary, middle, and high schools (National Clearinghouse for Educational Facilities, 2010).

## 1.3 Past School Design

Schools are typically in use for long periods of time. As a result, even today, instruction continues in facilities that were designed and constructed at the beginning of the 20th century. Early 20th-century school design was based on late 19th-century models and few design changes were implemented until after World War II. Schools ranged from one-room rural school houses to major symbolic civic

1 Conservative estimate based upon elementary and secondary school averages developed with the help of Paul Abramson, President of Stanton Leggett & Associates, Education Consultants.

2 Use of this estimate as a decision tool was developed by Basil Castaldi, *Education Facilities, Planning, Modernization and Management* (1994).

structures in large cities (Figures 1-1 and 1-2). Many inner city schools were more modest, inserted into small sites on busy streets and constrained by budget limitations (Figure 1-3).



Figure 1-1:  
One-room schoolhouse,  
Christiana, DE, 1923



Figure 1-2:  
High school, New York  
City, NY, 1929

The typical city school was one to three stories in height and consisted of rows of classrooms on either side of a wide, noisy corridor lined with metal lockers. Typical outdoor recreational areas were asphalt play courts and rooftops. The larger schools sometimes had libraries, special rooms for art, science, and shop, and auditoriums.

The construction surge to meet the demands of the post-war baby boom was primarily a suburban development. Much larger sites were available, buildings were one or two stories in height, auditoriums became multi-use facilities, and large parking lots appeared.



Figure 1-3:  
Elementary school,  
Washington, DC,  
constructed in 1930



Despite the growth of suburban construction, the fundamental design with classrooms along double-loaded corridors did not change very much. However, in warm climates, the one-story “finger plan” school, typically constructed of wood and a small quantity of steel, was both economical and less institutional in feel. For this design, the noisy double-loaded corridor is replaced by a covered walkway, often open to the air, with the classrooms on one side and a grassed court on the other (Figure 1-4). The cross-section diagram in Figure 1-4 shows the simple and effective means this configuration allowed for day lighting and ventilation. Compact versions of these plans appeared as schools became larger and sites smaller (Figure 1-5).

Historically, inner-city high schools have been large facilities, housing 2,000 to 3,000 students (Figure 1-6). In the 1960s and 1970s, educational methods such as team teaching prompted large open classrooms with poor acoustics (Figure 1-7). Some of these new large high schools were built as air-conditioned enclosures, with many windowless classrooms, in buildings that resembled the shopping malls that were replacing the main street retail centers (Figure 1-7). At the same time, many schools were expanded by adding classrooms to accommodate increasing enrollments. Although portable classrooms were originally intended as temporary space, many are now used as permanent classrooms (Figure 1-8).

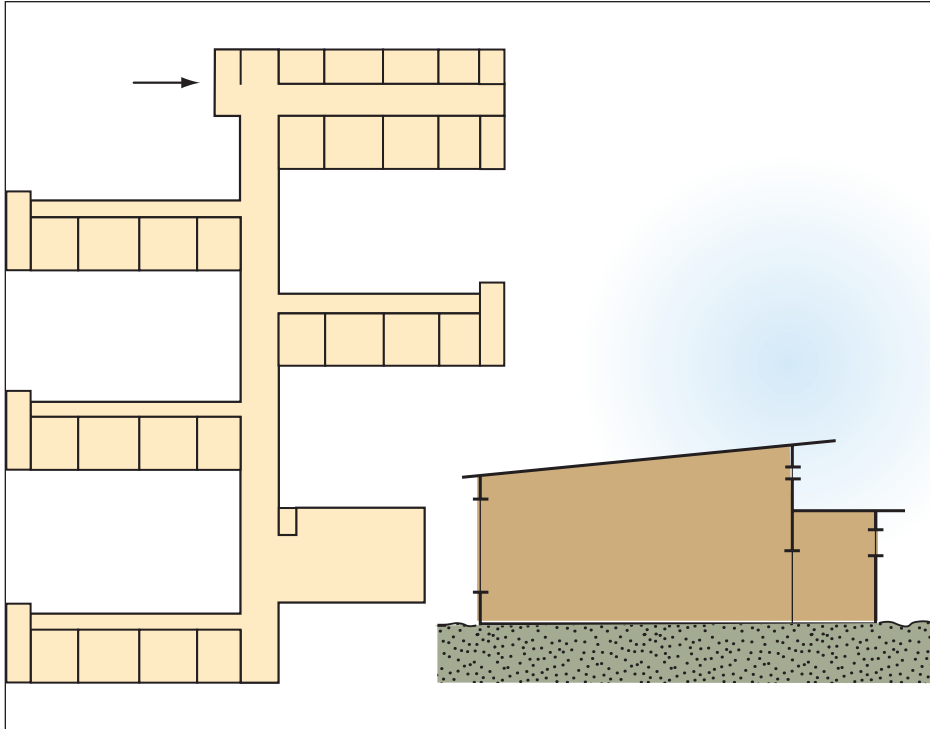

Figure 1-4:  
Typical finger plan  
school, 1940s

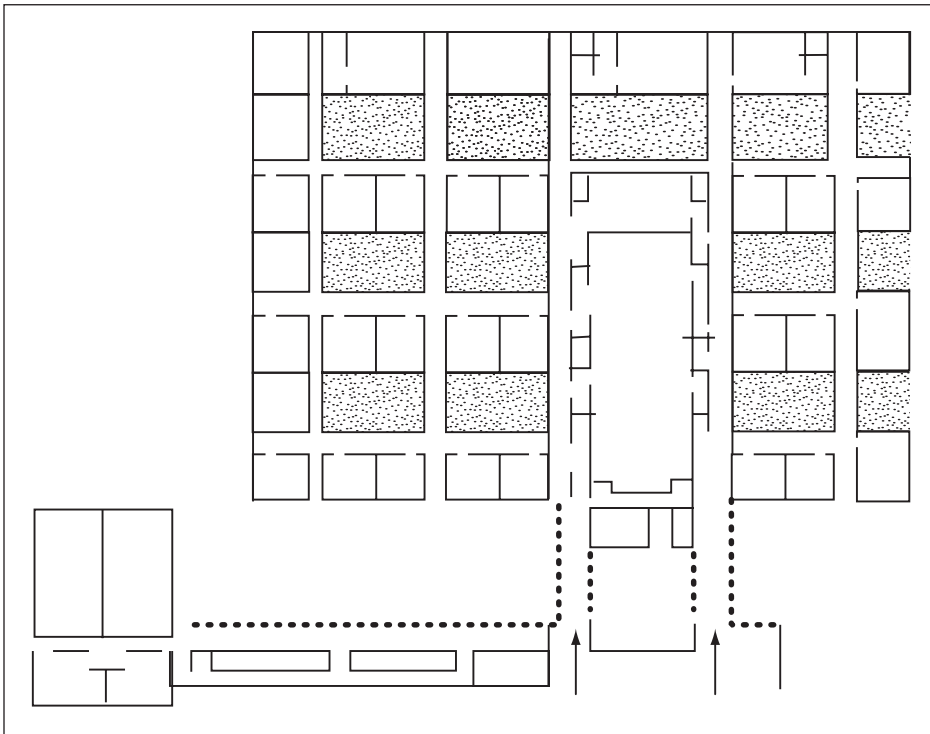

Figure 1-5:  
Compact courtyard  
plan, 1960s



Figure 1-6:  
Fountain Valley High School, Huntington Beach, CA, 1964



Figure 1-7:  
Open enclosure plan teaching area, with movable screens and storage, Rhode Island, 1970

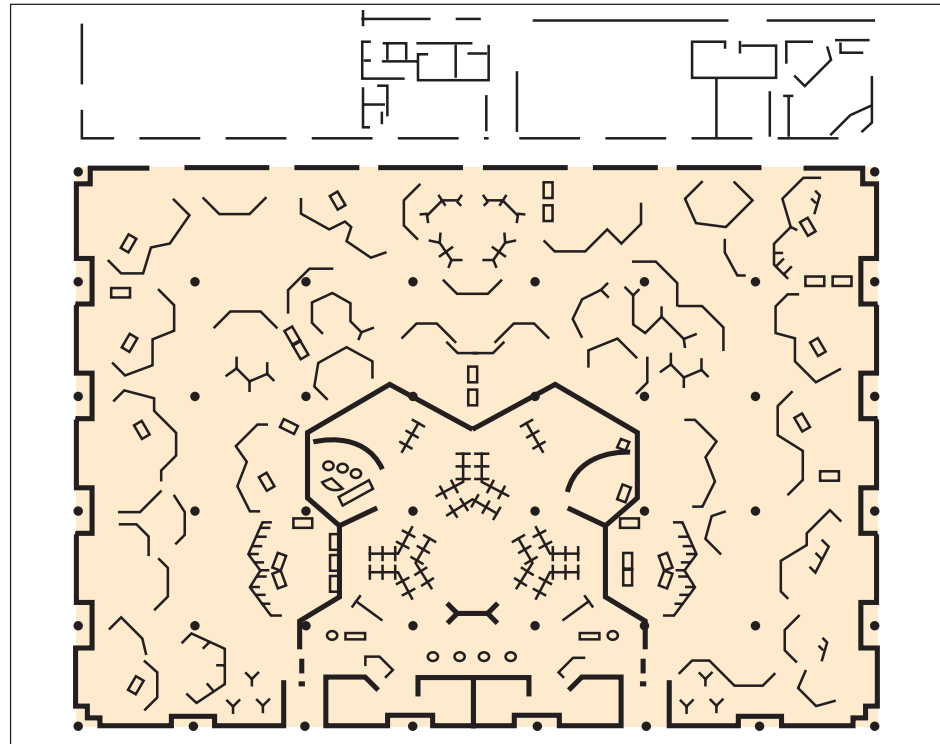



Figure 1-8:  
Typical portable  
classrooms, 1980s, still  
in use

Schools built in the 1980s and 1990s assumed a wide variety of forms, often combining classrooms into clusters and focusing on providing an attractive learning environment (Figure 1-9). However, demographic needs, shortage of affordable land, and limited construction budgets also resulted in some conversions of existing buildings not originally intended for educational purposes (Figure 1-10). Note the exterior cross bracing for the converted industrial building in Figure 1-10. The building required extensive retrofitting to meet California's seismic requirements for schools.



Figure 1-9:  
Elementary school,  
Fairfield, PA, 1980s

Figure 1-10:  
Private high school  
located in a remodeled  
industrial building, Palo  
Alto, CA



## 1.4 Present School Design

**A**t the beginning of the 21st century, evolving social, economic, and educational concerns prompted a number of changes in school design. New design goals have begun to emerge, though some of the following have always been considered:

- The building should provide for health, safety, and security.
- The learning environment should enhance teaching and learning and accommodate the needs of all learners.
- The learning environment should serve as a center for the community.
- The learning environment should result from a planning/design process that involves all stakeholders.
- The learning environment should allow for flexibility and adaptability to changing needs.
- The learning environment should make effective use of all available resources.

These goals have lead, in turn, to a number of current design principles, including:

- Design for protection against natural hazards
- Design with increased attention to occupant security
- Design with increased use of day lighting and comfort control
- Design for durability

- Long-life/loose-fit approach: design for internal change and flexibility
- Design for sustainability (also referred to as environmentally friendly construction, green construction, and green building)

Some new schools already respond to these needs and, indeed, their originators, school districts, communities, and designers are among those defining school design for the future. Some of the changes are the result of ideology and analysis. Other changes reflect efforts to provide an improved learning environment and enhanced learning resources in an economy with increasingly limited funding for school construction. Some school districts will be faced with having to provide a minimal learning environment with buildings of the utmost simplicity, while meeting the requirements for health, safety, and security.

In recent years, building methods that recognize “green” building practices for both new construction and renovation have become increasingly available. One example is the California Green Building Standards Code, which became effective in August 2009 (California Building Standards Commission, 2009). As interest in sustainability increases and more school districts seek to implement various aspects of green building design, construction, and maintenance practices, design professionals are incorporating new approaches to make buildings more energy efficient and sustainable with respect to impacts on the environment. These approaches are already having a significant influence on building construction, and are likely to have greater influence as proven, innovative designs are incorporated into regular practice. A wealth of guidance on green design and construction practices that is specific to schools—both for new construction and renovations—is being developed, and rating systems are being strengthened and utilized to better guide those involved in the process to more sustainable solutions.

## 1.5 Future School Design

**S**chools will continue to vary widely in size. However, even in many suburban areas suitable land has become increasingly scarce and expensive. Sprawling one-story campuses will become less common and more schools will be more compact and multi-story (Figure 1-11). The desire for more humanistic environments and the rejection of traditional school plans will likely result in more imaginative and more complex layouts (Figure 1-12), while the move to re-populate inner cities may result in the construction of dense and compact schools. Despite evidence of a trend towards larger buildings, many educational researchers believe that students improve their learning skills best in smaller schools.



Figure 1-11:  
West High School,  
Aurora, IL, 2000

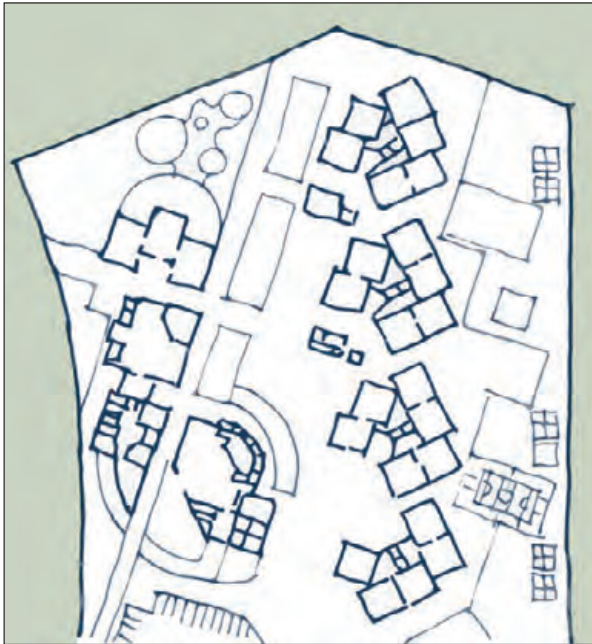

Figure 1-12:  
Elementary school,  
Oxnard, CA, 2000

Although constructing more small schools may be economically unrealistic, methods of organization are being explored that provide some of the benefits of small size within a large physical complex. Some schools are organized into “learning academies” for each grade, with classrooms that can expand and contract, along with other activity rooms of various sizes.

Other researchers believe that the conventional library will disappear. The trend in many new schools is for the library to take the form of a multi-media center and material collections, including laptop computers that are distributed from mobile units to “classroom clusters.”

Schools are increasingly seen as community resources that go beyond their primary educational functions. Adult education and community

events now take place on evenings, weekends, and throughout traditional vacation periods. These uses provide affordable means to enhance community service resources by maximizing a facility’s utilization.

There is a growing awareness of the importance of recognizing natural hazards that may affect schools. The likelihood of earthquakes, floods, hurricanes, and tornadoes will continue to be, at some locations, a source of worry and fear. Aside from protecting students, schools in earthquake-prone regions are often used as post-earthquake shelters and schools in hurricane- and tornado-prone regions are also used as shelters. In California, the State’s Field Act, enacted in 1933 following the Long Beach earthquake, requires public schools to be designed by a licensed architect or engineer and the Department of the State Architect is required to check plans and inspect construction. Elsewhere, floods and high winds occur with sufficient frequency that resistance to their effects must be addressed by knowledgeable designers and good construction practices.

## 1.6 The Design and Construction Process

Certain basic steps are necessary and certain basic procedures must be followed for any school construction program. The actual procedures followed will vary greatly in scope between the design of a single small elementary school and the development of a multi-school program that involves both new and remedial construction. Review and regulation procedures by outside agencies will also vary. Internal decisions by a school district regarding the design and construction process (e.g., conventional architect design and competitive construction bid, design/build, or construction manager) will affect the scope and timing of some of the activities.

Regardless of the size and scope of a project, a number of planning steps should be taken by school districts and their design teams. For a small project, the steps may entail relatively informal meetings among a few district staff, the school board, and others. For a larger program, formal procedures should be established to include the following steps.

Many of the steps in the design and construction process are appropriate when evaluating existing schools for proposed renovation. Specific factors to consider when evaluating seismic, flood, and wind hazards at existing schools are described in this design guide.

- Conduct an in-house assessment of the educational needs, often with the assistance of a public education committee and consultants. Contributions of the committee continue throughout the programming and design process, and may involve acquiring input from specialists as necessary at different stages for a large program.
- Determine the size and scope of the proposed program. (In a small district, an architect may be employed to assist the school district with this task; the architect may later become the design architect.)
- Conduct a siting assessment to determine the size and availability of sites (and lease/purchase as necessary) and to identify avoidable site constraints such as the presence of flood hazard areas, wetlands, and steep slopes.
- Develop educational specifications by in-house staff and/or consultants.
- Conduct a financial assessment.
- Identify financial resources, including alternative sources of funding (e.g., State and Federal programs, local taxes, bond issues).
- Ensure funding is made available (e.g., obtain State grants or pass bond issue).

- Appoint district building program management staff (appointed officials or a committee).
- Determine the design and construction process (i.e., conventional design and bid, design/build, or construction management).
- Select and hire architects and other special design consultants or design/build team members; the timing of hiring will vary depending on the number of projects, whether programming is involved, and other variables.
- Develop building programs, including building size, room size, equipment, and environmental requirements; this may be done by in-house staff and/or architects or independent program consultants.
- Appoint a district staff and public stakeholders committee for the design phase.
- Develop designs (architects) and cost estimates. Hold public meetings with architects and encourage public input into the design; conduct district progress reviews.
- Complete design and conduct district review of contract documents.
- Submit construction documents to permitting agencies for review and approval.
- Submit documents to building department and other required agencies.
- Select the contractor (bidding) or finalize design/build or construction management contracts.
- Begin school construction.
- Administer construction contract.
- Initiate architect observations and inspections as required.
- Complete school construction.
- Obtain occupancy permit from the building department.
- Obtain architect acceptance.
- Obtain school district acceptance.
- Commission and occupy school.

The sequence of the above steps may vary, depending on the complexity of the program, and some steps may be implemented simultaneously. The flow chart in Figure 1-13 illustrates the typical process and identifies how specific activities related to design for natural hazards fit into the general planning and design process.

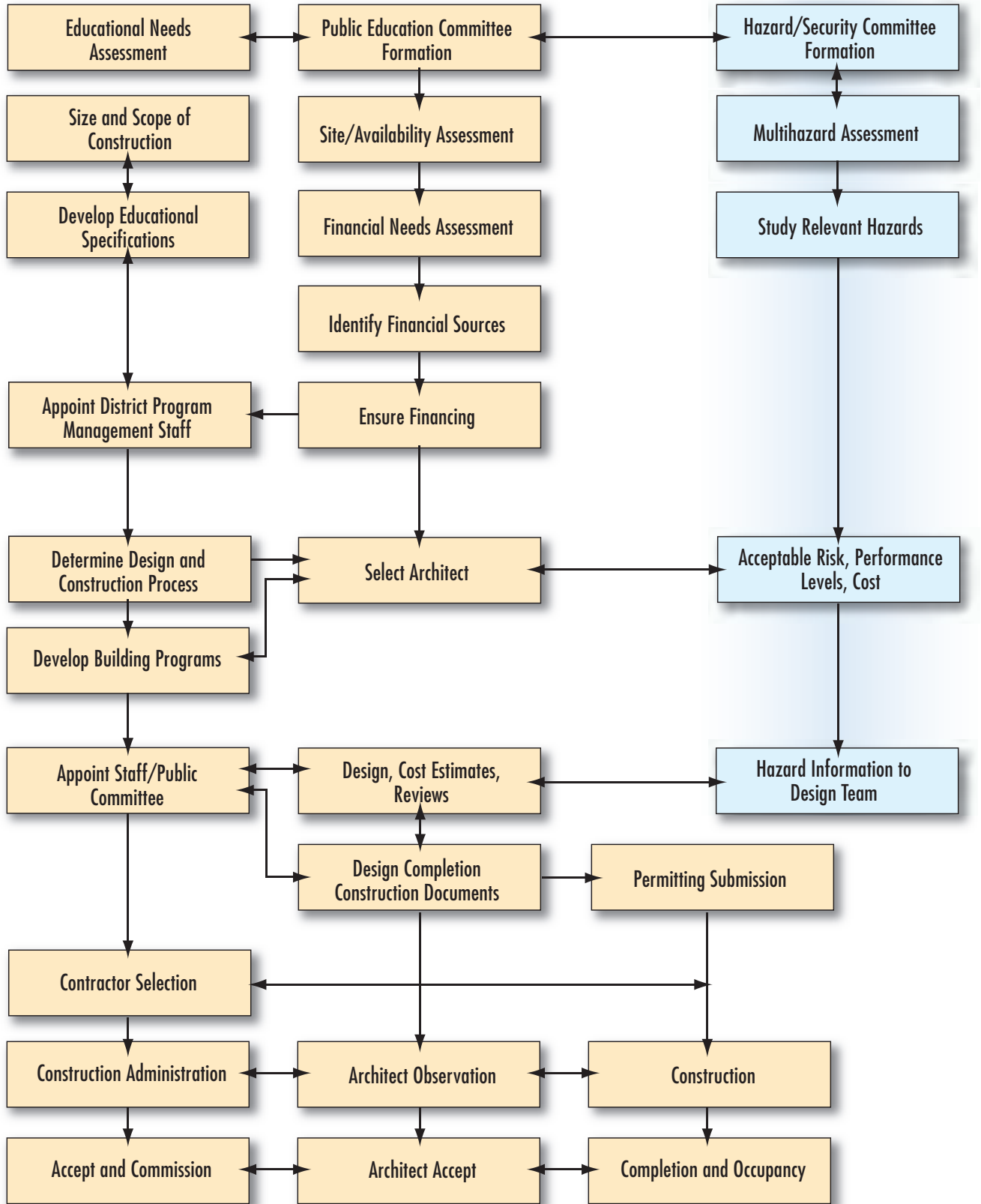

Figure 1-13: Design and construction process flow chart



## 1.7 References

Castaldi, Basil, 1994. *Education Facilities, Planning, Modernization and Management*, Fourth edition, Boston, MA: Allyn & Bacon.

California Building Standards Commission, 2009. 2008 California Green Building Standards Code, Sacramento, CA, January 2009.

National Clearinghouse for Educational Facilities, *U.S. K-12 School Construction Data 1999–2008*, <http://www.ncef.org/cd/School-Construction-Data-1999-2008.pdf>, accessed April 21, 2010, citing McGraw-Hill Construction Data 1998–2008.

U.S. Department of Education, 2009. *The Digest of Education Statistics, 2008*, National Center of Education Statistics, Washington, DC, March 18, 2009.



## Design Guide

for Improving School Safety  
in Earthquakes, Floods, and High Winds

# 2 Performance-Based Design

## 2.1 Background

The model building codes define the minimum design requirements to ensure the safety of occupants during specific design events. Recent natural disasters have prompted recognition that significant damage can occur even when buildings are compliant with the building code. Many critical facilities, including school buildings, are closed after natural disasters, even if damage is relatively minor, suggesting that satisfying the minimum code criteria may not be sufficient to ensure continued functionality. Communities also depend on school buildings to provide reliable shelter and critical services. In order to meet that need, school buildings should be designed and constructed according to criteria that result in continued and uninterrupted functionality.

Building performance is an indicator of how well a structure supports the defined needs of its users. Acceptable performance indicates acceptable (or tolerable) levels of damage or condition that allow

The term “**performance**,” as it relates to exposure to natural hazards, usually refers to a building’s condition after a disaster, i.e., it signifies a level of damage expected or a load that can be resisted.

uninterrupted facility operation. Consequently, performance-based design is the process or methodology used by design professionals to create buildings that protect functionality and the continued availability of services.

The performance-based design approach is not proposed as an immediate substitute for design to traditional codes. Rather, it can be viewed as an opportunity to enhance and tailor the design to match the objectives of the community's stakeholders. For a school project, the stakeholders include everyone who has an interest in the successful completion of a school project (i.e., the school board members, responsible officials, members of the design team, the builders, the community at large, parents, and code enforcement officials). The design team is made up of the architects, engineers, and other design professionals and consultants.

Performance-based codes define acceptable or tolerable levels of risk for a variety of health, safety, and public welfare issues. Currently, codes include the *International Code Council Performance Code for Buildings and Facilities* (ICC PC) produced by the International Code Council (ICC, 2009), and the *NFPA 5000. Building Construction and Safety Code* (NFPA, 2009) and *NFPA 101: Life Safety Code* (NFPA, 2008) produced by the National Fire Protection Association (NFPA). The ICC PC addresses all types of building issues, while the provisions of NFPA 101, "Performance-Based Option," address only issues related to "life safety systems." NFPA 5000 sets forth both performance and prescriptive options for design and construction.

The various prescriptive building, fire, and life safety codes all contain provisions for what is known as "alternative methods and materials" or "equivalency." These provisions allow for the use of methods, equipment, or materials not specified or prescribed in the code, provided the alternative is approved by the code official. A performance-based design approach can be employed under these provisions. While the "alternative methods and materials" clause of the prescriptive codes allows the use of performance-based design procedures, the 2010 edition of the American Society of Civil Engineers (ASCE) Standard 7, *Minimum Design Loads for Buildings and Other Structures*, addresses performance-based design when the standard is used directly, without reference from a building code.

Within ASCE 7-10, "Performance-based Procedures" represent one of three approaches for design. Under the performance-based approach, both structural and nonstructural components and their connections must be shown to provide a reliability not less than that expected under the approach referred to as the "strength procedures." A combination

of testing and analysis can be used to demonstrate the achievement of target reliability that is described in the Commentary that accompanies ASCE 7. Factors that affect target reliability include Risk Category (or Occupancy Category), extent of structural failure, and whether loading conditions include or exclude earthquake.

In 2006, FEMA published FEMA 445, *Next-Generation Performance-Based Seismic Design Guidelines. Program Plan for New and Existing Buildings*. This document includes guidance for developing detailed modeling, simulation of building response to extreme loading, and estimates of potential casualties, loss of occupancy, and economic losses. The outlined process allows the design of a building to be adjusted to balance the level of acceptable risks and the cost of achieving the required level of building performance. Although the process outlined in FEMA 445 is applied to seismic hazards, it can be generalized for application to other hazards.

## 2.2 Prescriptive vs. Performance-Based Design

**D**esign and construction in the United States is generally regulated by building codes and standards. Building codes are intended to ensure the health, safety, and well-being of people in buildings by establishing minimum requirements to address structural strength, adequate means of egress, sanitary equipment, light and ventilation, and fire safety. Building codes may also promote other objectives, such as energy efficiency, serviceability, quality or value, and accessibility for persons with disabilities. These prescriptive standards are easy for architects and engineers to understand, and easy for community inspectors to monitor. This ease of use is their great strength.

Historically, building codes have been based on a prescriptive approach that limits the available solutions for compliance. Prescriptive or specification-based design emphasizes the “input,” or the materials and methods required. In contrast, the focus of performance-based design is the “output,” or the expectations and requirements of the building’s primary users and stakeholders.

This approach provides a systematic method for assessing the performance capabilities of a building, system, or component, which can then be used to verify the equivalent performance of alternatives, deliver standard performance at a reduced cost, or confirm the higher performance needed for critical facilities such as schools.

The ICC PC defines **performance-based design** as “An engineering approach to design elements of a building based on agreed upon performance goals and objectives, engineering analysis and quantitative assessment of alternatives against the design goals and objectives using accepted engineering tools, methodologies and performance criteria.”

## 2.3 The Performance-Based Design Process

The performance-based design process explicitly evaluates how building systems are likely to perform under a variety of conditions associated with potential hazard events. The process takes into consideration the uncertainties inherent in quantifying the frequency and magnitude of potential events and assessing the actual responses of building systems and the potential effects of the performance of these systems on the functionality of buildings. Identifying the performance capability of a facility is an integral part of the design process and guides the many design decisions that must be made. Figure 2-1 presents the key steps in this iterative process.

Performance-based design starts with selecting design criteria articulated through one or more performance objectives. Each performance objective is a statement of the acceptable risk of incurring different levels of damage and the consequential losses that occur as a result of this damage. Losses can be associated with structural or nonstructural damage, and can be expressed in the form of casualties, direct economic costs, and loss of service costs. Loss of service costs may be the most important loss component to consider, especially for critical facilities such as schools.

Figure 2-1:  
Performance-based  
design flow diagram

SOURCE: HAMBURGER, 2003

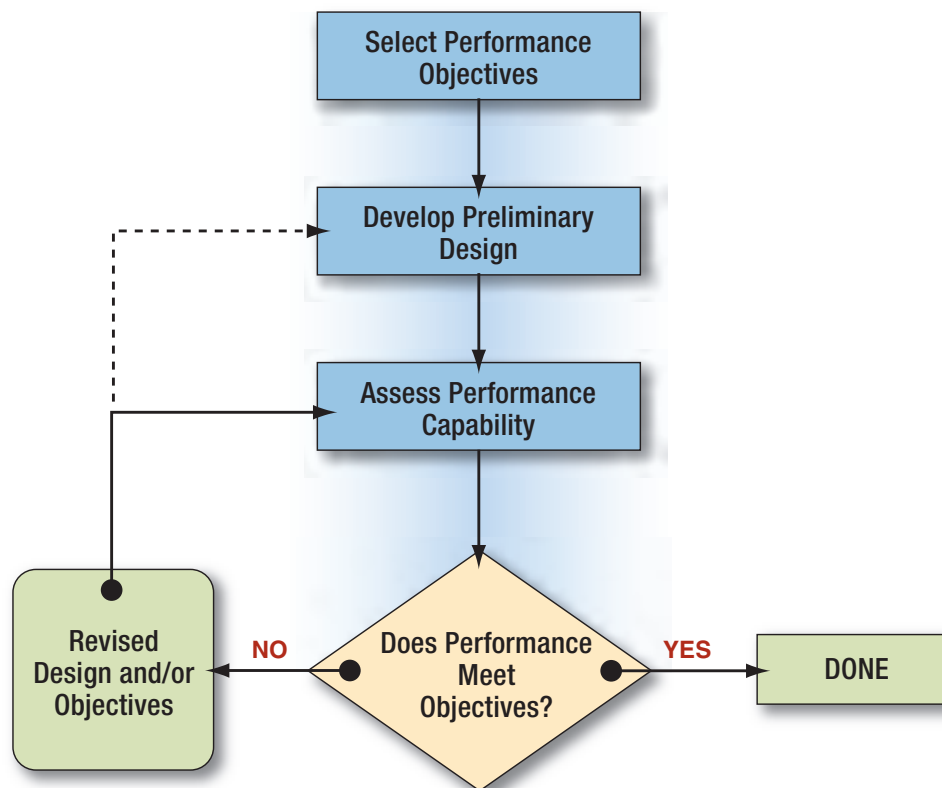

Acceptable risks are typically expressed as acceptable losses for specific levels of hazard intensity and frequency. They take into consideration all the potential hazards that could affect the building and the probability of their occurrence during a specified time period. The overall analysis must consider not only the intensity and frequency of occurrence of hazard events, but also the effectiveness and reliability of the building systems to survive the event without significant interruption in the operation.

**Hazard.** A source of potential danger or adverse conditions. Natural hazards include events such as floods, earthquakes, tornadoes, tsunamis, coastal storms, landslides, and wildfires.

**Risk.** The estimated impact that a hazard event would have on people, services, facilities, and structures in a community, or the likelihood of a hazard event resulting in an adverse condition that causes injury or damage.

## 2.4 Acceptable Risk and Performance Levels

The performance-based design process begins with establishing the acceptable risk and appropriate performance levels for the building and its systems. Acceptable risk is the maximum level of damage to the building that can be tolerated from a realistic risk event scenario or probability. The ICC PC formalizes four performance levels in terms of tolerable levels of damage to the building, its contents, and its occupants that apply to all types of hazards. Types of damage vary according to the hazard. The four performance levels are as follows:

- **Mild Impact.** At the mild impact level, there is no structural damage and the building is safe to occupy. Injuries are minimal in number and minor in nature. Nonstructural systems needed for normal use and emergency operations are fully functional. Damage to contents is minimal in extent and minor in cost. Minimal hazardous materials are released to the environment.
- **Moderate Impact.** At the moderate level, moderate, repairable structural damage, and some delay in re-occupancy is expected. Nonstructural systems needed for building use are fully operational, although some cleanup and repair may be required. Emergency systems remain fully operational. Injuries may be locally significant, but are generally moderate in number and in nature; the likelihood of a single life loss is low and the likelihood of multiple life loss is very low. Some hazardous materials are released to the environment, but the risk to the community is minimal.
- **High Impact.** At the high impact level, significant damage to structural elements, but no large falling debris, is expected. Repair of structural damage is possible, but significant delays in re-occupancy can be expected. Nonstructural systems needed for normal building use are significantly damaged and inoperable. Emergency systems



may be significantly damaged, but remain operational. Injuries to occupants may be locally significant with a high risk to life, but are generally moderate in number and nature. The likelihood of a single life loss is moderate, and the likelihood of multiple life loss is low. Hazardous materials are released to the environment and localized relocation is required.

- **Severe Impact.** At the severe impact level, substantial structural damage is expected and repair may not be technically feasible, though all significant structural components continue to carry gravity load demands. The building is not safe for re-occupancy, because re-occupancy could cause collapse. Nonstructural systems for normal use may be inoperable, and emergency systems may be substantially damaged and inoperable. Injuries to occupants may be high in number and significant in nature. Significant hazards to life may exist. The likelihood of single life loss is high and the likelihood of multiple life loss is moderate. Significant amounts of hazardous materials may be released to the environment and relocation beyond the immediate vicinity is required.

The 2012 edition of the ICC PC will use the same system to classify performance groups that is used in ASCE 7-05 to classify structures. The groups are based on use or occupancy and each has different requirements. Prior to the 2010 edition, the ASCE 7 classification of structures included schools in Occupancy Category III and Occupancy Category IV, based on capacity. ASCE 7-10 categorizes buildings and structures into “risk categories” and no longer includes occupancy type. The risk categories are equivalent to the “performance groups” that are used in the ICC PC. The performance groups that apply to schools include:

- **Performance Group IV** (Risk Category IV) includes buildings and structures designated as essential facilities, and those for which failure could pose a substantial hazard to the community. Essential facilities are defined as those “intended to remain operational in the event of extreme environmental loading from wind, snow, or earthquakes.”
- **Performance Group III** (Risk Category III) includes buildings and structures for which failure could pose a substantial risk to human life and those not included in Risk Category IV with “potential to cause a substantial economic impact and/or mass disruption of day-to-day civilian life in the event of failure.”

The ICC PC relates performance group and the maximum level of damage to be tolerated for different magnitudes of design events, as shown in Figure 2-2. Figure 2-3 relates the magnitude of design event to the mean return period (recurrence interval) for seismic, flood, and wind hazards. For example, consider a Performance Group III building that the stakeholders determine should be designed such that it will have a “moderate” level of performance (or moderate damage is the maximum level of damage to be tolerated). As indicated by Figure 2-2, to provide that level of performance, the building must be designed for large (or rare) events. And, based on Figure 2-3, if it is located in an area exposed to seismic risk, it should be designed for a seismic event that has a 475-year return period. To address flooding, the designers would have to determine the site-specific exposure (i.e., whether the location is exposed to flood hazards in addition to the 1-percent-annual-chance [100-year] flood, such as levee failure or dam failure). And to address high winds, the building should be designed for winds with a 100-year return period.

		INCREASING LEVEL OF PERFORMANCE			
		Performance Groups			
		Performance Group I	Performance Group II	Performance Group III	Performance Group IV
MAGNITUDE OF DESIGN EVENT Increasing Magnitude of Event	Very Large (Very rare)	Severe	Severe	High	Moderate
	Large (Rare)	Severe	High	Moderate	Mild
	Medium (Less Frequent)	High	Moderate	Mild	Mild
	Small (Frequent)	Moderate	Mild	Mild	Mild

Figure 2-2: Maximum level of damage to be tolerated based on performance groups and magnitude of design event

SOURCE: ICC, 2009



Figure 2-3:  
Relative magnitude  
and return period for  
seismic, flood, and wind  
events

SOURCE: ICC, 2009

		DESIGN EVENT		
		Seismic (Mean Return Period)	Flood (Mean Return Period)	Wind (Mean Return Period)
MAGNITUDE OF DESIGN EVENT Increasing Magnitude of Event	Very Large (Very rare)	2,475 Years	Determined on Site-Specific Basis	125 Years
	Large (Rare)	475 Years (Not to Exceed Two-Thirds of the Intensity of Very Large)	Determined on Site-Specific Basis	100 Years
	Medium (Less Frequent)	72 Years	500 Years	75 Years
	Small (Frequent)	25 Years	100 Years	50 Years

## 2.5 Considerations For Achieving Continuous Operation Performance Level

**A**fter the preliminary design has been developed based on the selected performance level, the next step in the performance-based design process is to perform a series of simulations (analyses of building response to loading) to estimate the probable performance of the building under various design scenario events. Using fragility relationships (vulnerability functions defining the relationship between load and damage) developed through testing or calculation, building responses are equated to damage states expressed as levels of performance. If the simulated performance meets or exceeds the performance objectives, the design may be considered complete. If not, the design must be revised in an iterative process until the performance objectives are met. In some cases, meeting the stated objective at a reasonable cost will not be possible, in which case the team of designers, decisionmakers, and stakeholders may elect to modify some of the original performance objectives.

Continued and uninterrupted operation is an important performance requirement for schools, regardless of the level of structural and non-structural building damage, especially schools that are designated as community shelters. In other words, the acceptable performance is achieved as long as the structural and nonstructural damage to the building does not disrupt or impair the continued operation and functionality. In recent hurricanes, structures that did not sustain any

structural damage were rendered inoperable as a result of nonstructural damage resulting in unacceptable performance (FEMA, 2006).

In terms of affecting the functionality and performance of a facility, the failure of nonstructural systems (roofing; exterior envelope; heating, ventilation, and air-conditioning [HVAC]; emergency systems) can be as significant as the failure of structural components. Performance-based design provides a framework for considering the potential hazards that can affect a facility or site, and for explicitly evaluating the performance capability of the facility and its components—including nonstructural systems and components.

Designers must also consider the likelihood that at least a portion of the distribution systems of critical infrastructure services (e.g., electrical power, communications, potable water, and sanitary sewer) could be interrupted. The impact of interruptions in service should be assessed, and the time until service could be restored or supplemented should be estimated. To protect the continued operation of schools, especially those designated as community shelters, the most reliable approach is to provide alternative onsite systems in the form of: (1) emergency power generation capabilities; (2) local wireless communications; (3) potable water supplies; and (4) temporary onsite storage for sanitary waste.

While the practice of performance-based design is more advanced in the field of seismic design than the fields of flood and high-wind design, the theory of performance-based design is transferable to all hazards. The practice of performance-based design will prompt designers and owners of buildings in flood- or high-wind-prone regions to begin thinking in terms of a few basic objectives:

- Can the real probabilities and frequencies of flood and high-wind events during the useful life of the building be defined with an acceptable degree of accuracy?
- Can the extent and kinds of damage that can be tolerated be defined?
- Are there ways in which an acceptable level of performance can be achieved?
- Are there alternative levels of performance that can be achieved, and how much do they cost over the lifetime/ownership of the building compared to the benefits of reduced damage and improved performance?
- How do these levels compare to the performance levels of designs using the minimum requirements of the applicable building code?

## 2.6 Performance-Based Flood Design

The performance levels and objectives for schools and other critical facilities exposed to flood hazards are:

- **Mild Impact.** The facility sustains no structural or nonstructural damage, emergency operations are fully functional, and the building is immediately operational. The site is not affected by erosion, but may have minor debris and sediment deposits.
- **Moderate Impact.** The facility is affected by flooding above the lowest floor, but damage is minimal due to low depths and the short duration of flooding. Cleanup, drying, and minor repairs are required, especially of surface materials and affected equipment, but the building can be back in service in a short period of time.
- **High Impact.** The facility may sustain structural or nonstructural damage that requires repair or partial reconstruction, but the threat to life is minimal and occupant injuries are few and minor. Water damage to the interior of the facility requires cleanup, drying, and repairs, and may preclude occupancy of all or a portion of the facility for several weeks to several months.
- **Severe Impact.** The facility is severely damaged and likely requires demolition or extensive structural repair. Threats to occupants are substantial, and warning plans should prompt evacuation prior to the onset of this level of flooding. This performance level is applicable to facilities affected by all types of flooding, including those that result from failure of dams, levees, or floodwalls.

Planning and design to achieve an appropriate level of flood protection should include avoidance of flood hazard areas and the addition of a factor of safety (freeboard) to the anticipated flood elevation. Performance evaluation of a facility affected by flooding should consider the building response to the following load conditions (fragility functions must be developed to relate calculated response to actual damage states):

- Lateral hydrostatic forces
- Vertical (buoyant) hydrostatic forces
- Hydrodynamic forces
- Surge forces
- Impact forces of floodborne debris
- Breaking wave forces
- Localized scour

## 2.7 Performance-Based High-Wind Design

The performance levels and objectives for schools and other critical facilities exposed to high-wind hazards are:

- **Mild Impact.** The facility is essentially undamaged and is immediately operational.
- **Moderate Impact.** The facility is damaged and needs some repairs but can be functional and occupied after minor repairs to nonstructural components are complete.
- **High Impact.** The facility may be structurally damaged but the threat to life is minimal and occupant injuries are few and minor. However, damage to nonstructural components (e.g., roofing, building envelope, exterior-mounted equipment) is great, and the cost to repair the damage is significant. If rain accompanies the windstorm, or if rain occurs prior to execution of emergency repairs, water damage to the interior of the facility may preclude occupancy of all or a portion of the facility for several weeks to several months.
- **Severe Impact.** The facility is severely damaged and will probably need to be demolished. Significant collapse may have occurred, and there is a great likelihood of occupant casualties unless the facility has a specially designed occupant shelter. This performance level is applicable to facilities struck by strong or violent hurricanes or tornadoes. For other types of windstorms, this performance level should not be reached.

The challenge with respect to performance-based high-wind design is assessing the wind resistance of the building envelope and exterior-mounted equipment, and the corresponding damage susceptibility. Several factors make this assessment challenging:

- Analytical tools (i.e., calculations) are currently not available for many envelope systems and components, and realistic long-term wind resistance data is lacking.
- Because of the complexity of their wind load responses, many envelope systems and components require laboratory testing, rather than analytical evaluation, in order to determine their load-carrying capacities.
- Eventually, finite element analysis will likely augment or replace laboratory testing, but substantial research is needed before finite element analysis can be used for the broad range of existing building envelope systems.
- Significant research is needed before design professionals can accurately assess the response of buildings and components to the effects of high winds.

## 2.8 Performance-Based Seismic Design

For performance-based seismic design, the performance levels described in ASCE 41, *Seismic Rehabilitation of Existing Buildings* (2007), for both structural and nonstructural systems are the most widely-recognized characterizations. These performance levels are summarized in a matrix (see Table 2-1) and allow specification of an overall performance level by combining the desired structural performance with a desired nonstructural performance.

Table 2-1: Combinations of structural and nonstructural seismic performance

Nonstructural Performance Levels	Structural Performance Levels and Ranges					
	S-1 Immediate Occupancy	S-2 Damage Control Range	S-3 Life Safety	S-4 Limited Safety Range	S-5 Collapse Prevention	S-6 Not Considered
N-A Operational	Operational 1-A	2-A	Not Recommended	Not Recommended	Not Recommended	Not Recommended
N-B Immediate Occupancy	Immediate Occupancy 1-B	2-B	3-B	Not Recommended	Not Recommended	Not Recommended
N-C Life Safety	1-C	2-C	Life Safety 3-C	4-C	5-C	6-C
N-D Hazards Reduced	Not Recommended	2-D	3-D	4-D	5-D	6-D
N-E Not Considered	Not Recommended	Not Recommended	Not Recommended	4-E	Collapse Prevention 5-E	No Rehabilitation

Four of the ASCE 41 performance levels identified in Table 2-1 are analogous to the ICC PC performance levels. “Mild” is similar to Operational (1-A); “Moderate” is similar to Intermediate Occupancy (1-B); “High Impact” is similar to Life Safety (3-C); and “Severe” is similar to Collapse Prevention (5-C). These four performance levels are described below.

### Operational Building Performance Level (1-A)

Buildings that meet this building performance level are expected to sustain minimal or no damage to their structural and nonstructural components. The building is able to continue its normal operations with only slight adjustments for power, water, or other utilities that may need to be provided from emergency sources.

Under low levels of earthquake ground motion, most schools should be able to meet or exceed this target building performance level. However, designing buildings to achieve this performance level under very rare, intense ground shaking, may not be cost effective except for buildings that offer unique services or that contain exceptionally hazardous material.

Full functionality is normally considered difficult to achieve in the immediate aftermath of strong earthquake shaking. Offsite issues, such as staff availability and potential loss of utilities that are not under the control of the facility, may more seriously impair operations. In addition, relatively minor onsite damage to key components can significantly affect overall functionality. For example, failure of a single anchor point for a primary emergency generator could disrupt functionality at least for a short period of time.

### **Immediate Occupancy Building Performance Level (1-B)**

Buildings that meet this building performance level are expected to sustain minimal damage to their structural elements and only minor damage to their nonstructural components. While it is safe to reoccupy a building designed for this performance level immediately following a major earthquake, nonstructural systems may not function due to power outage or damage to fragile equipment. Consequently, although immediate occupancy is possible, some cleanup and repair and restoration of utility services may be necessary before the building can function in a normal mode. The risk of casualties at this target performance level is very low.

Many building owners may wish to achieve this level of performance when the building is subjected to moderate earthquake ground motion. In addition, some owners may desire such performance for very important buildings even if exposed to severe earthquake ground shaking. This level provides most of the protection obtained under the Operational Building Performance Level without the costs of standby utilities and rigorous seismic equipment performance.

Designing to the Immediate Occupancy Building Performance Level is more realistic than the Operational Building Performance Level for most buildings, and at a minimum, should be the design goal for all new school buildings. However, because even the smallest disruption of nonstructural systems may be too detrimental for continued operation of a school that is designated as a shelter, owners and designers should consider an even higher level of protection for critical functions associated with this use. For instance, stakeholders should consider providing for the independent operation of critical utilities

for a minimum of 4 days. Critical utilities usually include electric power, water, sanitary sewer, and, depending on the local weather conditions, fuel for heating and cooling.

### **Life Safety Building Performance Level (3-C)**

Buildings that meet this building performance level may experience extensive damage to structural and nonstructural components. Repairs may be required before re-occupancy, though in some cases extensive restoration or reconstruction may not be cost effective. The risk of casualties at this target performance level is low.

This building performance level allows somewhat more extensive damage than would be anticipated for new buildings designed and constructed for seismic resistance. The Life Safety Building Performance Level should prevent significant casualties among able-bodied school occupants.

### **Collapse Prevention Building Performance Level (5-E)**

Although buildings that meet this building performance level may pose a significant hazard to life safety resulting from failure of nonstructural components, significant loss of life may be avoided by preventing collapse of the entire building. However, many buildings designed to meet this performance level may be complete economic losses.

Sometimes this performance level is selected as the basis for mandatory seismic rehabilitation ordinances enacted by regulatory authorities because it mitigates the most severe life-safety hazards at the lowest cost. The Collapse Prevention Building Performance Level is intended to prevent only the most egregious structural failures, and does not allow for continued occupancy and functionality or cost-effective damage repair of structural and nonstructural components.

## **2.9 References**

American Society of Civil Engineers (ASCE), 2005. *Minimum Design Loads for Buildings and Other Structures*, ASCE 7-05, Structural Engineering Institute, Reston, VA.

ASCE, 2007. *Seismic Rehabilitation of Existing Buildings*, ASCE 41-06, Structural Engineering Institute, Reston, VA.

ASCE, 2010. *Minimum Design Loads for Buildings and Other Structures*, ASCE 7-10, Structural Engineering Institute, Reston, VA.



Federal Emergency Management Agency (FEMA), 2006. *Hurricane Katrina in the Gulf Coast: Mitigation Assessment Team Report, Building Performance Observations, Recommendations, and Technical Guidance*, FEMA 549, Washington, DC, July 2006.

Hamburger, R.O., 2003. “A Vision for Performance Based Earthquake Engineering,” Unpublished white paper for the ATC-58 Project, Framework for Performance-Based Design of Nonstructural Components, Applied Technology Council, Redwood City, CA, 2003.

International Code Council, Inc. (ICC), 2009. *ICC Performance Code for Buildings and Facilities (ICC PC)*, Country Club Hills, IL, 2009.

National Fire Protection Association (NFPA), 2008. *NFPA 101: Life Safety Code*, 2009 Edition, Quincy, MA, 2008.

NFPA, 2009. *Building Construction and Safety Code*, NFPA 5000, Quincy, MA, 2009.





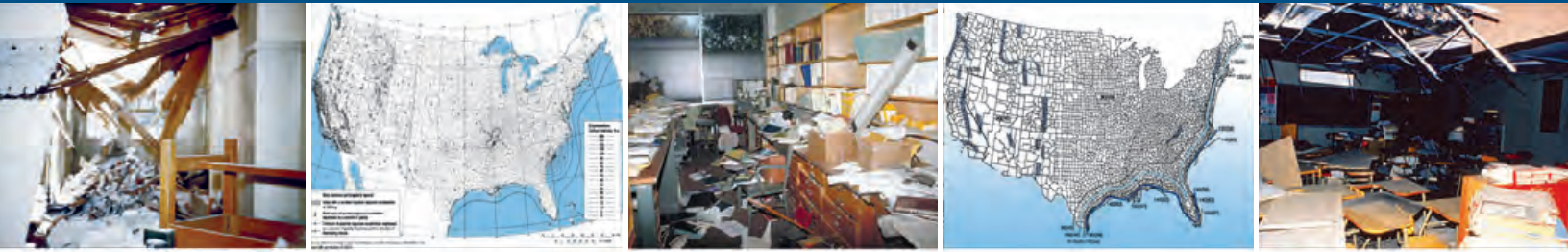

## Design Guide

for Improving School Safety  
in Earthquakes, Floods, and High Winds

# 3 Multihazard Design

### 3.1 Introduction

**T**his chapter compares the effects of three natural hazards that are the subject of this publication, in terms of their geographical locations, relative warning times, and how likely they are to occur. Fire and life safety considerations are discussed. The design methods used to resist the effects of each natural hazard are discussed in the context of the design methods for the other natural hazards. This integrated approach is a key aspect of multihazard design that must be reflected in a larger integrated approach to the whole building design.

### 3.2 The Hazards Compared

**T**his section compares the three natural hazards together with issues relating to designing for fire protection, which is required for all school buildings. A general understanding of all hazards is necessary in order to develop an integrated approach which is important for locations subject to more than one hazard. Designs for two or more hazards may reinforce one another, thus reducing cost and improving

protection. They may also conflict with each other. This section presents a systematic analysis of these multihazard protection methods. The analysis takes the form of the matrices shown in Section 3.5. Facility planners and designers faced with the challenge of multihazard design requirements may find this section beneficial to stimulate discussion and to prompt analysis at the outset of project design. The threat of physical attack is covered in a companion publication, FEMA 428, *Primer to Design Safe School Projects in Case of Terrorist Attacks*.

### 3.2.1 Location: Where do Hazards Occur?

The common public perception of natural hazards is that earthquakes occur in California, floods involve major rivers, tornadoes strike the Midwest, and hurricanes affect the shorelines of the southern Atlantic and Gulf of Mexico. Although there is some truth to this perception as it relates to the highest probabilities, maps that show past disasters reveal that the entire United States is vulnerable to one or more of the three primary natural hazards: earthquakes, floods, or high winds.

- Earthquakes are predominant in the West, but also threaten specific regions in the Midwest, Northeast, and Southeast, and the U.S. territories.<sup>1</sup> The great earthquakes centered on the little town of New Madrid, MO, in 1811 and 1812 caused little damage and only a few casualties; a recurrence of these earthquakes would impact some of the most populous cities of the Midwest. The worst earthquake in the eastern States occurred in Charleston, SC, in 1886; 60 people were killed and the modest sized city suffered the equivalent of about \$25 million damage in today's dollars.
- Riverine floods occur along rivers and streams of all sizes, and coastal flooding is associated with storm surges caused by high winds along the entire U.S. shoreline and Great Lakes. Flash floods caused by sudden, intense rainstorms may occur anywhere. Some of the worst floods in U.S. history have been caused by dam failures, often when rivers are already swollen by flood waters.
- Extreme winds are regional (e.g., hurricanes along the Atlantic and Gulf coasts, the Caribbean, and the South Pacific; tornadoes typically in the Midwest; and downslope winds adjoining mountain ranges), but high winds can also occur anywhere.
- Alaska, Hawaii, parts of the East Coast, and the U.S. territories may all be affected by earthquakes, floods, and high winds.

---

<sup>1</sup> The U.S. territories include American Samoa, Guam, Northern Mariana Islands, Puerto Rico, and the U.S. Virgin Islands.

Figure 3-1 illustrates the areas where earthquakes are likely to occur on the U.S. mainland. The contour lines indicate the 2-percent probability of exceedance of ground motion accelerations within each contour area (or the “odds” [2 percent] that the accelerations will be exceeded in a 50-year period). Figure 3-2 is the basic wind speed map from ASCE 7 that is cited in the model building codes and used to select design wind speeds. In addition to high wind regions around the Gulf and Atlantic Coasts, it identifies “special wind regions” in mountainous areas where high winds are likely. Locations where flooding is likely cannot be illustrated in a similar manner because flooding occurs along virtually every body of water, whether large or small. Flood hazard maps are available at the county and municipality level. Chapters 4, 5, and 6 provide information that will help establish the risk for each of these hazards (earthquakes, floods, and high winds) in a local region, respectively.

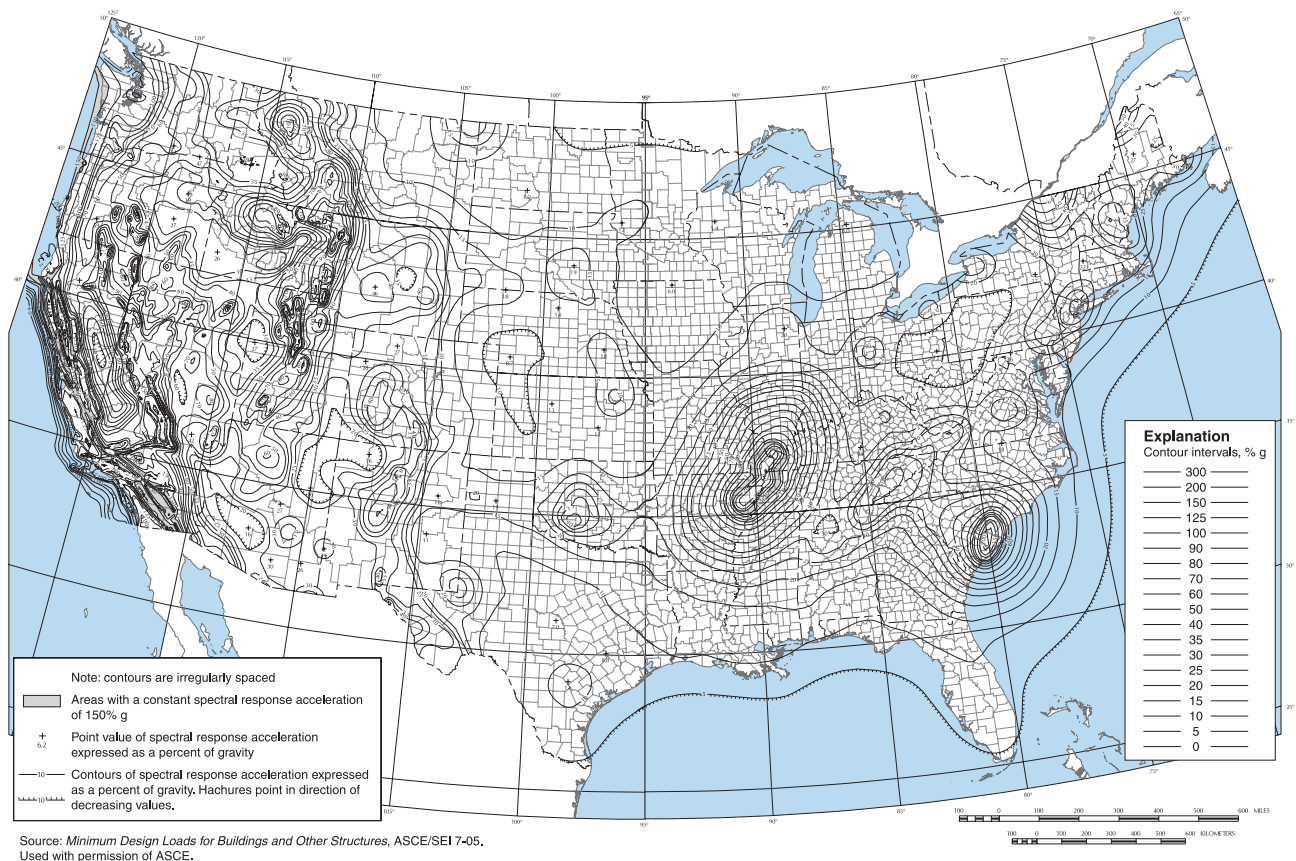

**Figure 3-1:** Areas where earthquakes are likely to occur on the U.S. mainland. The contour lines indicate the 2-percent probability of exceedance of ground motion accelerations within each contour area (or the “odds” [2-percent] that the accelerations will be exceeded in a 50-year period).



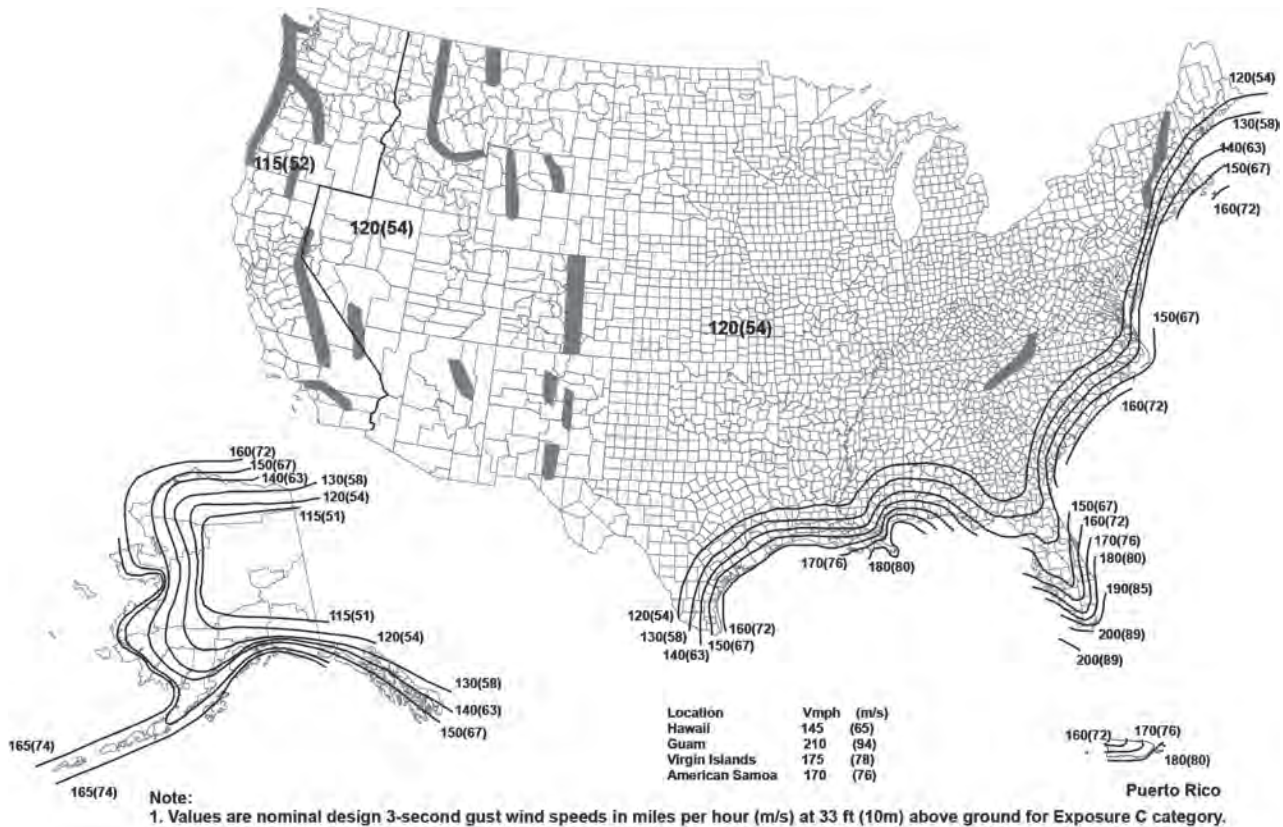

Figure 3-2:

Basic wind speed map from ASCE 7 for Risk Category III and IV buildings and other structures. ASCE 7 is cited in the model building codes and used to select design wind speeds.

SOURCE: ASCE 7-10

### 3.2.2 Warning: How Much Warning is There?

The warning times for the three primary natural hazards vary as a function of many variables:

- Earthquakes are unique among the natural hazards because there is no warning at all, although new sensing devices can give a few seconds warning to locations far from the epicenter. Although much work has been done throughout the world to develop a scientific prediction methodology (based on characteristics such as changes in the dimensional or physical nature of the ground prior to an earthquake, detailed investigation of the geologic strata, or statistical data on the incidence of previous earthquakes), earthquakes must still be regarded as random events within a general envelope of probability.
- Riverine floods (except flash floods) can usually be predicted to give hours or days of warning. National and regional river monitoring

systems and numerous local weather and flood warning systems provide improved warning along many waterways.

- Coastal flooding associated with hurricanes can be anticipated because tropical systems can be tracked for days before making landfall. Hurricanes are tracked by the National Hurricane Center and their movements are carefully and thoroughly reported although there are many variables that limit the precision of predictions. Other coastal storms, such as nor'easters and those that affect the Pacific and Great Lakes shorelines are less predictable.
- Tornadoes are localized, though sometimes visible from a distance. However, modern technology allows the National Weather Service to identify conditions that are conducive to the formation of tornadoes. Typically, they hit a specific location with only a few minutes notice.

### 3.2.3 Frequency: How Likely are They to Occur?

For all hazards, the probability that an event will occur within a region is much higher than the probability that an event will occur at a specific location. Extreme events are relatively rare for a given site. Some level of inundation in riverine floodplains and coastal shorelines occurs relatively frequently. Storms that produce sufficient rainfall-runoff to cause river and stream flooding can occur throughout the year, although are more prevalent during specific seasons in some areas of the country. Coastal nor'easter storms generally occur in the winter and early spring months, while hurricanes roam the Gulf Coast and Atlantic seaboard between June 1st and the end of November, bringing both high winds and storm surge flooding.

Earthquakes are perhaps the most difficult to deal with, because of their complete lack of warning, their rarity, and their possible extreme consequences. Although an earthquake of a given magnitude is still, in practical terms, unpredictable, its probability of occurrence can reasonably be predicted as far higher in California or Alaska than in, for example, Massachusetts or Tennessee. Even in California, the rarity of a large earthquake is such that many people will not experience one in their lifetime. In less seismically active parts of the country, the probability of an event is even smaller.

Because the occurrence of natural hazards is only broadly predictable, the frequency of occurrence of future events can only be expressed as probabilities. The probability of occurrence of earthquakes, floods, and high winds is commonly expressed by the term “return period” or “mean recurrence interval,” which is defined as the average or mean time in years between the expected occurrence of events of specified intensity.

Prior to the 2000 *International Building Code (IBC)*, the seismic maps in the model buildings codes used a level of shaking (an acceleration value) that corresponds to a 10-percent probability of exceedance in 50 years (or a probability that it would be exceeded one time in approximately 475 years, a 475-year recurrence interval). More recently, research suggests that certain areas, such as the central and eastern United States and in particular the New Madrid Seismic Zone, may be vulnerable to much larger but less frequent quakes. More recent seismic hazard maps produced by the U.S. Geological Survey (USGS) and appearing in the 2000 IBC and later editions show acceleration values for a 2-percent probability of exceedance in 50 years (e.g., a recurrence interval of 2,475 years). Designs based on this level are expected to provide significant protection in areas subject to large but less frequent earthquakes. Additional information about seismic maps appearing in the IBC can be found in FEMA 450, *NEHRP Recommended Provisions for Seismic Regulations for New Buildings and Other Structures* (2003a).

Beginning with the 2010 edition of ASCE 7, for Risk Category III and IV buildings, the basic wind speed is associated with a return period of 1,700 years, or an annual exceedance probability of 0.000588. The magnitude of flood event used as the minimum design value is the 1-percent-annual-chance flood, which has a 100-year return period (often call the “100-year flood”). These return periods may seem very long (i.e., a business owner confronting small crises every day and large ones every month may not be worried about an event that might not occur for 500 years). And if the return period for an earthquake event in California is 500 years, the public may erroneously believe that it will be another 400 years before an event of the magnitude of the 1906 San Francisco earthquake occurs.

These expressions of frequency represent mean or average return periods over a very long period of time, but may be perceived as not pertinent in relation to the shorter time periods that most people are interested in (i.e., the next year or the next 10 years). Because floods and high winds occur relatively more frequently, the discrepancy between the actual occurrence experienced at a given location and the mean return period used to establish design loads is much more noticeable than the corresponding probabilities for earthquakes.

### 3.3 A Comparison of Potential Losses

**T**he HAZUS-MH (Hazards U.S. Multi-Hazards) program is a Geographic Information System (GIS)-based program developed by FEMA to estimate future losses for use by Federal, State, regional, and local governments to plan for damage, to prepare emergency response and recovery programs, and to help examine options to reduce



future damage. The methodology covers nearly all aspects of the built environment and estimates a wide range of losses. Originally developed to assess risks from earthquakes, the methodology has been expanded to address floods throughout the United States and hurricanes in the Atlantic and Gulf Coast regions.

In order to obtain an indication of the magnitude of losses and their relative significance for the three hazards considered in this design guide, a “Level 1” HAZUS-MH analysis was conducted in 2003 for educational facilities in six areas of the United States. The Level 1 analysis uses the building inventory data that are packaged with the HAZUS-MH program and is intended to give a broad picture of damage and loss on a regional basis. Although prepared several years ago, the results remain useful to compare potential losses between different parts of the country.

The analyses were based on the building information for the EDU 1 occupancy class (the HAZUS-MH designation for the school building inventory) in the general building stock module of HAZUS-MH. The regions chosen for this comparative example are each prone to two or more of the hazards addressed in HAZUS-MH, and are deemed to provide a useful geographic range. For each region and applicable hazard, probabilistic losses for a 100- and 500-year return period event (earthquake, flood, or high wind) were computed. The results are summarized in Table 3-1, in which the column “EDU 1 Exposure” refers to the total school inventory in each region.

The following regions were evaluated:

- Charleston County, SC (Charleston) (earthquake, flood, and hurricane)
- Shelby County, TN (Memphis) (earthquake and flood)
- Bexar County, TX (San Antonio) (hurricane and flood)
- Salt Lake County, UT (Salt Lake City) (earthquake and flood)
- Suffolk County, MA (Boston) (earthquake, flood, and hurricane)
- Hillsborough County, FL (Tampa) (hurricane and flood)

Table 3-2 shows the estimated losses expressed as a percentage of the total school inventory. It is instructive to note, in some cases, the wide disparity in losses between the 100-year and 500-year events, which supports the idea that school facilities should be designed to resist the impacts of events that have a lower probability of occurrence.

Table 3-1: HAZUS-MH earthquake, hurricane, and flood losses (all values are in \$1,000s—2002 valuation)

Charleston, SC	Earthquake		Hurricane		Flood		EDU 1 Exposure
	100-yr	500-yr	100-yr	500-yr	100-yr	500-yr	
Building Damage	31	3,449	5,802	22,290	1,378	1,554	63,787 Building
Contents and Inventory	4	1,365	3,690	16,897	392	557	63,787 Contents
Business Interruption	5	320	2,052	6,558	NE	NE	
<b>TOTAL</b>	<b>40</b>	<b>5,134</b>	<b>11,544</b>	<b>45,745</b>	<b>1,770</b>	<b>2,111</b>	
Shelby, TN	Earthquake		Hurricane		Flood		EDU 1 Exposure
	100-yr	500-yr	100-yr	500-yr	100-yr	500-yr	
Building Damage	243	10,464	N/A	N/A	4,184	6,784	137,927 Building
Contents and Inventory	53	3,723	N/A	N/A	1,203	2,001	137,927 Contents
Business Interruption	29	916	N/A	N/A	NE	NE	
<b>TOTAL</b>	<b>325</b>	<b>15,103</b>	<b>–</b>	<b>–</b>	<b>5,387</b>	<b>8,786</b>	
Bexar, TX	Earthquake		Hurricane		Flood		EDU 1 Exposure
	100-yr	500-yr	100-yr	500-yr	100-yr	500-yr	
Building Damage	N/A	N/A	94	2,753	1,502	2,384	238,608 Building
Contents and Inventory	N/A	N/A	5	1,259	487	727	238,608 Contents
Business Interruption	N/A	N/A	7	2,078	NE	NE	
<b>TOTAL</b>	<b>–</b>	<b>–</b>	<b>106</b>	<b>6,090</b>	<b>1,989</b>	<b>3,111</b>	
Salt Lake, UT	Earthquake		Hurricane		Flood		EDU 1 Exposure
	100-yr	500-yr	100-yr	500-yr	100-yr	500-yr	
Building Damage	2,175	30,313	N/A	N/A	15	204	177,728 Building
Contents and Inventory	881	9,016	N/A	N/A	4	57	177,728 Contents
Business Interruption	259	2,488	N/A	N/A	NE	NE	
<b>TOTAL</b>	<b>3,315</b>	<b>41,817</b>	<b>–</b>	<b>–</b>	<b>19</b>	<b>261</b>	
Suffolk, MA	Earthquake		Hurricane		Flood		EDU 1 Exposure
	100-yr	500-yr	100-yr	500-yr	100-yr	500-yr	
Building Damage	0	1,544	4,837	58,640	254	907	268,311 Building
Contents and Inventory	0	484	2,258	40,665	70	305	268,311 Contents
Business Interruption	0	172	2,871	18,316	NE	NE	
<b>TOTAL</b>	<b>0</b>	<b>2,200</b>	<b>9,966</b>	<b>117,621</b>	<b>324</b>	<b>1,212</b>	
Hillsborough, FL	Earthquake		Hurricane		Flood		EDU 1 Exposure
	100-yr	500-yr	100-yr	500-yr	100-yr	500-yr	
Building Damage	N/A	N/A	10,257	47,213	10,727	11,776	175,981 Building
Contents and Inventory	N/A	N/A	6,045	39,016	4,329	4,624	175,981 Contents
Business Interruption	N/A	N/A	4,291	13,004	NE	NE	
<b>TOTAL</b>	<b>–</b>	<b>–</b>	<b>20,593</b>	<b>99,233</b>	<b>15,056</b>	<b>16,400</b>	

NOTES: EDU 1 Exposure = total school and contents inventory in each region (2003).

NE = HAZUS did not estimate these losses.

0 = Evaluated, but no losses.

N/A = hazard not present in the area.

Table 3-2: HAZUS-MH estimated losses by percentage of school building and contents inventory

County	Earthquake		Hurricane		Flood	
	100-yr	500-yr	100-yr	500-yr	100-yr	500-yr
Charleston, SC	0.20	17.30	4.54	17.50	1.38	1.65
Shelby, TN	0.12	5.47	N/A	N/A	1.95	2.46
Bexar, TX	N/A	N/A	0.02	1.27	0.40	0.65
Salt Lake, UT	1.10	11.76	N/A	N/A	0.01	0.07
Suffolk, MA	0	0.80	N/A	N/A	N/A	N/A
Hillsborough, FL	N/A	N/A	5.85	28.20	4.27	4.65

NOTES: N/A = hazard not present in the area.

These HAZUS-MH results, though prepared in 2003, limited in scope, and based on limited school building inventory information, provide some interesting comparisons:

- Generally, the 100-year earthquake causes insignificant damage, except in Salt Lake City, UT (\$3.3 million).
- The 500-year earthquake causes the most damage in Salt Lake City, UT (\$41.8 million), followed by Shelby, TN (\$15.1 million), and Charleston, SC (\$5.1 million).
- The 100-year hurricane causes the most damage in Hillsborough, FL (\$20.6 million), followed by Charleston, SC (\$11.5 million), and Suffolk, MA (\$10 million).
- The 500-year hurricane causes \$117.6 million in damage in Suffolk, MA, \$99.2 million in damage in Hillsborough, FL, and \$45.7 million in damage in Charleston, SC.
- The 100-year flood causes by far the most damage in Hillsborough, FL (\$15.1 million; however, the 500-year flood causes only another \$1.3 million in damage). In Shelby, TN, the 100-year flood causes \$5.4 million in damage and the 500-year flood causes another \$3.3 million.
- Charleston, SC, has the greatest combined threat from earthquakes and hurricanes; Hillsborough, FL, has the greatest combined threat from hurricanes and floods.

### 3.4 Fire and Life Safety

**O**f the many hazards that can endanger a school, its occupants, and its service to the community, the most prevalent is fire. Structure fires occur more frequently than any of the hazards noted above. However, requirements to account for fire protection and safety have long been included in building codes in the form of requirements for approved materials, fire-resistant assemblies, exiting, the width and design of stairs, the dimensions of corridors, fire suppression systems, and many other issues. In fact, fire considerations are now so embedded in the design culture and regulation that some designers may not fully consider the fire hazard as a specific design issue.

Of the many hazards that can endanger a school, its occupants, and its service to the community, the most prevalent is fire. Structure fires occur more frequently than any of the hazards noted above.

Fires in older school buildings often result in a total loss of the building. This is due to a variety of factors, which include: delay of discovery and alarm, remote locations, lack of fire walls and/or compartmentation, lack of draft stopping in combustible attics, lack of automatic fire sprinkler systems, and inadequate water supplies for manual fire suppression activities. Losses in buildings without automatic fire alarm and detection systems are twice those in buildings with such systems. Additionally, fire losses in buildings without automatic fire sprinkler protection are five times higher than those in buildings protected by sprinklers.

Since the 1970s, the provisions of the various building codes have continued to improve the level of fire and life safety of new school facilities. The code requirements do not apply to existing buildings until renovations or additions are made, and then the requirements may apply only to the new work. Given that the average age of school facilities in the United States is more than 40 years, older buildings likely do not provide the same level of protection as newer buildings. In order to provide the level of protection achieved in newer buildings, the levels of fire and life safety of older facilities should be evaluated. After an evaluation has been conducted, solutions using prescriptive and/or performance approaches can be developed and undertaken.

The existing structures chapter of the IBC provides a method to evaluate the overall level of fire and life safety in an existing building. Although the method is generally intended to be applied to an existing building during changes in occupancy or renovation, it can provide the basis for the evaluation of any existing building.

The evaluation method comprises three categories: fire safety, means of egress, and general safety. The fire safety evaluation includes structural

fire resistance, automatic fire detection, and fire alarm and fire suppression systems. Included within the means of egress portion are the configuration, characteristics, and support features for the means of egress. The general safety section evaluates various fire safety and means of egress parameters. The evaluation method generates a numerical score in the various areas, which can then be compared to mandatory safety scores. Deficiencies in one area may be offset by other safety features.

The provisions of NFPA 101 provide another method of evaluating and upgrading existing facilities. This document is intended to be applied retroactively to existing facilities and has a chapter specifically for existing educational occupancies. Even if this code is not adopted by the local jurisdiction, it can be used as the basis for an evaluation of any existing facility.

Upgrading an existing school facility can be costly. However, the cost of upgrades generally is less than the direct and indirect losses if a facility sustains major damage caused by fire. The most effective method of providing fire protection is through automatic fire sprinklers, but other lower cost methods can be utilized, including:

- Automatic fire alarm and detection
- Draft stopping in combustible attic spaces
- Smoke and fire compartmentation walls in occupied spaces

Upgrades in fire and life safety can often be coordinated with other building renovations or upgrades to help reduce costs. For instance, draft stopping could be installed in a wood framed attic during roof deck replacement. Fire sprinklers could be installed during asbestos abatement or ceiling replacement/upgrades for seismic concerns.

### 3.5 Multihazard Design Interactions

**A**n integrated approach to designing for all hazards can help to identify potentially conflicting effects of certain mitigation measures and help to avoid aggravating the vulnerability of school systems and components. Table 3-3 summarizes the effects that design for more than one hazard may have on the performance of the building, addition, or repair. The columns show the five primary hazards. The rows show examples of methods of protection that have significant interaction (either beneficial, undesirable, or little to no significance). These methods are taken from the extended descriptions of risk reduction methods for the three primary natural hazards (see Chapters 4, 5,

and 6), together with the methods for security/blast protection presented in FEMA 428. In addition, the interactions of these four categories of risk protection with fire safety, where they occur, are also suggested.

The suggested interactions are intended to provoke thought and design integration; they are not absolute restrictions nor are they recommendations. In general, beneficial conditions can be identified and undesirable conditions and conflicts can be avoided through coordinated design between the consultants, starting at the inception of design. The table can be used as a starting point for discussion relative to specific projects and to structure the benefits and conflicts of multihazard design depending on local hazards.

**Table 3-3: Multihazard design system interactions**

Key	
✓	Indicates desirable condition or method for designated component/system
✗	Indicates undesirable condition or method for designated component/system
○	Indicates little or no significance for designated component/system
	Split box indicates significance may vary, see discussion issues

Building System Protection Methods: Reinforcements and Conflicts							
System ID	Existing Conditions or Proposed Protection Methods	The Hazards					Discussion Issues
		Earthquake	Flood	Wind	Security/Blast	Fire	
1	Site						
1-1	Building elevated on fill	○	✓	○	○	○	Excellent solution for flood.
1-2	Two means of site access	✓	✓	✓	✓	✓	
1-3	In close proximity to other facilities that are high risk targets for attack	○	○	○	✗	○	

Table 3-3: Multihazard design system interactions

Building System Protection Methods: Reinforcements and Conflicts								
System ID	Existing Conditions or Proposed Protection Methods	The Hazards					Discussion Issues	
		Earthquake	Flood	Wind	Security/Blast	Fire		
2	Architectural							
2A	Configuration							
2A-1	Large roof overhangs	X	○	X	X	○	Possibly vulnerable to vertical forces in earthquake, uplift wind forces. The wall to roof intersection will tend to contain and concentrate blast forces if the point of detonation is below the eaves.	
2A-2	Re-entrant corner (L-, U-shape, etc.) building forms	X	○	X	X	○	May concentrate wind or blast forces; may cause stress concentrations and torsion in earthquakes.	
2A-3	Enclosed courtyard building forms	X	○	✓	✓	X	○	May cause stress concentrations and torsion in earthquake; courtyard provides protected area against high winds. Depending on individual design, they may offer protection or be undesirable during a blast event. If they are not enclosed on all four sides, the “U” shape or re-entrant corners create blast vulnerability. If enclosed on all sides, they might experience significant blast pressures, depending on building and roof design. Because most courtyards have significant glazed areas, this could be problematic.
2A-4	Very complex building forms	X	X	X	X	X	May cause stress concentrations and torsion in highly stressed structures, and confusing evacuation paths and access for firefighting. Complicates flood resistance by means other than fill.	
2B	Planning and Function (No significant impact)							
2C	Ceilings (No significant impact)							



Table 3-3: Multihazard design system interactions

Building System Protection Methods: Reinforcements and Conflicts								
System ID	Existing Conditions or Proposed Protection Methods	The Hazards					Discussion Issues	
		Earthquake	Flood	Wind	Security/Blast	Fire		
2	Architectural (continued)							
2D	Partitions							
2D-1	Block, hollow clay tile partitions	X	✓	X	X	✓	Wind and seismic force reactions would be similar for heavy unreinforced wall sections, with risk of overturning. Tile may become flying debris during a blast. It is possible, but difficult, to protect structures with blast walls, but a weak nonstructural wall has more chance of hurting people as debris. Desirable against fire and not seriously damaged by flood.	
2D-2	Use of non-rigid connections for attaching interior non-load bearing walls to structure	✓	○	✓	✓	X	Non-rigid connections are necessary to avoid partitions influencing structural response. However, gaps provided for this threaten the fire resistance integrity and special detailing is necessary to close gaps but retain ability for independent movement.	
2D-3	Gypsum board partitions	✓	X	○	X	X	Although gypsum board partitions can be constructed to have a fire resistance rating, they can be easily damaged during fire operations. Such partitions can be more easily damaged or penetrated during normal building use.	
2D-4	Concrete masonry units (CMUs), hollow clay tile around exit ways and exit stairs	X	○	○	X	✓	✓	May create torsional structural response and/or stress concentration in earthquakes in frame structures unless separated and, if unreinforced, wall is prone to damage. Properly reinforced walls preserve evacuation routes in case of fire or blast.

Table 3-3: Multihazard design system interactions

Building System Protection Methods: Reinforcements and Conflicts								
System ID	Existing Conditions or Proposed Protection Methods	The Hazards					Discussion Issues	
		Earthquake	Flood	Wind	Security/Blast	Fire		
2	Architectural (continued)							
2E	Other Elements							
2E-1	Heavy roof (e.g., slate, tile)	X	○	X	X	X	✓	Heavy roofs are undesirable in earthquakes; slates and tiles may detach. Heavy roofs provide good protection from fire spread, but can also cause collapse of a fire-weakened structure. Almost always used on steep-sloped roofs; if wind-blown debris or a blast wave hits them, they become flying debris and dangerous to people outside the building.
2E-2	Parapet	X	✓	○	X	X	✓	Properly engineered parapet is acceptable for seismic; unbraced unreinforced masonry (URM) is dangerous. May assist in reducing the spread of fire.
3	Structural Systems							
3-1	Heavy structure: reinforced concrete (RC) masonry, RC or masonry fireproofing of steel	X	✓	✓	✓	✓	✓	Increases seismic forces, but generally beneficial against other hazards.
3-2	Light structure: steel/wood	✓	X	X	X	X	X	Decreases seismic forces, but generally less effective against other hazards.
3-3	URM exterior load bearing walls	X	X	X	X	X	X	
3-4	Concrete or reinforced CMU exterior structural walls	✓	✓	✓	✓	✓	✓	
3-5	Soft/weak first story	X	X	✓	X	X	X	Very poor earthquake performance, and vulnerable to blast. Generally undesirable for flood and wind. Elevated first floor is beneficial for flood if well constructed, but should not be achieved by a weak structure that is vulnerable to wind or flood loads.

Table 3-3: Multihazard design system interactions

Building System Protection Methods: Reinforcements and Conflicts							
System ID	Existing Conditions or Proposed Protection Methods	The Hazards					Discussion Issues
		Earthquake	Flood	Wind	Security/Blast	Fire	
<b>3</b>	<b>Structural Systems (continued)</b>						
3-6	Indirect load path	X	○	X	X	X	Undesirable for highly stressed structures, and fire-weakened structure is more prone to collapse. Not critical for floods.
3-7	Discontinuities in vertical structure	X	○	X	X	X	Undesirable for highly stressed structures; causes stress concentrations, and fire-weakened structure is more prone to collapse. Not critical for floods.
3-8	Seismic separation joints	✓	○	○	○	X	Possible path for toxic gases to migrate to other floors.
3-9	Ductile detailing and connections/ steel	✓	○	✓	✓	○	Provides a tougher structure that is more resistant to collapse.
3-10	Ductile detailing/ RC	✓	○	✓	✓	○	Provides a tougher structure that is more resistant to collapse.
3-11	Design for uplift (wind)	✓	○	✓	✓	○	Necessary for wind; may assist in resisting seismic or blast forces.
3-12	Concrete masonry units, hollow clay tile around exit ways and exit stairs	X	○	○	X	✓	May create torsional structural response and/or stress concentration in earthquakes in frame structures unless separated, and if unreinforced wall is prone to damage. Properly reinforced walls preserve evacuation routes in the event of fire or blast.
<b>4</b>	<b>Building Envelope</b>						
<b>4A</b>	<b>Wall Cladding</b>						
4A-1	Masonry veneer on exterior walls	X	X	X	X	○	In earthquakes, material may detach and cause injury. In winds and attacks, may detach and become flying debris hazard. Flood forces can separate veneer from walls.
<b>4B</b>	<b>Glazing</b>						
4B-1	Metal/glass curtain wall	✓	○	X	X	X	Fire can spread upward behind the curtain wall if not properly fire-stopped. Not blast-resistant without special glass and detailing. Light weight reduces earthquake forces.
4B-2	Impact-resistant glazing	○	○	✓	✓	X	Can cause problems during fire suppression operations, limiting access and smoke ventilation.

Table 3-3: Multihazard design system interactions

Building System Protection Methods: Reinforcements and Conflicts							
System ID	Existing Conditions or Proposed Protection Methods	The Hazards					Discussion Issues
		Earthquake	Flood	Wind	Security/Blast	Fire	
5	Utilities (No significant impact)						
6	Mechanical						
6-1	HVAC system designed for purging in the event of fire	○	○	○	✓	✓	Can be effective in reducing chemical, biological, or radiological (CBR) threat if it has rapid shut-down and efficient dampers, and is located in an airtight building.
6-2	Large rooftop-mounted equipment	✗	✓	✗	✗	○	Vulnerable to earthquake and wind forces. Raises equipment above flood level.
7	Plumbing and Gas (No significant impact)						
8	Electrical (No significant impact)						
9	Fire Alarm (No significant impact)						
10	Communications and Information Technology (IT) (No significant impact)						
11	Equipment Operations and Maintenance (O&M) (No significant impact)						
12	Security (No significant impact)						
12A	Perimeter Systems (No significant impact)						
12B	Interior Security (No significant impact)						
12C	Security System Documents (No significant impact)						
13	Security Master Plan (No significant impact)						

SOURCE: FEMA 426, *REFERENCE MANUAL TO MITIGATE POTENTIAL TERRORIST ATTACKS AGAINST BUILDINGS*, 2003

**Notes:**

The table refers to typical school structures: steel frame, concrete block or RC walls, wood frame, 1-2 stories suburban, 2-4 stories urban.

## 3.6 References

American Institute of Architects (AIA), 1998. *Buildings at Risk, Multi-Hazard Design for Earthquakes, Winds and Floods*, Washington, DC.

AIA, 2007. *AIA Handbook for Disaster Assistance Programs*, AIA Communities by Design: Disaster Assistance Program, Revised August 24, 2007.

Arnold, C., 1993. *Reconstruction After Earthquakes*, Chapter V, “Tokyo, Japan 1923 and 1945,” Building Systems Development, Inc., Palo Alto, CA.

American Society of Civil Engineers (ASCE) 2005. *Minimum Design Loads for Buildings and Other Structures*, ASCE 7-05, Structural Engineering Institute, Reston, VA.

ASCE, 2010. *Minimum Design Loads for Buildings and Other Structures*, ASCE 7-10, Structural Engineering Institute, Reston, VA.

Bendimerad, F., 1996. “Earthquake Scenarios in Three Cities. San Francisco, Los Angeles and Tokyo,” Proceedings of the 11th World Conference on Earthquake Engineering, Acapulco, Mexico.

Federal Emergency Management Agency (FEMA), 2003a. *Reference Manual to Mitigate Potential Terrorist Attacks Against Buildings*, FEMA 426, Washington, DC.

FEMA, 2003b. *The NEHRP Recommended Provisions for Seismic Regulation for New Buildings*, FEMA 450, Washington, DC.

FEMA, 2003c. *Primer to Design Safe School Projects in Case of Terrorist Attacks*, FEMA 428, Washington, DC.

National Fire Protection Association (NFPA), 1989. *Special Report on Educational Property Structure Fires in the United States*.

NFPA, 2009a. *NFPA 101: Life Safety Code*, 2009 Edition, Quincy, MA, 2009.



## Design Guide

for Improving School Safety  
in Earthquakes, Floods, and High Winds

# 4 Making Schools Safe From Earthquakes

## 4.1 Introduction

This chapter outlines the earthquake risk to schools and the processes and methods that can be used to reduce it. An explanation of the nature and probability of earthquakes is provided, together with procedures for determining the earthquake threat to specific locations and for evaluating the vulnerability of a school building. An assessment of the scope and effectiveness of seismic building codes is followed by a description of current methods of designing for seismic resistance in new buildings and upgrading existing buildings. Lastly, this chapter presents guidance for school districts, facility planners, and designers on determining acceptable risk and the use of performance-based design.

## 4.2 The Nature and Probability of Earthquakes

**A**lthough earthquakes cannot be prevented, modern science and engineering provide tools that can be used to reduce their effects. Science can now identify, with considerable accuracy, where earthquakes are likely to occur and what forces they will generate. This information is readily available and can be obtained for local geographic regions (see Section 4.2.3).

### 4.2.1 Earthquakes and Other Geologic Hazards

Earthquakes have long been feared as one of nature's most terrifying phenomena. Early in human history, the sudden shaking of the earth and the death and destruction that resulted were seen as mysterious and uncontrollable. We now understand the origin of earthquakes and know that they must be accepted as a natural environmental process. Scientific explanations, however, have not lessened the terrifying nature of the earthquake experience. Other types of phenomena sometimes accompany seismic ground shaking and are generally identified as geologic hazards:

- **Liquefaction** occurs when loose granular soils and sand in the presence of water change temporarily from a solid to a liquid state when subjected to ground shaking. Soils that are loose, not well graded, and saturated with water are prone to liquefaction. These conditions often occur near waterways such as rivers, lakes, and bays, but not always. In addition to the soil type, the probability of liquefaction also depends on the depth from the surface to the vulnerable soil layer, and the intensity of ground motion. Further, the results of liquefaction can vary from a small, uniform ground settlement across a site, to loss of foundation bearing, resulting in extreme ground settlement and horizontal movement of tens of feet (called lateral spreading). Lastly, the risk of liquefaction is directly dependent on the earthquake risk. Due to this complex set of conditions, damage potential from liquefaction is difficult to map. For all but the smallest projects, many building jurisdictions in seismic areas require that the liquefaction potential be assessed in a site-specific geotechnical report, particularly in areas of known potential vulnerability. On sites where liquefaction is more than a remote possibility, the likely results of liquefaction at the ground surface or at the building foundations is also estimated. Small settlements may be tolerated without mitigation. Larger potential settlements can be prevented by site remediation measures, if economically justified. Building on sites with potential massive liquefaction and lateral spreading may not be cost effective. Officials in some regions of high seismicity have developed maps of local areas that are potentially susceptible to liquefaction and require site-specific investigation before building/permitting begins.



- **Landslides**, which involve the slipping of soil and rock on sloping ground, can be triggered by earthquake ground motion (see Figure 4-1). The shaking from earthquakes can cause landslides, depending on the slope, type, and configuration of soil stratum. Landslides can cause damage to improvements built within the slide area or near the top of the slide, ranging from complete destruction to distortion from relatively small vertical or lateral movements. Sites can also be threatened by landslides occurring uphill, sometimes completely offsite and quite a distance away.

Similar to liquefaction, accurate probability of land sliding is difficult to map on a regional or national scale, and this threat is normally identified in site-specific geologic hazard studies. Also similar to liquefaction, the largest portion of the risk may be a triggering event. In some cases, stabilizing small areas at risk of potential landslides may be possible and cost effective. Stabilizing larger areas at risk of landslides may not be feasible. Some regions of high seismicity have developed maps of the areas susceptible to landslides based on average slopes, geologic soil types, and the past history of sliding. Building jurisdictions require site-specific investigations for sites within these susceptible zones.



**Figure 4-1:**  
School in Anchorage, AK,  
1964, severely damaged  
by earthquake-induced  
landslide

SOURCE: NATIONAL  
INFORMATION SERVICE FOR  
EARTHQUAKE ENGINEERING,  
UNIVERSITY OF CALIFORNIA,  
BERKELEY

- **Tsunamis** are seismic wave movements in the ocean that travel at high speed and may result in large coastal waves of 30 feet or more. They are sometimes, and incorrectly, called tidal waves. Researchers have studied tsunamis for many years. Sites near large bodies of

water at elevations 50 feet or less above the water surface are susceptible. Although similar to storm surge, the height and the potential velocity of a tsunami wave represent a separate hazard and must be mapped separately. In addition to dependence on local conditions, quantification of the risk from tsunamis is difficult because not every earthquake generates such a wave. Studies considering the individual characteristics of the site and the facility are required to establish the risk and identify possible mitigating measures.

- **Seiches** are similar to tsunamis, but take the form of sloshing in closed lakes or bays; they have the potential to cause serious damage, although such occurrences have been very rare.

For all of the above geologic hazards, the only truly effective defense is the application of good land-use practices that limit development in hazard-prone locations. Seismic design and construction is aimed at reducing the consequences of seismic ground shaking, which is the primary cause of damage and casualties from an earthquake.

### 4.2.2 Earthquakes: A National Problem

The U.S. Congress recognized earthquakes as a national problem in 1977 when it passed legislation authorizing the National Earthquake Hazards Reduction Program (NEHRP) to reduce risks to life and property in the United States that result from earthquakes. NEHRP has supported considerable research and hazard mitigation efforts since that time.

Most people now know that, although most frequent in California and Alaska, earthquakes are not restricted to just a few areas in the United States. In fact, two of the greatest earthquakes in U.S. history occurred not in California, but near New Madrid, Missouri, in 1811 and 1812. In the International Building Code (IBC) (ICC, 2009), the most common model building code in use in the United States and its territories, buildings on sites with a low enough seismic risk that specific design for seismic forces is not required are classified as Seismic Design Category (SDC) A. As shown in Figure 4-2, 37 of 50 States have regions with sufficient seismic risk to require designs more stringent than SDC A. The likelihood of a damaging earthquake occurring west of the Rocky Mountains, and particularly in California, Oregon, Washington, Alaska, and Utah, is much greater than it is in the East, Midwest, or South. However, the New Madrid, MO, and Charleston, SC, regions are subject to potentially more severe earthquakes with a lesser probability. According to the IBC design maps, and the USGS hazard maps, on which they are based, other locations should also plan for intermediate ground motions.



In California, schools are further protected by the Field Act of 1933, which mandated additional requirements relating to design qualifications, plan checking, and site inspection. The Field Act is discussed in more detail in Section 4.3.2.

The following graphics explain some earthquake terminology and characteristics of ground motion.

## What Earthquakes Do

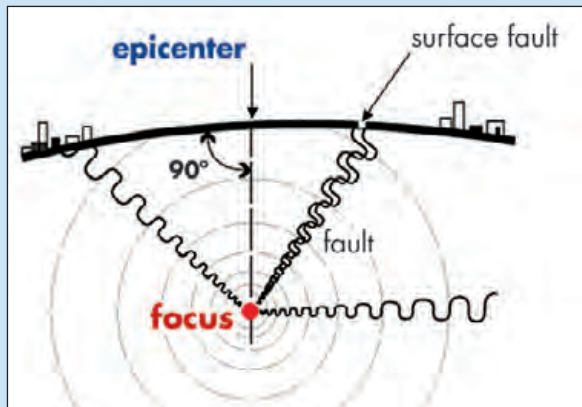

### The Origin of Earthquakes

This diagram explains some of the common terms used in talking about earthquakes. Waves of vibration radiate out from the fault break.

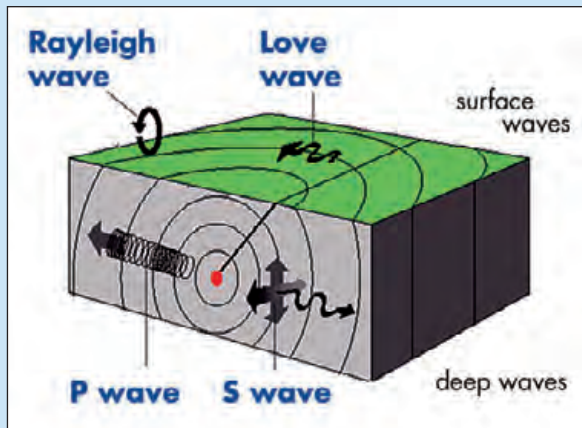

### Types of Seismic Waves

Four main types of waves radiate from a fault break. The P or Primary wave, a back-and-forth motion, arrives first, followed by the S wave (secondary or shear) that is more of a rolling motion. These are deep waves that travel through the earth to the surface. The Love and Rayleigh waves, named after their discoverers, travel along the earth's surface.



### Motion at Site

Scratch left on a floor by a kitchen range in the 1933 Long Beach earthquake that shows the random nature of earthquake motion.



## Acceleration Forces

... NEWTON'S SECOND LAW OF MOTION

**F = MA**

force      mass      acceleration

### Forces and Gravity

Because ground motion waves produce inertial forces within structures, these forces obey Newton's Second Law of Motion. This fundamental equation establishes the forces for which buildings must be designed to resist earthquakes.

**NEWTON'S APPLE**

acceleration is measured in "gs".

one **g** is the acceleration due to gravity

**1.0 g = 32 feet/second**



### Acceleration

The acceleration, or the rate of change of the velocity of the waves that set the building in motion, is used in an equation, derived from Newton's Second Law of Motion to estimate the percentage of the building mass or weight that must be dealt with as a horizontal force.



one "g" parachute team



four "g" roller coaster



nine "g" airforce display team



0.0001 "g" human perception

### Acceleration

Some common examples of acceleration. The skydivers are falling under the action of gravity, 1g.

## Period and Resonance

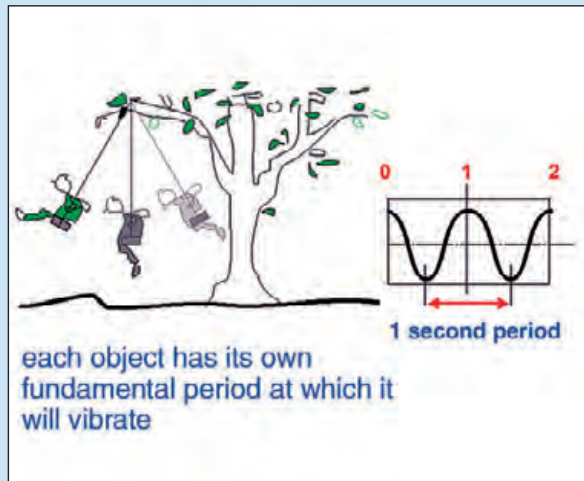

### Fundamental Period and Resonance

Every object has a fundamental period at which it vibrates if it is set in motion. It cannot vibrate at another period unless it is dragged back and forth. The ground also has a fundamental period. If an object is set in motion by an external force such as ground shaking, which is at the fundamental period of the object, the result will be “resonance” and the motion of the object will tend to increase. When you push a child on a swing, you instinctively give it a push at its fundamental period, which results in an enjoyable increase in the motion with very little force applied.

Similarly, if the ground pushes a building with the same period as the motion, the accelerations in the building will increase, perhaps four or five times.

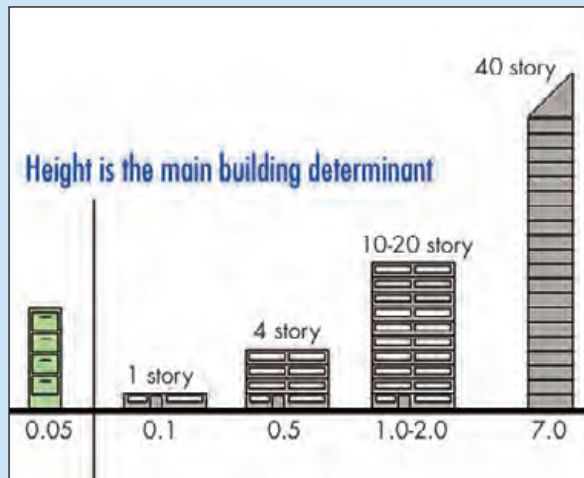

### Fundamental Period in Seconds

This shows typical periods for structures. The main determinant of period is building height and proportion; thus, a tall slender object will have a long period and sway back and forth quite slowly while the 40-story building will sway gently back and forth once every 7 seconds.

SOURCE: ARNOLD AND ALEXANDER, 2001.

### 4.2.3 Common Measures of Earthquakes

Perhaps the most familiar measure of earthquakes is the Richter Magnitude, devised by Professor Charles Richter of the California Institute of Technology in 1935. Richter’s scale is based on the maximum amplitude of certain seismic waves recorded on a standard seismograph at a distance of 100 kilometers (km) from the earthquake epicenter. Because the instruments are unlikely to be exactly 100 km from the source, Richter devised a method to allow for the diminishing of wave

amplitude with increased distance. The Richter scale is logarithmic, and each unit of magnitude indicates a ten-fold increase in wave amplitude. The energy level is multiplied by approximately 31 times for a unit increase in Richter magnitude scale. The scale is open-ended, but a magnitude of about 9.5 represents the largest earthquake scientists now expect within the current understanding of movement in the earth's crust.

Magnitude is not a measure of damage, but a physical characteristic of an earthquake. An earthquake with magnitude 6.7 that occurs in a remote area may cause no damage to manmade structures, but one with the same magnitude can cause considerable damage if it occurs close to an urban area.

Among scientists, the Richter Magnitude has been replaced by the Moment Magnitude, a similar measure of energy that is based on the physical characteristics of the fault rupture, which is a more useful measure for large events. The Moment Magnitude scale produces values similar to the Richter scale, and for damaging earthquakes, values are normally in the 5.5 to 8.0 range, although magnitudes over 9.0 also occur.

The level of earthquake damage is often measured by intensity scales; one common scale used in the United States is the Modified Mercalli Intensity (MMI) scale, reported in Roman Numerals from I to XII. MMI is often incorrectly used to measure the size of an earthquake. In fact, the MMI is assigned to small areas, like zip codes, based on the local damage to structures or movements of soil. Many MMIs can be associated with a single earthquake because the shaking, and therefore the damage, diminishes as the distance to the epicenter increases. Although the MMI is useful for the purpose of comparing damage from one event to another (particularly events for which little or no instrumental measurements are available), it is very subjective, and scientists and engineers prefer instrumental measurements of the ground shaking to measure intensity.

Scientists and engineers need measures of the damaging characteristics of earthquakes to compare the inherent risk at different locations, and to develop design solutions to limit damage to acceptable levels. The universal characteristic of earthquakes, and the one that can be measured most precisely, is ground motion. Extensive networks of instruments are now employed on the ground and in buildings and other structures to record continuously the motions during an earthquake. The ever-growing database of earthquake recordings can be analyzed in various ways to develop appropriate measures of intensity that best predict potential damage to buildings and other structures, nonstructural systems, and the possibility of liquefaction and landslides.

Table 4-1 shows significant earthquakes (Magnitude VI or over) that occurred in 47 of the 50 U.S. States between 1568 and 1989.



Table 4-1: Known historic (1558–1989) earthquakes in 47 U.S. States

Number of Quakes with Reported Maximum Modified Mercalli Intensity (MMI) of:			
State	VI <sup>a</sup>	VII <sup>b</sup>	VII+
Alabama	5	7	—
Alaska	41	21	13
Arizona	11	3	1
Arkansas	8	3	2
California	329	131	66
Colorado	19	1	—
Connecticut	2	1	—
Delaware	—	1	—
Florida	2	—	—
Georgia	5	—	—
Hawaii	30	13	10
Idaho	12	4	2
Illinois	18	12	—
Indiana	5	2	—
Kansas	4	2	—
Kentucky	8	1	—
Louisiana	1	—	—
Maine	7	2	—
Massachusetts	8	7	3
Michigan	1	1	1
Minnesota	3	—	—
Mississippi	2	—	—
Missouri	14	2	3
Montana	35	4	5
Nebraska	4	2	—
Nevada	28	10	8
New Hampshire	7	2	—
New Jersey	5	1	—
New Mexico	29	10	8
New York	16	6	2
North Carolina	5	2	—
North Dakota	1	—	—

**Table 4-1: Known historic (1558–1989) earthquakes in 47 U.S. States**

Number of Quakes with Reported Maximum Modified Mercalli Intensity (MMI) of:			
State	VI <sup>a</sup>	VII <sup>b</sup>	VII+
Ohio	9	5	1
Oklahoma	9	2	—
Oregon	10	1	—
Pennsylvania	7	1	—
Rhode Island	1	—	—
South Carolina	17	2	1
South Dakota	6	—	—
Tennessee	12	2	—
Texas	7	1	—
Utah	31	8	5
Vermont	1	—	—
Virginia	12	1	1
Washington	37	6	3
West Virginia	1	—	—
Wyoming	8	1	—

Notes:

- a. Felt by all. Some heavy furniture moved; a few instances of fallen plaster. Damage slight.
- b. Damage negligible in buildings of good design and construction; slight to moderate in well-built ordinary structures; considerable damage in poorly built or badly designed structures; some chimneys broken.

### 4.2.4 Determination of Local Earthquake Hazards

Earthquake hazard maps are available in model codes, such as the IBC, and standards such as ASCE 7. Values representing ground shaking hazard are mapped for building periods of 0.2 second and 1.0 second. Examples of these maps are shown in Figure 4-3. Building codes and standards allow engineers to calculate the appropriate spectral response value for other building periods, as shown in Figure 4-4. Mapped values are for a hypothetical earthquake with a 2-percent probability of exceedance in 50 years. Site class, which is a measure of soil conditions at the building site, is also described in building codes and standards and influences the determination of ground shaking hazard at the building site. Site Class A represents hard rock, and Site Class E represents a very soft site with potential soil failure.

**1.0 sec Spectral Acceleration (%g) with 2% Probability of Exceedance in 50 Years**

site: NEHRP B-C boundary

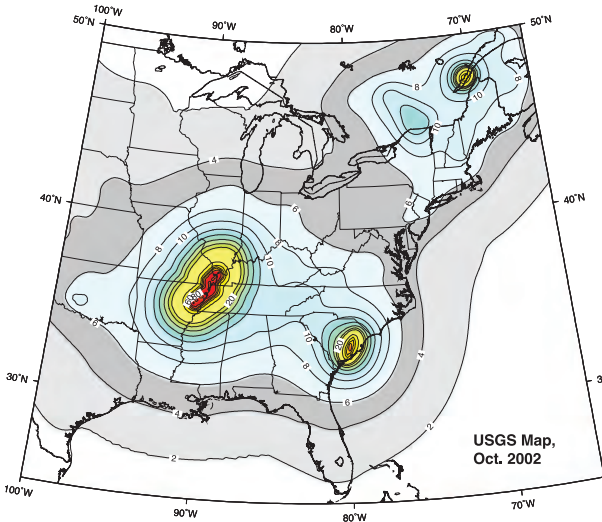

**0.2 sec Spectral Acceleration (%g) with 2% Probability of Exceedance in 50 Years**

site: NEHRP B-C boundary

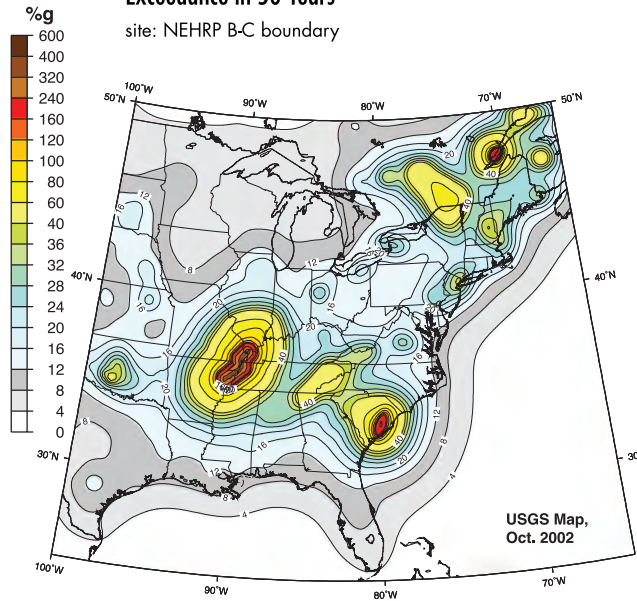
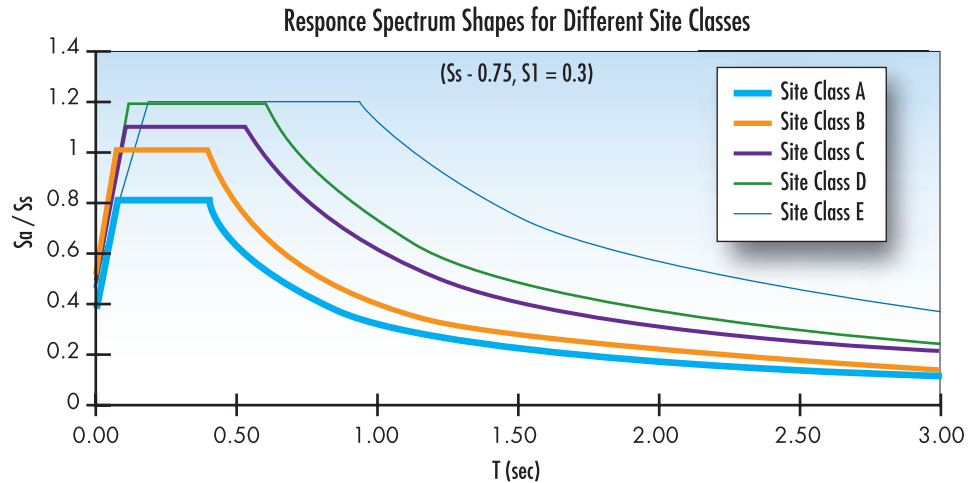

Figure 4-3: Examples of national seismic hazard maps

Figure 4-4: Representative shapes of building code (or design) response spectra for different soils



More detailed information on the seismic hazard than is shown on the code maps, such as those in the IBC or ASCE 7, can be obtained from the USGS Earthquake Hazards Program Web site at <http://earthquake.usgs.gov/>. The USGS provides more detailed earthquake hazard maps for general regions such as the western, central, and eastern United States. The USGS provides more localized seismicity information for any location in the United States on the basis of latitude and longitude or zip code. This information can be obtained by downloading the Ground Motion Parameter Calculator at <http://earthquake.usgs.gov/hazards/designmaps/javacalc.php>. The calculator provides the seismic design parameters generally needed to conform to current building codes.

### 4.3 Vulnerability: What Earthquakes Can Do to Schools

**M**uch of the information developed on what earthquakes can do to schools comes from California because of the prevalence of earthquakes in that State. In general, the seismic performance of newer buildings has been good, although considerable costly and dangerous nonstructural damage still occurs. California public school design and construction has been subject to strict regulation since 1933, which undoubtedly contributes to good performance. Many of the damage examples shown in this section are of older school buildings, which reflects the continued use of long-lived school buildings constructed in the early 20th century.

#### 4.3.1 Vulnerability of Schools

Older unreinforced masonry school buildings present a very high seismic risk, and have been prohibited by law in California since the mid-1930s following severe damage to schools of this type in the 1933 Long Beach earthquake. Mid-rise nonductile reinforced concrete frame structures pose an even greater risk. “Nonductile” refers to the frame’s lack of ductility (flexibility), or ability to deform considerably before breaking (see Figure 4-5). Reinforced concrete frames are made ductile by introducing an appropriate, code-specified amount of specifically designed steel reinforcing. Unfortunately, the need for this ductility was not recognized in seismic codes until the mid-1970s, so a large inventory of nonductile structures is still in use (see Figure 4-6).

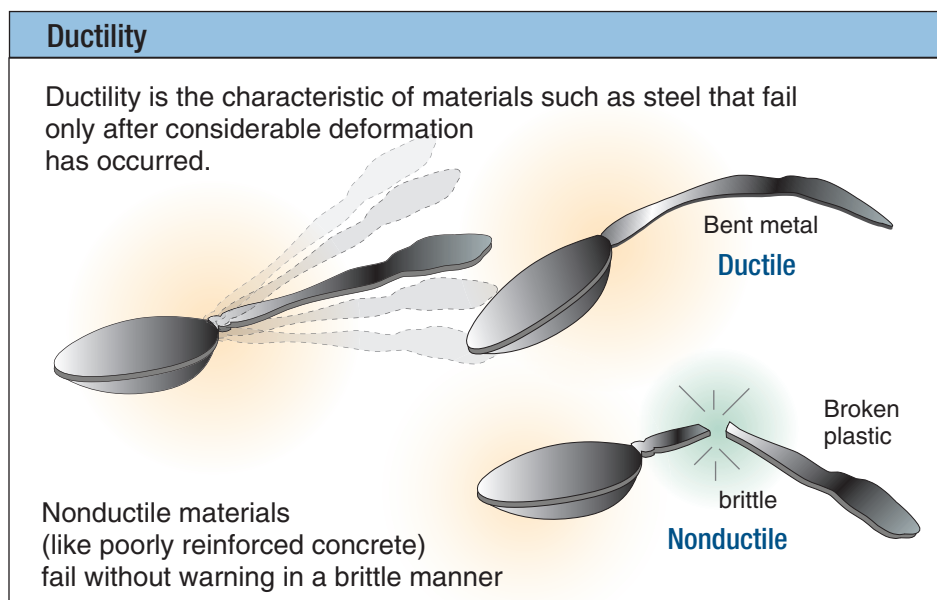

**Figure 4-5: Ductility**

SOURCE: ARNOLD AND ALEXANDER, 2001

**Figure 4-6:**  
**Collapse of portion of**  
**nonductile concrete**  
**frame school structure,**  
**Helena, MT, 1935**

SOURCE: NATIONAL  
 INFORMATION SERVICE FOR  
 EARTHQUAKE ENGINEERING,  
 UNIVERSITY OF CALIFORNIA,  
 BERKELEY



Wood frame structures perform effectively, provided that they are well constructed with code-specified nailing of shear walls and properly detailed roof-to-wall connections. Good maintenance, ensuring continued protection against moisture and insects, is also critical to the performance of wood frame structures. Newer structures, employing frames and fewer walls, also perform effectively if well designed and constructed in accordance with building codes. Their response differs from that of shear wall structures, which are stiff and resistant to lateral forces. Frame structures can be more flexible than rigid shear wall structures because the forces on the structural members are reduced.

Modular structures, often used as temporary classrooms, are liable to topple off their foundations during an earthquake, unless securely attached and braced. This damage is not life-threatening, but makes the building unusable; fractured power, gas, and waste lines may be a hazard (see Figure 4-7).

**Figure 4-7:**  
**Modular classrooms**  
**pushed off their**  
**foundations; note stairs**  
**at left, Northridge, CA,**  
**1994**

SOURCE: GARY MCGAVIN,  
 REDLANDS, CA





If the structure type employs long-span roof and floor members, seismic forces may cause excessive drift, or sway, which can damage non-structural components, such as hung ceilings, light fixtures, light partitions, and contents. Storage units, filing cabinets, and library shelving in any type of structure can be hazardous if not properly braced (see Figure 4-8), as can heavy equipment (see Figure 4-9). Piping, ductwork, electrical conduits, and communication pathways (cable trays) may also be damaged. Broken pipes can create additional hazards in the form of flooding or loss of water for fire protection.

School occupants are particularly vulnerable to nonstructural damage. Although students and staff may duck under desks and be safe from falling objects such as lighting fixtures and ceiling tiles, ceiling components that fall in hallways and stairs can make movement difficult, particularly if combined with power failure and loss of lighting. Wall-mounted televisions or ceiling-mounted liquid crystal display (LCD) projectors are common in schools and present additional falling hazards.

Pendant light fixtures may fall if they are not securely attached and not designed to swing freely (see Figure 4-10). Large glass walls and windows, not designed to accommodate inter-story drift due to seismic forces, present another hazard for



**Figure 4-8:**  
Fallen filing cabinets and shelves, Northridge, CA, 1994

SOURCE: GARY MCGAVIN, REDLANDS, CA



**Figure 4-9:**  
Fallen shop equipment, Coalinga, CA, 1983

SOURCE: GARY MCGAVIN, REDLANDS, CA

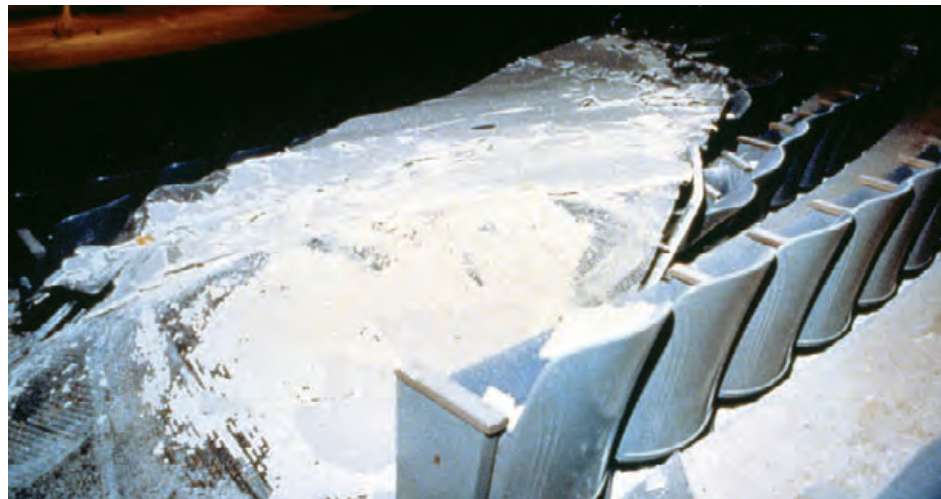

**Figure 4-10:**  
**Fallen light fixtures, library, Coalinga, CA, 1983**

SOURCE: GARY MCGAVIN, REDLANDS, CA

**Figure 4-11:**  
**Fallen heavy lath and plaster ceiling across auditorium seating, Northridge, CA, 1994**

SOURCE: GARY MCGAVIN, REDLANDS, CA



densely occupied classrooms as demonstrated in California schools that have suffered from recent earthquakes. Incorporating glazing designed to resist wind-borne debris and physical attack, as well as glazing support systems that can accommodate inter-story drift, can reduce the hazards caused by earthquake motion.

Heavy lath and plaster ceilings in older auditoriums (and assembly buildings) can also be dangerous depending on their attachment and materials (see Figure 4-11).

### 4.3.2 Earthquake Damage to Schools

Most available information on earthquake damage to schools comes from California. Its high incidence of earthquake activity has led to the adoption of sophisticated seismic building codes for all buildings, and special plan checking and inspection requirements, enforced by the State, for school buildings.

Considering the number of significant earthquakes in California since the early years of the 20th century, severe structural damage to schools and casualties has been relatively limited, except in the Long Beach earthquake of 1933. No student has been killed or seriously injured in a California school during an earthquake since 1933. In the Long Beach earthquake, which struck at 5:55 p.m. on March 10, 1933, damage to unreinforced masonry (URM)



school buildings was so severe that there would have been many casualties had they been occupied (see Figures 4-12, 4-13, and 4-14). As a result, the State passed the Field Act within a month of the earthquake.



**Figure 4-12:**  
Damage to the John Muir  
School, Long Beach, CA,  
1933

SOURCE: NATIONAL INFORMATION  
SERVICE FOR EARTHQUAKE  
ENGINEERING, UNIVERSITY OF  
CALIFORNIA, BERKELEY

The Field Act required that all public school buildings be designed by a California-licensed architect or structural engineer, that plans be checked by the then Department of General Services, and that construction be continuously inspected by qualified independent inspectors retained by the local school board. The Department of General Services set up a special division, staffed by structural engineers, to administer the provisions of the Act. The Field Act, which is still enforced today, has greatly reduced structural damage to California schools.

The earthquake also resulted in the passage of the Riley Act, which governed the design of all buildings, with a few exceptions. The Riley Act required all buildings in the State be designed to a specified lateral force, and effectively outlawed unreinforced masonry construction.



**Figure 4-13:**  
Damage to shop building, Compton Junior High School,  
Long Beach, CA, 1933

SOURCE: NATIONAL INFORMATION SERVICE FOR EARTHQUAKE  
ENGINEERING, UNIVERSITY OF CALIFORNIA, BERKELEY

**Figure 4-14:**  
A dangerous  
passageway between  
two buildings,  
Polytechnic High School,  
Long Beach, CA, 1933

SOURCE: NATIONAL  
INFORMATION SERVICE FOR  
EARTHQUAKE ENGINEERING,  
UNIVERSITY OF CALIFORNIA,  
BERKELEY



In 1952, Kern County, in the Bakersfield region, some 70 miles north of Los Angeles, experienced a series of earthquakes. Two groups of earthquakes occurred; the first, in the last week of July, included one with a magnitude of 7.6 on the Richter scale. The second group occurred in late August, and one earthquake, near the city of Bakersfield, had a magnitude of 5.9 on the Richter scale. Ten deaths resulted from the July earthquake and two from the August earthquake.

The Bakersfield earthquakes are of particular interest because the incidence of school damage is comparable to that resulting from earthquakes striking today in regions where seismic codes have not been adopted and enforced due to the rarity of seismic events (see Figures 4-15, 4-16, and 4-17).

**Figure 4-15:**  
A heavy corridor lintel  
ready to fall, Emerson  
School, Bakersfield,  
Kern County, CA, 1952

SOURCE: NATIONAL  
INFORMATION SERVICE FOR  
EARTHQUAKE ENGINEERING,  
UNIVERSITY OF CALIFORNIA,  
BERKELEY







**Figure 4-16:**  
**Overturned shop equipment and failed light fixtures, Kern County, CA, 1952**

SOURCE: NATIONAL INFORMATION SERVICE FOR EARTHQUAKE ENGINEERING, UNIVERSITY OF CALIFORNIA, BERKELEY



**Figure 4-17:**  
**Destroyed exit corridor, Bakersfield, Kern County, CA, 1952**

SOURCE: NATIONAL INFORMATION SERVICE FOR EARTHQUAKE ENGINEERING, UNIVERSITY OF CALIFORNIA, BERKELEY

There were no school-related casualties in 1952, as the earthquakes occurred outside school hours. At that time, the Field Act had been in force for nearly 20 years, and the newer schools had been constructed to conform to its requirements. Of the 58 masonry schools in the region, 18 had been constructed after the Field Act. Of these, one school constructed of grouted reinforced brick and incurred approximately 1 percent, or moderate, damage. Of the 40 non-Field Act schools, 1 collapsed, 15 suffered severe damage, and 14 suffered moderate damage. In the Bakersfield City School District, 175 classrooms and 6,500 students were displaced and only about 10 classrooms were quickly put back in service. Nonstructural damage to ceilings and light fixtures was considerable.

Other States have experienced similar damage to URM and early reinforced concrete structures. Schools in Helena, MT, suffered considerable damage in 1935 (see Figure 4-18). In 1949, several URM schools in Seattle were severely damaged, resulting in one fatality (see Figures 4-19 and 4-20). At Puyallup High School, three boys on a stage just managed to escape when the roof collapsed (see Figure 4-21). The furniture and contents also sustained widespread damage (see Figure 4-22).

**Figure 4-18:**  
**Typical school damage,**  
**Helena, MT, 1935**

SOURCE: NATIONAL  
INFORMATION SERVICE FOR  
EARTHQUAKE ENGINEERING,  
UNIVERSITY OF CALIFORNIA,  
BERKELEY







**Figure 4-19:**  
**The student body president was killed here by falling brickwork, Seattle, WA, 1949**

SOURCE: EARTHQUAKE ENGINEERING RESEARCH INSTITUTE, OAKLAND, CA. PHOTO FROM A.E. MILLER COLLECTION, UNIVERSITY OF WASHINGTON ARCHIVES



**Figure 4-20:**  
**Another dangerous entry collapse, Seattle, WA, 1949**

SOURCE: EARTHQUAKE ENGINEERING RESEARCH INSTITUTE, OAKLAND, CA. PHOTO FROM SEATTLE SCHOOL ARCHIVES

**Figure 4-21:**  
**Collapse of roof over stage, Seattle, WA, 1949**

SOURCE: NATIONAL INFORMATION SERVICE FOR EARTHQUAKE ENGINEERING, UNIVERSITY OF CALIFORNIA, BERKELEY



**Figure 4-22:**  
**Damage to library shelving, Seattle, WA, 1949**

SOURCE: NATIONAL INFORMATION SERVICE FOR EARTHQUAKE ENGINEERING, UNIVERSITY OF CALIFORNIA, BERKELEY





### 4.3.3 Significant School Damage in U.S. Earthquakes

In the Anchorage, AK, earthquake of 1964, which registered 8.4 on the Richter scale, a number of public schools were damaged, but none collapsed. The earthquake occurred on Good Friday at 5:36 p.m. when the schools were unoccupied. The most seriously damaged school (shown in Figure 4-1) was subsequently demolished. At the West Anchorage High School (see Figures 4-23 and 4-24), a two-story nonductile concrete-frame and shear-wall classroom wing suffered severe structural damage and the near total failure of a number of columns. Structural distortion also created a number of severe glass breakages. The second floor was removed during reconstruction and the first floor was repaired and retained. In the San Fernando, CA, earthquake of 1971, there were no injuries and no schools collapsed; however, the earthquake caused \$13.2 million in damages (in 1971 dollars), and 100 pre-Field Act schools were demolished within 1½ years after the earthquake.



**Figure 4-23:**  
Severe structural damage  
to the West Anchorage High  
School, Anchorage, AK, 1964

SOURCE: NATIONAL INFORMATION  
SERVICE FOR EARTHQUAKE  
ENGINEERING, UNIVERSITY OF  
CALIFORNIA, BERKELEY

A survey of 1,544 public school buildings showed that only three schools sustained severe damage as a result of the magnitude 6.9 Loma Prieta (San Francisco Bay area) earthquake of 1989. A portable classroom near Santa Cruz was rocked off its unbraced and unanchored supports. An elementary school in Los Gatos was subjected to severe shaking, but damage was limited to nonstructural and contents shifting, except in one classroom wing, where ground heaving raised and cracked the floor slab, jamming a door and window shut.





**Figure 4-24:**  
**Brittle failure at nonductile concrete column,**  
**West Anchorage High School, 1964**

SOURCE: NATIONAL INFORMATION SERVICE FOR EARTHQUAKE ENGINEERING, UNIVERSITY OF CALIFORNIA, BERKELEY



## Tagging

A post-earthquake evaluation procedure has been developed in California that employs colored placards, or “tags,” affixed to buildings, that show that the building has been inspected and indicate the level of safety. The colors of the tags and their safety level classification follow:

-  A red tag indicates **UNSAFE**: Extreme hazard, may collapse. Imminent danger of collapse from an aftershock. Unsafe for occupancy or entry, except by authorities.
-  A yellow tag indicates **LIMITED ENTRY**: Dangerous condition believed to be present. Entry by owner permitted only for emergency purposes and only at own risk. No usage on continuous basis. Entry by public not permitted. Possible major aftershock hazard.
-  A green tag indicates **INSPECTED**: No apparent hazard found, although repairs may be required. Original lateral load capacity not significantly decreased. No restriction on use or occupancy.

SOURCE: ATC, 1995

A San Francisco High School suffered severe structural cracking from the Loma Prieta earthquake. The school was constructed in 1920 as an automobile manufacturing building and was structurally upgraded in 1947. Restoration costs after the earthquake were estimated at \$10 million.

Total restorations for the San Francisco school district were estimated to be \$30 million; for Oakland, the district losses were \$1.5 million. Though undamaged, an elementary school in San Francisco was closed because of the potential collapse of a nearby elevated freeway structure, which was considered a hazard to the building and its occupants. Hazards from unbraced and unanchored nonstructural items were evident in many buildings, including pendant-mounted light fixtures, suspended acoustical ceilings, and unanchored furniture and contents such as filing cabinets and shelving.

In the Northridge, CA, earthquake of 1994, 17 school buildings were red tagged and 89 buildings were yellow-tagged. All of the public schools in this area, except for one, were capable of receiving students after post-earthquake debris was cleared. In some schools, portions of the campus and certain structures needed to be closed to students until further evaluations could be performed, but the schools were able to open (McGavin 1994). Examples of nonstructural damage are provided in Figures 4-25, 4-26, and 4-27). If the schools had been in session, nonstructural damage could have caused injuries. In 1995, the California Seismic Safety Commission (CSSC) recommended that a percentage of future school bond proceeds be used to abate life-threatening nonstructural and building contents deficiencies in public schools (1995). In 1999, legislation was passed for public schools to address securing nonstructural elements, and in 2003 detailed guidelines were published to aid public schools in identifying and correcting nonstructural hazards (California Emergency Management Agency, 2003).



**Figure 4-25:**  
Ceiling damage,  
Northridge, CA, 1994

SOURCE: GARY MCGAVIN,  
REDLANDS, CA

**Figure 4-26:**  
Damage to ceramic kiln,  
including fractured gas  
line, Northridge, CA,  
1994

SOURCE: GARY MCGAVIN,  
REDLANDS, CA



**Figure 4-27:**  
Line of suspended light fixtures fallen on teacher's  
station, Northridge, CA, 1994

SOURCE: EARTHQUAKE ENGINEERING RESEARCH INSTITUTE,  
OAKLAND, CA, AND GARY MCGAVIN, REDLANDS, CA





### 4.3.4 Consequences: Casualties, Financial Loss, and Operational Disruption

Casualties in California schools have been few, primarily due to regulation by the Field Act and by chance. Significant Alaskan and California earthquakes, from Santa Barbara (1925) to Northridge (1984) have all occurred outside of school hours. Consequently, the effects of a major earthquake when schools are fully occupied have not been experienced. In other regions, casualties have been few; in the Seattle earthquake of 1949, two school children died in Tacoma when bricks cascaded onto exit ways. The closure of other Seattle schools for spring vacation averted fatalities and serious injuries in similar building failures.

The impact of school closure as a result of damage is the loss of public service and severe disruption for students, faculty, and staff. Ultimately, the taxpayer bears the costs, but this is spread over the whole community, the State, and the Federal Government. Typically, schools are self-insured and do not purchase insurance on the private market. For a private school, closure means a serious loss of revenue; in addition to the costs of repair, the students may not return if the school is closed for a long time. Therefore, obtaining insurance may be a prudent measure.

As with any of the natural hazards reviewed in this manual, an earthquake can close a school, keeping the school district from doing its main job (i.e., teaching students). The length of the closure will depend on the severity and types of damage. It may also depend on whether the building was fully insured or whether disaster assistance will be available quickly enough to allow speedy repairs and reconstruction. Sometimes repairs are put on hold, pending a decision on whether the building should be repaired or condemned.

School closures from natural disasters also result in social and psychological difficulties for students, parents, faculty, staff, and the administration during the time the school is not usable, as illustrated by the quotations.

- *“From the standpoint of children and families, after an impact is a particularly bad time for schools to be closed. Damaged homes and neighborhoods are dangerous and depressing places. Children are often left with no safe place to play when yards, playgrounds, and recreational programs are lost, no one to play with when playmates and friends are forced to relocate and parents are too busy dealing with survival and rebuilding issues to have much time for them.”*
- *“The closing of a local school is highly disruptive to social networks and, if it becomes permanent, can rob a neighborhood of its identity and cohesion. One of the most dramatic effects that can occur to a severely impacted community is when a school is closed for a long time, maybe even permanently, due to regional depopulation after homes are destroyed.”*
- *“Getting schools reopened quickly has been found to be an important step toward rebuilding the community as a whole.”*
- *“An understudied area is the long-term effect of major disasters on the education and development of children.”*
- *“The shock of being uprooted and moved to a new school, even temporarily, can be very difficult for children. The effects can be particularly traumatic if they occur at a critical developmental time, such as the senior year with its preparation for college and graduation festivities.”*

SOURCE: THE HEINZ CENTER, HUMAN LINKS TO COASTAL DISASTERS, H. JOHN HEINZ III CENTER FOR SCIENCE, ECONOMICS AND THE ENVIRONMENT, WASHINGTON, DC, 2002

## 4.4 Scope, Effectiveness, and Limitations of Codes

**S**eismic design is highly developed, complex, and strictly regulated by codes and standards. Seismic codes present criteria for the design and construction of new structures subject to earthquake ground motions in order to minimize the hazard to life and to improve the capability of essential facilities to function after an earthquake. To these ends, current building codes provide the minimum requirements necessary for reasonable and prudent life safety.

Seismic code requirements include:

- A methodology for establishing the design ground motion at any site based on seismicity and soil type
- Procedures for the seismic analysis of the building structure and key nonstructural components and systems
- Some detailed design requirements for materials, systems, and components
- Definitions of irregular building configurations and limitations on their use
- Building height limitations related to structural type and level of seismicity

Building codes and seismic design practices evolved rapidly as the result of intensive research and development in the United States and elsewhere during the second half of the 20th century.

Building codes for cities, States, or other jurisdictions throughout the United States are typically based on the adoption, sometimes with more restrictive local modification, of a model building code. Up until the mid-1990s, there were three primary model building code organizations: Building Officials and Code Administrators International, Inc. (BOCA), International Conference of Building Officials (ICBO), and Southern Building Code Congress International, Inc. (SBCCI). In 1994, these three organizations united to found the ICC, a nonprofit organization dedicated to developing a single set of comprehensive and coordinated national model construction codes. The first code published by ICC was the 2000 IBC, which reflected the *NEHRP Recommended Provisions for Seismic Regulations for New Buildings and Other Structures* (NEHRP Provisions) (2000a). Later editions of the IBC reference ASCE 7 for its seismic provisions. Some jurisdictions in the country may still be using the Uniform Building Code (UBC) seismic provisions (its final update was in 1997), though most have adopted or are preparing to adopt the IBC. Provisions of the IBC are predominantly used throughout the United States.

### 4.4.1 The Background of Seismic Provisions in Building Codes

Building code provisions for seismic design have been available in the United States since the initial regulations for the protection of buildings against earthquakes first appeared in the UBC in California in 1927. Beginning in the 1950s, the earthquake-resistant design provisions of the three model codes used as the basis for building regulation in the United States were based on recommendations developed by the seismology committee of the Structural Engineers Association of California and contained in their publication known as the “Blue Book.”

In the early 1980s, FEMA—one of the lead agencies in NEHRP—issued a contract to the Building Seismic Safety Council for the update and continued development of a seminal document, *Tentative Provisions for the Development of Seismic Regulations for Buildings*, ATC-3-06, originally published in 1978 by the ATC, a non-profit research foundation set up after the San Fernando earthquake of 1978 to recommend improvements in the seismic building code. Provisions of ATC-3-06 subsequently provided the basis for the NEHRP Provisions (2000a), which was released in 1985 and continues to serve as the primary resource document for earthquake design requirements in ASCE 7.

Building codes such as the IBC currently address seismic design primarily through reference to ASCE 7.

### 4.4.2 Seismic Codes and Schools

Seismic codes are concerned primarily with types of structures and include few provisions that relate to specific occupancies. The IBC (2009) categorizes school buildings with occupant load greater than 250 as Type III: “...buildings and other structures that represent a substantial hazard to human life in the event of failure....” Type III buildings are assigned an Importance Factor of 1.25. This means that the seismic force calculated by use of the Equivalent Lateral Force (ELF) procedure would be multiplied by 1.25 so that schools are designed to a higher standard than ordinary buildings.

As previously mentioned, California K-12 schools are regulated by the Field Act, which singles out the design and construction of schools to resist earthquakes and is an important model for other States to consider. However, the Field Act is not a code; it requires that schools be designed by a licensed architect or structural engineer, that plans and specifications be checked by the Department of the State Architect, and that independent testing and inspection be conducted during construction.

Implementing the nonstructural provisions of the seismic code will significantly reduce damage to nonstructural components and reduce the potential for school closings because of ceiling and lighting damage, partition failures, and loss of essential utilities. In the case of nonstructural provisions, the code goes somewhat beyond the structural objective of only reducing the risk of casualties. However, recent experience with earthquakes has shown that nonstructural damage to schools can be dangerous to the occupants, costly to repair, and operationally disruptive. Guidance on design to reduce nonstructural damage is provided in FEMA 74, *Reducing the Risks of Nonstructural Earthquake Damage: A Practical Guide* (1994).

### 4.4.3 The Effectiveness of Seismic Codes

Building codes originated in the effort to reduce risk to health and safety, rather than reducing property loss, but as they evolved, they indirectly and directly assisted in reducing building damage. They establish the minimum standards for safety commensurate with affordability and other impacts such as measures that might create extreme inconvenience to occupants or seriously reduce the building's functional efficiency.

Engineers generally agree that, based on California's earthquake experience, regulation through a properly enforced seismic code has largely fulfilled the intent of ensuring an acceptable level of safety to avoid death and injury. The performance of school buildings in recent California earthquakes substantiates this; structural damage has been minimal in schools designed to the most recent seismic codes. Application of the Field Act ensures that schools are designed and constructed to more rigorous standards than most other buildings.

However, the effectiveness of seismic codes is subject to some qualifications:

- The standards of code enforcement vary considerably, and smaller jurisdictions may not have trained engineering staff to conduct effective plan checks and inspections.
- The nonstructural provisions of the seismic codes are often not adopted at the local level. Nonstructural components have not been regulated to the same level of care as structural components, and have been the cause of considerable economic loss and disruption of operation.
- The code can be misinterpreted and design errors made due to inexperience of both designers and building officials.



## 4.5 Evaluating Existing Schools for Seismic Risk and Specific Risk Reduction Methods

Several FEMA-sponsored publications are available to assist in the evaluation process. These guides, first developed in the 1980s, are used extensively. This section also provides a simple seismic evaluation checklist that focuses specifically on schools.

The procedures for seismic evaluation of schools are listed below in the order in which they would be used, starting with a simple screening process.

### 4.5.1 Rapid Visual Screening

The Rapid Screening Procedure (RSP) published in FEMA 154, *Rapid Visual Screening of Buildings for Potential Seismic Hazards: A Handbook* (2002b), is intended as an initial step in identifying hazardous buildings and their deficiencies. Buildings identified by this procedure to be potentially hazardous must be examined in more detail by a professional engineer experienced in seismic design. Because this screening is aimed at providing a low-cost method of identifying large inventories of potentially hazardous buildings for public and private owners, and thus reducing the number of buildings that should be subject to a more detailed evaluation, it is designed to be performed from the street without benefit of entry into a building.

The screening procedures can be completed in 20 to 30 minutes for each building. In some cases, hazardous details may not be visible, and seismically hazardous structures will not be identified as such. Nonstructural interior components are not evaluated. Conversely, buildings identified as potentially hazardous may prove to be adequate.

The RSP is most useful for large school districts, municipalities, or even States that wish to get an economical preliminary evaluation of the seismic risks faced by their school inventory. The procedure is not intended to provide a definitive evaluation of the individual buildings.

The RSP is based on a visual survey of the building and a data collection form used to collect critical information. The collection form includes space for sketches and a photo of the building, as well as pertinent earthquake-safety related data. FEMA 154 provides the inspector with background information and data required to complete the form (see Figure 4-28). The procedure is designed to be performed by individuals with some knowledge of buildings who are not necessarily professional architects or engineers and are not familiar with seismic design. It has been successfully applied by

**Rapid Visual Screening of Buildings for Potential Seismic Hazards**  
 FEMA 154 Data Collection Form

**HIGH Seismicity**

Address: \_\_\_\_\_ Zip: \_\_\_\_\_

Other Identifiers: \_\_\_\_\_

No. Stories: \_\_\_\_\_ Year Built: \_\_\_\_\_

Screened: \_\_\_\_\_ Date: \_\_\_\_\_

Total Floor Area (sq. ft.): \_\_\_\_\_

Building Name: \_\_\_\_\_

Use: \_\_\_\_\_

PHOTOGRAPH

Score: \_\_\_\_\_

OCCUPANCY		SOIL		TYPE						FALLING HAZARDS				
Assembly	Club	Office	Number of Persons		A	B	C	D	E	F	Overhead	Parapet	Cantilever	Other
Commercial	Medical	Residential	0-10	11-100	Very Rock	High Rock	Low Rock	Soft Soil	Stiff Soil	Fill	Chimney	Parapet	Cantilever	Other

BASIC SCORE, MODIFIERS, AND FINAL SCORE, S														
BUILDING TYPE	W1	W2	S1	S2	S3	S4	C1	C2	C3	PC1	PC2	RM1	RM2	URM
Base Score	4.4	3.8	2.8	3.0	3.3	3.8	3.8	2.5	2.8	1.6	2.8	3.4	3.8	1.8
Mid Rise (8 to 7 stories)	NA	NA	+0.2	+0.8	NA	+0.1	+0.6	+0.8	+0.2	NA	+0.2	+0.4	+0.4	0.0
High Rise (7+ stories)	NA	NA	-0.5	-0.2	NA	-0.8	+0.8	-0.2	-0.2	NA	-0.4	NA	-0.2	0.0
Struct. Irregularity	-3.5	-2.0	-1.0	1.5	NA	-1.0	-1.0	-1.5	-1.0	-1.0	NA	-1.0	-1.0	-1.0
Plan Irregularity	-0.5	-0.5	-0.5	-0.5	-0.5	-0.5	-0.5	-0.5	-0.5	-0.5	-0.5	-0.5	-0.5	-0.5
Pre-Cast	0.0	-1.0	-1.0	-0.8	-0.8	-0.8	-0.8	-1.2	-1.0	-0.2	-0.8	-0.8	-1.0	-0.8
Play-Structure	+3.4	+2.4	+1.4	+1.4	NA	+1.8	NA	+1.4	+2.4	NA	+3.4	NA	+2.4	+2.0
Soil Type C	0.0	-0.1	-0.4	-0.4	-0.4	-0.1	-0.1	-0.4	-0.4	-0.4	-0.4	-0.4	-0.4	-0.4
Soil Type D	0.0	-0.8	-0.6	-0.6	-0.6	-0.6	-0.4	-0.6	-0.6	-0.4	-0.6	-0.6	-0.6	-0.6
Soil Type E	0.0	-0.8	-1.2	-1.2	-1.0	-1.0	-0.8	-1.0	-0.8	-0.8	-1.2	-0.8	-0.8	-0.8

**FINAL SCORE, S**

COMMENTS: \_\_\_\_\_

Detailed Evaluation Required  
YES NO

\* = Estimates, subjective, or otherwise based  
 (NA) = Not Applicable  
 (0) = Zero  
 (1) = One  
 (2) = Two  
 (3) = Three  
 (4) = Four  
 (5) = Five  
 (6) = Six  
 (7) = Seven  
 (8) = Eight  
 (9) = Nine  
 (10) = Ten  
 (11) = Eleven  
 (12) = Twelve  
 (13) = Thirteen  
 (14) = Fourteen  
 (15) = Fifteen  
 (16) = Sixteen  
 (17) = Seventeen  
 (18) = Eighteen  
 (19) = Nineteen  
 (20) = Twenty  
 (21) = Twenty-one  
 (22) = Twenty-two  
 (23) = Twenty-three  
 (24) = Twenty-four  
 (25) = Twenty-five  
 (26) = Twenty-six  
 (27) = Twenty-seven  
 (28) = Twenty-eight  
 (29) = Twenty-nine  
 (30) = Thirty  
 (31) = Thirty-one  
 (32) = Thirty-two  
 (33) = Thirty-three  
 (34) = Thirty-four  
 (35) = Thirty-five  
 (36) = Thirty-six  
 (37) = Thirty-seven  
 (38) = Thirty-eight  
 (39) = Thirty-nine  
 (40) = Forty  
 (41) = Forty-one  
 (42) = Forty-two  
 (43) = Forty-three  
 (44) = Forty-four  
 (45) = Forty-five  
 (46) = Forty-six  
 (47) = Forty-seven  
 (48) = Forty-eight  
 (49) = Forty-nine  
 (50) = Fifty  
 (51) = Fifty-one  
 (52) = Fifty-two  
 (53) = Fifty-three  
 (54) = Fifty-four  
 (55) = Fifty-five  
 (56) = Fifty-six  
 (57) = Fifty-seven  
 (58) = Fifty-eight  
 (59) = Fifty-nine  
 (60) = Sixty  
 (61) = Sixty-one  
 (62) = Sixty-two  
 (63) = Sixty-three  
 (64) = Sixty-four  
 (65) = Sixty-five  
 (66) = Sixty-six  
 (67) = Sixty-seven  
 (68) = Sixty-eight  
 (69) = Sixty-nine  
 (70) = Seventy  
 (71) = Seventy-one  
 (72) = Seventy-two  
 (73) = Seventy-three  
 (74) = Seventy-four  
 (75) = Seventy-five  
 (76) = Seventy-six  
 (77) = Seventy-seven  
 (78) = Seventy-eight  
 (79) = Seventy-nine  
 (80) = Eighty  
 (81) = Eighty-one  
 (82) = Eighty-two  
 (83) = Eighty-three  
 (84) = Eighty-four  
 (85) = Eighty-five  
 (86) = Eighty-six  
 (87) = Eighty-seven  
 (88) = Eighty-eight  
 (89) = Eighty-nine  
 (90) = Ninety  
 (91) = Ninety-one  
 (92) = Ninety-two  
 (93) = Ninety-three  
 (94) = Ninety-four  
 (95) = Ninety-five  
 (96) = Ninety-six  
 (97) = Ninety-seven  
 (98) = Ninety-eight  
 (99) = Ninety-nine  
 (100) = One hundred

Figure 4-28: Example of rapid visual screening information form

architectural and engineering students. The methodology enables the inspector to identify significant seismic-related defects and to arrive at a numerical score, with a hazard ranking of 1–6.

Surveyed buildings are divided into two categories: those that are expected to have acceptable seismic performance, and those that may be seismically hazardous and should be studied further. A score of 2 is suggested as a “cut-off” based on current seismic knowledge (i.e., if a building has a hazard ranking of 2 or less, it should be investigated by a structural engineer experienced in seismic design).

**4.5.2 Systems Checklist for School Seismic Safety Evaluation**

Table 4-2 represents a simplified version of ASCE 31, *Seismic Evaluation of Existing Buildings* (2003); also see Section 4.5.3. This simplified version focuses on structural and nonstructural systems and

components found in schools. The evaluation questions are organized by system basis and are designed to establish whether the building is a potential seismic hazard and, if so, what its specific vulnerabilities are. Use of the checklist requires some seismic engineering knowledge, but the information can be obtained by visual inspection and no engineering calculations are necessary. The checklist can be used in conjunction with the RSP procedure, and augments the RSP analysis because it requires access to the building and review of design drawings, both of which are likely to be available to evaluate a public school building.

The checklist can also be useful in interdisciplinary discussions between consultants and school district personnel, and can assist consultants in fee negotiation with the client.

Table 4-2: School seismic safety evaluation checklist

System Identifier	Evaluation Question	Evaluation Y or N or comment	Guidance	Data References
1	<b>Site</b>			
	Is there is an active fault on or adjacent to the site?		If suspected, site-specific geologic investigations should be performed.	Local building department, State geologist, local university, or local geotechnical consultant
	Does the site consist of stiff or dense soil or rock?		If softer soils that can lead to force amplification are suspected, site-specific geologic investigations should be performed.	Local building department, State geologist, local university, or local geotechnical consultant
	Are post-earthquake site egress and access secured?		Alternative routes, unlikely to be blocked by falling buildings, power lines, etc., are desirable.	Inspection by district personnel/architect
	Are utility and communications lifelines vulnerable to disruption and failure?		Security of the entire utility and communications network is the issue: the school may be impacted by off-site failures.	Inspection on site by district personnel and Mechanical/Electrical/Plumbing (M/E/P) consultants; for off site, contact local power and communications providers
	Are there alternate or backup sources for vital utilities?		Alternate sources increase the probability of the school remaining functional after an event, particularly if the school is used for post-earthquake shelter.	Inspection personnel and district personnel, M/E/P consultants, and local utility suppliers
1	<b>Site</b>			
	Are building setbacks adequate to prevent battering from adjacent buildings?		Inadequate spaces between building walls are common in dense urban settings.	ASCE 31, Section 4.3.1.2
	Is there adequate space on the site for a safe and “defensible” area of refuge from hazards for building occupants?		Outside spaces can be used as safe post-earthquake assembly areas for school occupants and possibly the community.	Inspection personnel and district personnel/architect/local emergency staff
2	<b>Architectural</b>			
	<b>Configuration</b>			
	Is the architectural/ structural configuration regular?		Irregular vertical and horizontal configurations, such as re-entrant corners and soft first stories, may lead to significant stress concentrations.	ASCE 31, Section 4.3.2

Table 4-2: School seismic safety evaluation checklist

System Identifier	Evaluation Question	Evaluation Y or N or comment	Guidance	Data References
2	<b>Architectural</b>			
	<b>Planning and Function</b>			
	<b>Are exit routes, including stairs, protected from damage and clear from nonstructural elements or contents that might fall and block exit ways?</b>		Schools sometimes have large unbraced lockers in hallways, or store other materials, such as tall filing cabinets or bookcases, that may fall and block exits.	Inspection by district personnel  ASCE 31, Section 4.8.11.
	<b>Ceilings</b>			
	<b>Are suspended ceilings braced and correctly attached at walls?</b>		Suspended ceilings easily distort (particularly in light and flexible frame structures), thus causing ceiling panels to fall if not properly designed and constructed.	ASCE 31, Section 4.8.2.
	<b>Are heavy plaster suspended ceilings securely supported and braced?</b>		Heavy lath and plaster ceilings in older schools are very dangerous if poorly supported.	ASCE 31, Section 4.8.2.
	<b>Partitions and Space Division</b>			
	<b>Are partitions that terminate at a hung ceiling braced to the structure above?</b>		Partitions need support for out-of-plane forces. Attachment to a suspended ceiling is inadequate.	ASCE 31, Section 4.8.1.
	<b>Are masonry or hollow tile partitions reinforced or braced, particularly those surrounding exit stairs?</b>		Heavy partitions develop strong earthquake forces because of their stiffness and mass, and are prone to damage. They are particularly dangerous around stairs and exit ways and occupied classrooms.	ASCE 31, Section 4.8.1
	<b>Other Elements</b>			
	<b>Are exterior entrance canopies and walkways engineered to ensure no collapse?</b>		Post-earthquake safety of these structures is critical to ensure safe exit after an event.	ASCE 31, Section 4.8.8
	<b>Are parapets, appendages, etc., securely attached and braced to the building structure?</b>		Unreinforced masonry parapets are especially vulnerable, as are items such as cornices, signs, and large satellite communication dishes.	ASCE 31, Section 4.8.8
	<b>Are heavy lockers, library shelves, and vertical filing cabinets that could fall on people braced to the structure?</b>		These can topple and injure occupants, and also block exit ways.	ASCE 31, Section 4.8.11

Table 4-2: School seismic safety evaluation checklist

System Identifier	Evaluation Question	Evaluation Y or N or comment	Guidance	Data References
3	<b>Structural System</b>			
	Is there a continuous load path from the foundation to the roof?		This is an important characteristic to ensure good seismic performance. This also sometimes relates to irregularity in configuration.	Engineer to check design of school structure ASCE 31, Section 4.3.1.
	Does the structure provide adequate redundancy in the event of the loss of some structural supports?		Typical characteristics of redundancy include multiple lines of resistance and multiple bays within each line to distribute lateral forces.	ASCE 31, Section 4.4.1.1.1 and Section 4.4.2.1.1
	Is all load-bearing structural masonry reinforced according to code?		Unreinforced masonry has limited ductility and cannot withstand large earthquake-induced repetitive displacements.	Engineer to check against local code requirements
	Is the structure's reinforced concrete designed to seismic code later than 1976?		The reinforced concrete codes changed in 1976, and structures designed before these codes were adopted may be inadequate.	Check date of design, and edition of code used
	Is the structure's wood frame well maintained, with little or no deterioration?		Wood framing is subject to attack by termites and water damage, both of which can seriously weaken the structure.	School district personnel to inspect
	Are horizontal structural members securely connected to walls and columns?		Good connections between all structural members are very important for structural integrity.	Structural engineer to check ASCE 31, Section 4.6.1
	Are horizontal diaphragms correctly designed and constructed with necessary chords and collectors?		Large diaphragm openings and the edges of diaphragms must be designed to ensure forces are properly transmitted to walls and frames.	Structural engineer to check ASCE 31, Section 4.5.1
4	<b>Building Envelope</b>			
	<b>Wall Cladding</b>			
	Is the building cladding attached to structural frames so that it can accommodate drift?		Frames are flexible and cladding must be detailed to accommodate calculated drifts and deformations.	ASCE 31, Section 4.8.4
	Are heavy veneer facing materials such as brick or stone securely attached to the structural walls?		Shear wall structures are very stiff and carry large earthquake forces; heavy attachments must be securely attached.	Structural engineer to check design and field condition
	Are heavy roofing materials such as tile and slate securely attached to the structure?		Installation of these materials over points of egress may be dangerous, because they may fall off and hit someone exiting the building and may also litter the exit path with debris.	IBC Table 1507.3.7

Table 4-2: School seismic safety evaluation checklist

System Identifier	Evaluation Question	Evaluation Y or N or comment	Guidance	Data References
4	<b>Building Envelope</b>			
	<b>Glazing</b>			
	Are glazing and other panels attached so that they can accommodate drift?		Glazing must be installed with sufficient bite, and adequate space between glass and metal.	ASCE 31, Section 4.8.4
	Is the glazing material inserted into a surrounding structure that limits drift and racking?		Glazing is dependent on the surrounding structure to limit racking.	Structural engineer to inspect framing and structural conditions
5	<b>Utilities</b>			
	Are building utility distribution systems well supported and adequately braced?		Flexible connections may be necessary where utilities enter the building.	ASCE 31, Section 4.8.13.
6	<b>Mechanical</b>			
	Is heavy mechanical equipment adequately secured and are isolators provided with snubbers?		Spring-isolated equipment must be restrained from jumping off isolators.	ASCE 31, Section 4.8.12
	Is the heating piping properly braced and provided with expansion joints?		Bracing and expansion joints increase the likelihood of continued post-event function.	Inspection by school district personnel and M/E/P consultants
	Is ductwork properly supported and braced?		Proper support and bracing increase the likelihood of continued post-event function.	Inspection by school district personnel and M/E/P consultants
	Are water heaters and other tanks securely braced?		Gas heaters or tanks with flammable or hazardous materials must be secured against toppling.	ASCE 31, Section 4.8.12
7	<b>Plumbing</b>			
	Are plumbing lines adequately supported and braced?		Protection of joints is especially important.	ASCE 31, Section 4.8.13
	Is fire protection piping correctly installed and braced?		Correct installation and bracing increase the likelihood of continued post-event function.	Inspection by school district personnel and M/E/P consultants
	Are ducts and piping that pass through seismic joints minimized and provided with flexible connections?		Differential movement between sections of the building can cause breakage and leaks in pipes and ducts if no provision is made for movement. If walls at joint are firewalls, penetrations should be fireproofed.	ASCE 31, Section 4.8.13.2



Table 4-2: School seismic safety evaluation checklist

System Identifier	Evaluation Question	Evaluation Y or N or comment	Guidance	Data References
8	<b>Electrical</b>			
	Are suspended lighting fixtures securely attached, braced, or designed to sway safely?		Older suspended lighting fixtures have performed badly in earthquakes and are an injury hazard.	ASCE 31, Section 4.8.3
	Are light fixtures supported in a ceiling, braced, and provided with safety wires?		Light fixtures within a grid often fall when the grid is distorted, unless the fixtures are secured with safety wires.	ASCE 31, Section 4.8.3
	Is heavy electrical equipment adequately secured?		Switch gear and transformers are heavy and failure can shut down the electrical system.	ASCE 31, Section 4.8.12
9	<b>Fire Alarm</b>			
	Is the fire alarm system connected to a secondary power supply?		This is also necessary to support daily operational needs, including lighting, heating, communications, etc., and if the building is used as a post-earthquake shelter.	Inspection by district maintenance personnel and M/E/P consultants
	Is the fire alarm system provided with a battery backup system capable of operating the system for 24 hours after power loss?		Required by code even if the building will not be used after an event so that the school can be evacuated.	Inspection by district maintenance personnel and M/E/P consultants
10	<b>Communications and IT Systems</b>			
	Are communications components adequately braced and supported?		Post-event communications are vital for issuing instructions to school administrators, students, faculty, and staff. Some components, such as large satellite dish antennas, are easily damaged if not properly supported.	ASCE 31, Section 4.8.12
	Are building intercom systems connected to a standby generator or battery?		Necessary to enable continued communications, whether loss of power is caused by earthquake or not.	Inspection by maintenance personnel and M/E/P consultants
11	<b>Equipment Operations and Maintenance</b>			
12	<b>Security Systems</b>			
13	<b>Security Master Plan</b>			

### 4.5.3 Seismic Evaluation of Existing Buildings

For those buildings that, as the result of a preliminary screening, are candidates for a more detailed investigation, the Building Seismic Safety Council (BSSC) developed a procedure for the systematic evaluation of any type of building (FEMA 178, *The NEHRP Handbook for the Seismic Evaluation of Existing Buildings* (1992), later updated as FEMA 310, *Handbook for Seismic Evaluation of Buildings: A Prestandard* (1998). FEMA 310 was subsequently superseded by ASCE 31 (2003), a standard of the American Society of Civil Engineers approved by the American National Standards Institute.

ASCE 31 can be used to evaluate the structural and nonstructural systems and components for any type or size of individual school building. However, the procedure focuses on evaluating whether the building or building components pose a potential earthquake-related risk to human life. The procedure does not address code compliance, damage control, or other aspects of seismic performance not related to life safety.

The ASCE 31 methodology involves answering two sets of questions: one set addresses the characteristics of 15 common structural types and the other set deals with structural elements, foundations, geologic site hazards, and nonstructural components and systems. These questions are designed to uncover the flaws and weaknesses of a building, and are in the form of positive evaluation statements describing building characteristics that are essential if the failures observed in past earthquakes are to be avoided. The evaluating architect or engineer should address each statement on the checklist and determine whether an item is compliant or non-compliant. Compliant statements identify conditions that are acceptable and non-compliant statements identify conditions in need of further investigation. The handbook also details a process for dealing with statements on the checklist that are found to be non-compliant.

The evaluation requires some basic structural calculations and a site visit. Follow-up field work is also necessary. The primary product of the evaluation is the identification building vulnerabilities that could precipitate structural or component failure. Although the procedure provides guidance on structural deficiencies, it is not intended to identify appropriate seismic retrofit options. The design engineer must understand the overall deficiencies of the building before attempting to identify retrofit design approaches. The overall deficiencies may be due to a combination of component deficiencies, inherent adverse design, construction deficiencies, deterioration, or a serious weakness in the structural and nonstructural systems.

## 4.6 Earthquake Risk Reduction Methods

**A**lthough the general principles of design are similar for new or existing schools, differences in code requirements and overall project delivery processes reflect the design freedoms for new buildings and the constraints for existing ones.

Engineering of structural and nonstructural risk reduction methods is similar for new and existing schools. New school design offers the possibility of construction on a site subject to less ground motion because of better soil conditions or further proximity to a fault. New schools can be designed with the most appropriate structural system, using known

and tested materials and a good building configuration. These possibilities are not available when retrofitting an existing school; the building may have been designed to an obsolete seismic code or no code at all, its materials may be questionable, and the building configuration and structural system may be inappropriate. Therefore, the protection of an existing school must start with a careful evaluation of its vulnerability. Seismic retrofitting is expensive and time consuming; however, an incremental retrofit procedure, as described in Section 4.6.2, can help to keep time and cost within reasonable limits by integrating retrofits into normal repairs and capital improvement projects.

### 4.6.1 Risk Reduction for New Schools

Methods of design for earthquake protection involve three main characteristics of the school: its site, its structure, and its nonstructural components.

In terms of risk reduction, the first priority is the implementation of measures that will reduce the risk of casualties to students, staff, and visitors. The second priority is the reduction of damage that leads to downtime and disruption. The third priority is the reduction of damage and repair costs.

Alternative measures to achieve these objectives are as follows, in ascending order of cost:

- New Schools Regulated by Seismic Codes
  - Provide personal protection training.
  - Evaluate code provisions against risk priorities. Evaluate whether design to current code will meet acceptable risk objectives for damage costs and reduction of downtime.
  - Consider adopting California's Field Act model for quality control of design and construction; it can be administered by a single district with specification provisions for inspection in contract documents.
  - Use performance-based design procedures if code-based design does not meet acceptable risk objectives.
- New Schools Not Regulated by Seismic Codes
  - Provide personal protection training.
  - Design to appropriate code standards on a voluntary basis.
  - Use performance-based design procedures to meet acceptable risk objectives.

- Consider adoption of seismic code; requires community-wide cooperation.

Damage reduction is common to all the objectives. The following sections give an overview of the design strategies that are used to achieve acceptable levels of protection in new schools.

**School Sites.** Protection of schools and their occupants from earthquakes depends on correct seismic design and construction to resist the estimated earthquake forces that the building could encounter at its specific site.

Because ground motion from a single earthquake may vary considerably, depending on the nature of the soil and the distance of the building from known earthquake faults, careful site selection is a critical first step in reducing the forces on the building. School sites are generally selected based on factors such as availability, student population, cost, convenience of access for the school students and staff, and general demographic concerns rather than seismicity. However, a large district that is developing a multi-school plan of new facilities should include recognition of any natural hazard vulnerabilities as a factor in the evaluation of alternative sites. A school district can reduce its seismic vulnerability in several ways:

In the late 1960s, the small school district of Portola Valley, CA, was faced with declining enrollment for its intermediate school, which was also outdated. In addition, the school was located very close to the San Andreas Fault. Concerned about seismic risk, the district deemed the site unsuitable for school purposes and sold the site to the city for \$1. The city subsequently used the site for recreational purposes.

- **Locate the building in an area of lower seismicity, where earthquakes occur less frequently or with typically smaller intensities.** Although it would be very rare for a school district to make a site selection decision based solely on seismic risk, moving a school even a few miles in some cases can make a big difference to its seismic hazard.
- **Locate the building on a soil type that reduces the hazard.** Local soil profiles can be highly variable, especially near water, on sloped surfaces, or close to faults. In an extreme case, siting on poor soils can lead to damages caused by liquefaction, land sliding, or lateral spreading of the soil. Similar buildings located less than 1 mile apart have performed in dramatically different ways in earthquakes because of differing soil conditions. Even when soil-related geologic hazards are not present, earthquake motions that have to travel through softer soils will be amplified more than those traveling through firm soils or rock. If soil types at a site are a concern, the effects of soil hazard on risk should be determined by a geotechnical or engineer. A professional should assess the potential vulnerabilities associated with differing site conditions. These vulnerabilities should be weighed against the costs, both direct and indirect, of locating the facility on soils that will result in better performance.

- **Engineer the building site to increase building performance and reduce vulnerability.** If building relocation to an area of lower seismicity or to an area with a better natural soil profile is not a cost-effective option, the soil at the designated site can sometimes be treated to reduce the hazard. For example, on a liquefiable site, the soil can be grouted or otherwise treated to reduce the likelihood of liquefaction. Soft soils can be excavated and replaced, or combined with foreign materials to make them stiffer. Alternatively, the building foundation itself can be modified to account for the potential effects of the soil, reducing the building's susceptibility to damage even if liquefaction or limited land sliding does occur. The school district should weigh the additional costs of modifying the soil characteristics or the building foundation with the expected reduction in damage and loss. However, because most schools are one or two stories in height, site area usage is considerable, and site treatment is likely to be costly.

The ELF equation in the IBC is  $V=C_s W$ , where  $V$ = the shear, or pushing, force at the base of the building, which represents the total earthquake force on the building, and  $C_s$  is a coefficient representing the estimated site acceleration (derived from maps provided in the code) and modified by factors related to the characteristics of the structure, the importance of the building, and the nature of the soil.  $W$  is the weight of the building.

In most cases, a designated school site will be accepted. Proposed construction directly over a fault is probably the only siting characteristic that would lead to rejection of an otherwise suitable location. The forces a school must be designed to withstand increase if it is near a fault, which increases the structural cost. Sites are assigned to one of six categories, from A, which represents hard rock, to F, which represents soils vulnerable to potential failure or collapse such as liquefiable soils, sensitive clays, and weak soils and clays. Variations in soil type are addressed in design by increasing or decreasing the design forces by application of a coefficient within the calculation of the ELF equation, which is used to establish the design lateral forces on the building.

**Reducing Damage to School Structures.** Minimum standards and criteria for structural design are defined in the building codes. The codes provide maps that show whether the location is subject to earthquakes and, if so, the probability of occurrence, expressed by varying levels of seismic forces for which a building must be designed. Seismic codes are adopted by State or local authorities, so a seismically-prone region could be exempt from seismic code regulations if the local community has chosen not to adopt a seismic building code. Although a seismic hazard exists, based on historic and scientific data, some communities choose to ignore the risk, because no one has experienced an earthquake in their lifetime. Such a policy should be of serious concern to school district officials, the local school board, and parents.

## How Buildings Resist Earthquakes

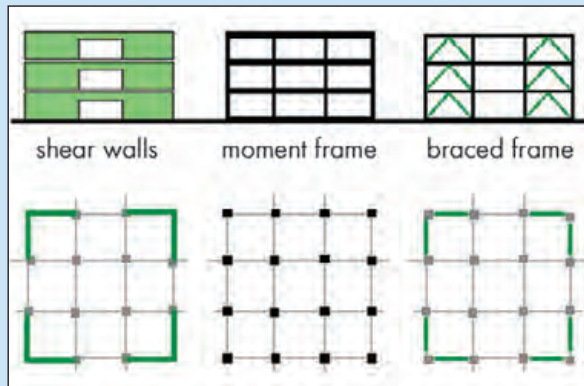

### Lateral Force Resisting Systems – Basic Types

This figure shows the basic types of lateral force resisting structural systems. They tend to be mutually exclusive (i.e., it is desirable not to mix the systems in a single building because of the different strength and stiffness characteristics of the systems). Shear walls are very stiff while moment-resistant frames are flexible. Braced systems are in between.

The systems have major architectural implications. Shear walls, which should run uninterrupted from foundation to roof, may impose major planning constraints on a building. Moment frames create unobstructed floors, but, because of their special connection requirements, are expensive. They are subject to more deformation that may result in costly damage to nonstructural components and systems. Braced frames are a common compromise.

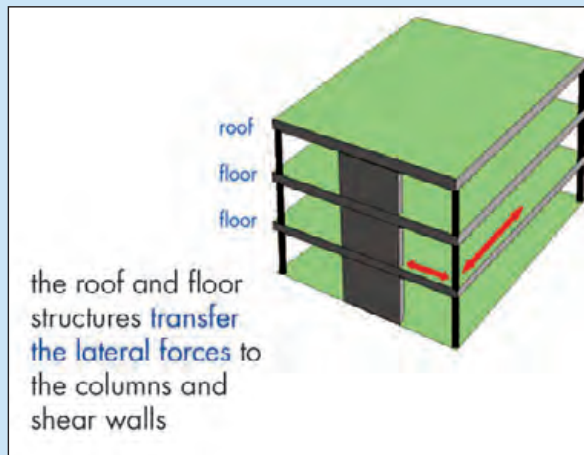

### Diaphragms

Together with the lateral force resisting system, diaphragms form a horizontal system that connects the vertical elements and carries their loads down to the foundation. Large openings in the diaphragm may limit its ability to be effective in transferring forces.

SOURCE: ARNOLD AND ALEXANDER, 2001



Although the risk may appear to be minimal, the effects of a significant event could be catastrophic. Communities with minimal risk may have no history of design for earthquakes, leaving the building stock especially vulnerable. School buildings are an important community resource (along with other essential buildings such as hospitals and fire and police stations) that should not be gambled on the avoidance of a rare event.

Reducing structural and nonstructural damage in earthquakes depends on:

- The correct application of code criteria and analytical methods. Seismic codes have become increasingly complex and a high standard of care and engineering judgment is necessary to ensure correct application.
- The appropriate selection and application of structural systems and materials. Different structural systems have varied characteristics that must be matched to the nature and purpose of the school. The following two graphics show the basic types of structural lateral force resisting systems.
- The correct design of critical elements such as frames, shear walls, and diaphragms and their connections to one another: earthquake forces expose the weak links between structural members. Serious damage and collapse is often initiated by connection failure. These critical elements provide seismic resistance and must be correctly sized, located, and detailed.
- Careful attention to key structural design principles such as provision of a direct load path and structural redundancy.
- The correct design of the connections between structural elements and nonstructural components.
- A simple and regular building configuration (its size and shape) as planning and aesthetic requirements permit. Experience has shown that certain building shapes and architectural design elements contribute to poor seismic performance and are expensive to design and build.
- A high level of quality assurance to ensure that the building is properly constructed. Careful seismic design is pointless if not properly executed.
- A high level of maintenance to ensure that the building retains its integrity over time. Corrosion of steel and termite infestation or dry rot in wood can seriously affect structural integrity.

The following graphics show some problems caused by irregular building configurations.

## Some Typical Design Problems

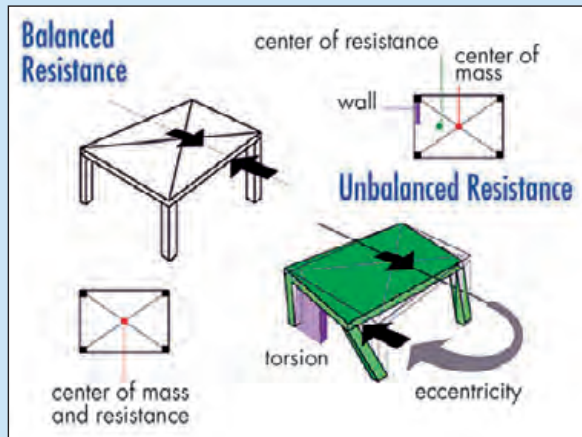

### Torsional Forces

This figure shows how torsion occurs. If the center of mass and center of resistance do not coincide, the building tends to rotate around the center of resistance.

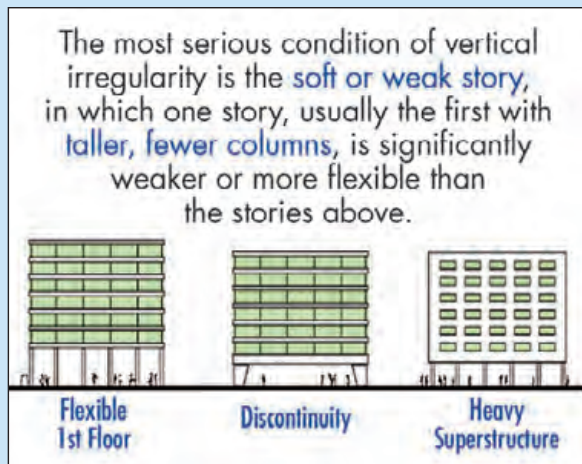

### Stress Concentrations

Stress concentration is the excessive concentration of forces at one or a few points of the building, such as a particular set of beams, columns, or walls. These few members may fail and, by a chain reaction, bring down the whole building.

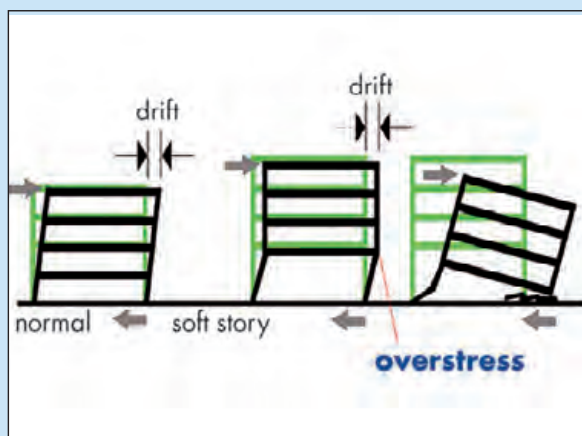

### Soft Stories

This figure shows the failure mechanism of a soft or weak story. A regular building with equal floor heights distributes its drift equally to each floor so that each is subjected to manageable drift. In the soft story building, the overall drift is the same, but the second floor connections are subject to all, or almost all, the drift, creating a failure mechanism.

SOURCE: ARNOLD AND ALEXANDER, 2001

## Torsional Forces and Stress Concentration



### Soft Stories

Typical examples of soft story-induced damage.

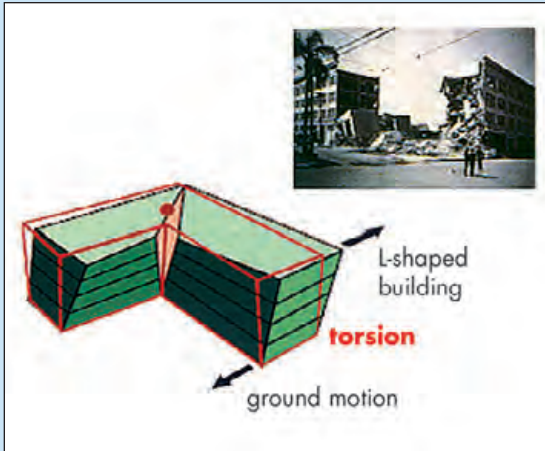

### Re-entrant Corners

Buildings with re-entrant corners (L-shape, U-shape, etc.) are subject to torsion and stress concentrations. Special design measures are necessary to counteract these tendencies. Where buildings are structurally separated to remove stress concentrations at corners, adequate separation distance must be provided to prevent damages caused by pounding (e.g., the buildings deflecting toward each other and making contact).

SOURCE: ARNOLD AND ALEXANDER, 2001

**Reducing Damage to Nonstructural Components and Systems.** Nonstructural components and systems are defined as those elements that do not contribute to the seismic resistance of the building (see Figures 4-29a and b). They typically comprise from 75 to 80 percent of the total school building value, and they provide weather protection, heating, cooling, lighting, and acoustic control for the structure. Damage to these components can be costly and render the building functionally useless even if the building structure performs in accordance with the intent of the seismic code. Nonstructural components are generally broadly classified as:

- Architectural
  - Exterior envelope – opaque or glazed, roof and wall coverings
  - Veneers

- Interior partitions
- Ceilings
- Parapets and appendages (e.g., signs and decorative elements)
- Canopies and marquees
- Chimneys and stacks
- Mechanical
  - Boilers and furnaces
  - HVAC source equipment and distribution components
- Electrical and Electronic
  - Source power equipment and distribution components
  - Source communications equipment and distribution components
  - Light fixtures
- Plumbing
  - Storage vessels and tanks
  - Piping systems
  - Hazardous materials (HazMat) distribution
- Furnishings and Interior Equipment
  - Bookcases, filing cabinets, and other storage
  - Shop and art equipment
  - HazMat storage

Figure 4-29a:  
Structural and  
nonstructural elements  
of a building

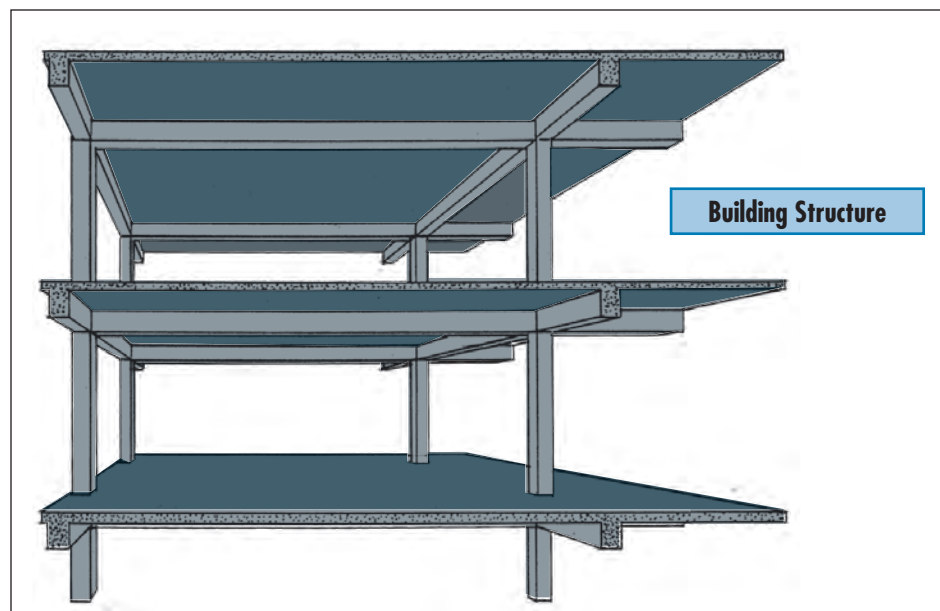

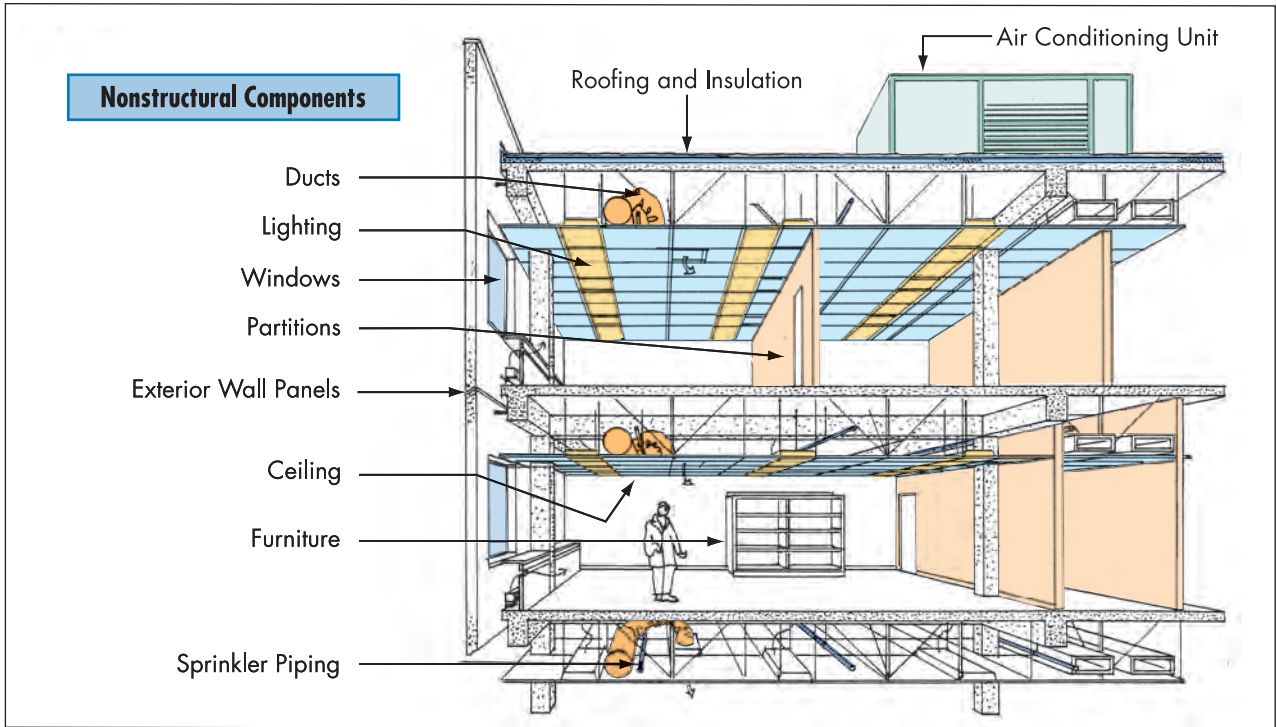

Figure 4-29b: Structural and nonstructural elements of a building

Reduction of damage to nonstructural components depends on using methods of support and bracing the components to avoid failure (see examples in Figures 4-30, 4-31, 4-32, and 4-33). Seismic codes provide the design force for which the nonstructural components must be designed, together with a number of specific design requirements that must be followed.

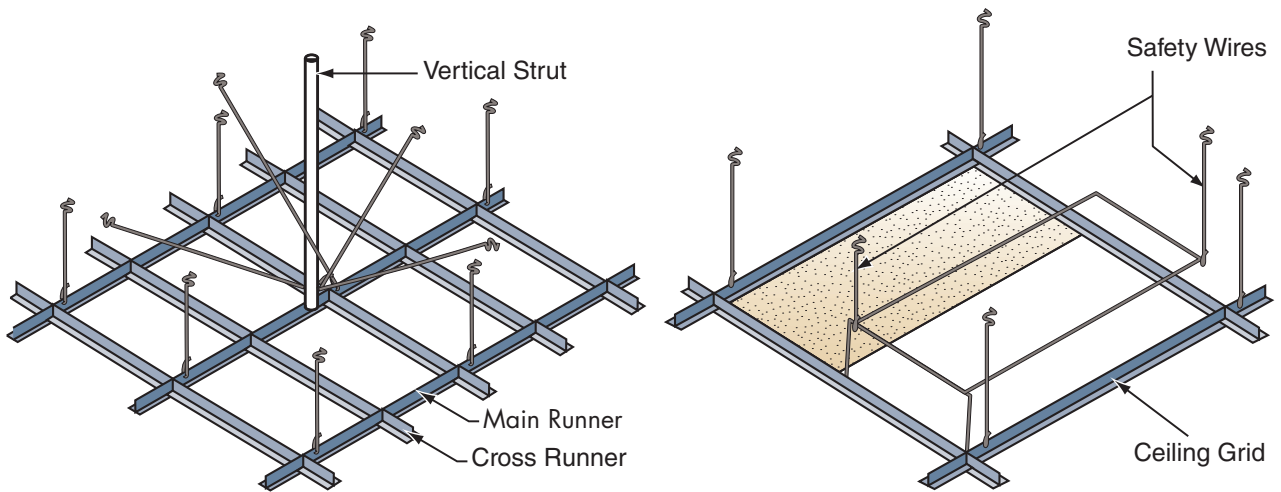

Figure 4-30: Suspended ceiling and light fixture bracing and support



Figure 4-31:  
Bracing tall shelving to the structure

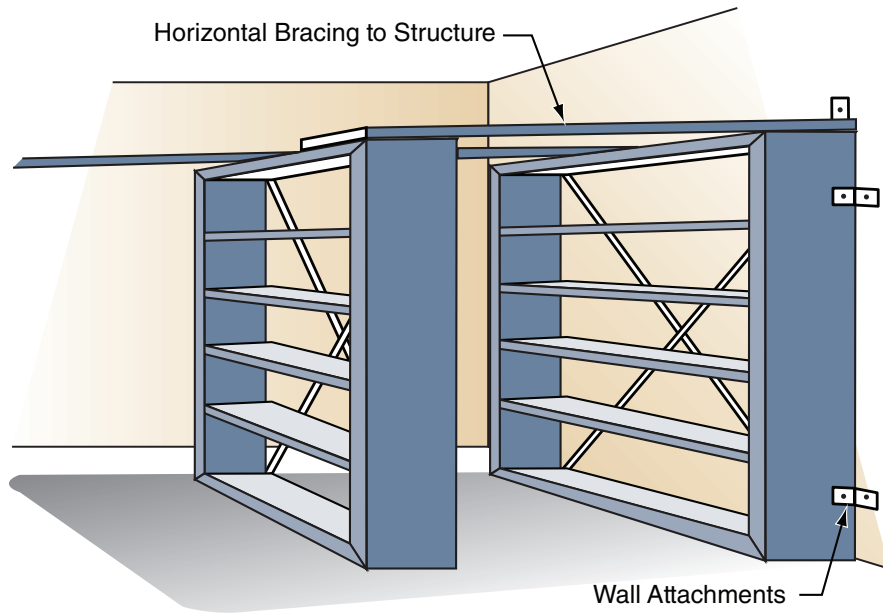

Figure 4-32:  
Connection of nonstructural masonry wall to structure to permit independent movement

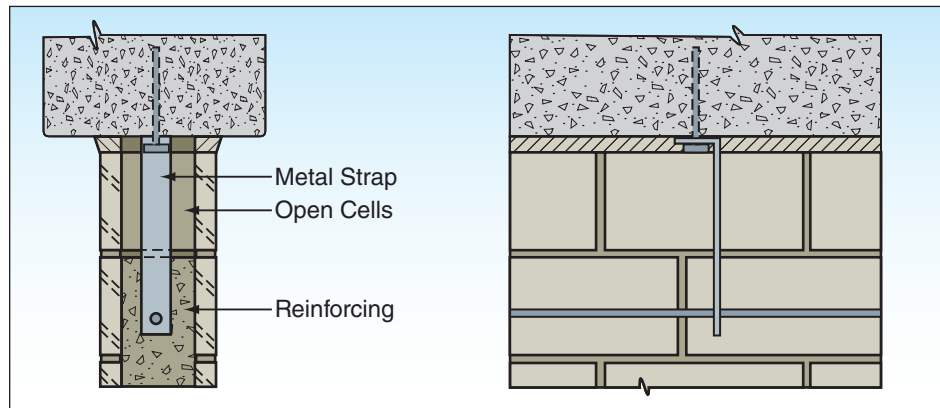
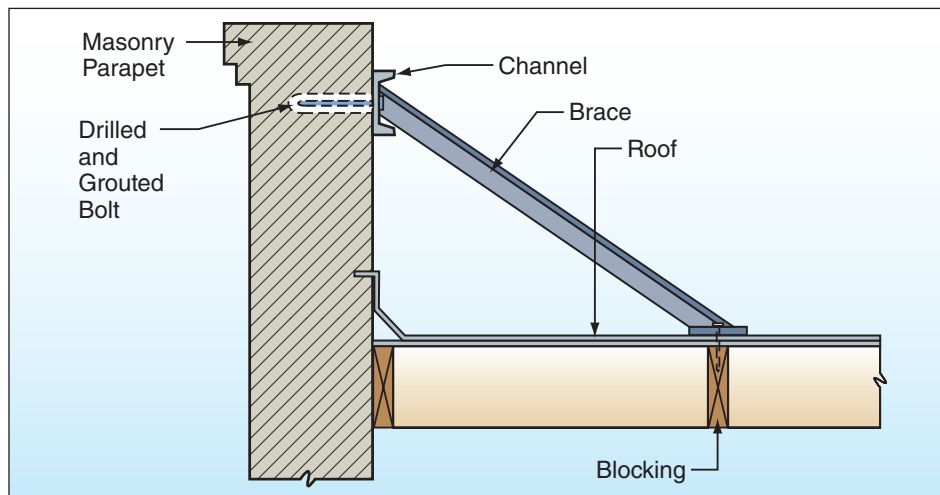

Figure 4-33:  
Bracing for existing unreinforced masonry parapet wall





## 4.6.2 Risk Reduction for Existing Schools

**Procedures and Design Strategies.** Additions to an existing school must meet all of the code requirements for a new building. Currently, no seismic codes apply to the retrofit of existing schools. Typically, the standards to be applied are derived from the code for new buildings and negotiated with the applicable building department. Bringing an existing structure into full compliance with a current code is difficult and in some cases impossible, so some compromises have to be made; however, there is no general agreement on how to apply the code for new buildings to the retrofit design of existing ones.

Reducing the seismic risk for an existing building requires the same general design principles as those necessary for a new building, but the architect and engineer are faced with existing structural and nonstructural systems and materials that may be far from ideal.

The process should begin with an evaluation procedure such as those outlined in Section 4.5. If the evaluation results in a decision to retrofit an existing school, the school district can use ASCE 41 to select seismic protection criteria. ASCE 41 supersedes FEMA 356, *Prestandard and Commentary for the Seismic Rehabilitation of Buildings* (2000b), and FEMA 273, *NEHRP Guidelines for the Seismic Rehabilitation of Buildings* (1997b) and FEMA 274, *NEHRP Commentary on the Guidelines for the Seismic Rehabilitation of Buildings* (1997a), and provides the latest generation of performance-based seismic rehabilitation methodology.

ASCE 41 provides methods and design criteria to achieve several different levels and ranges of seismic performance (unlike a conventional code that implies, but does not define, a single performance level). “Seismic performance” refers to the nature and extent of damage that the building exhibits as a result of an earthquake. ASCE 41 provides a thorough and systematic approach to performance-based seismic design to achieve an acceptable level of risk based on stakeholders needs.

The performance-based design approach outlined in ASCE 41 provides uniform protection criteria for the retrofit of existing buildings to attain a wide range of performance levels for earthquakes of varying severities and probabilities of occurrence. To start, school districts select specific performance goals as a basis for design, and then evaluate the design requirements, including complexity and cost, to meet those goals.

Typical design strategies for improving the protection of an existing school include (see Figure 4-34):

- Modifying and improving local components or materials, such as beam/column connections. This involves retrofitting connections and strengthening structural members by reinforcing or replacing them with new components.
- Removing or reducing configuration irregularities. This involves providing seismic separations in irregular configurations or adding shear walls or bracing to reduce torsional effects, thereby strengthening and/or stiffening the entire structural system. This is a major retrofit that involves adding bracing or shear walls, replacing many structural members.
- Reducing the mass of the building (to reduce forces). This involves changing the location of heavy items (e.g., bookcases) within the building, but would not apply to a one-story building, except where a tile or slate roof covering might be replaced with a lightweight material.

**Retrofit Methods.** Seismic (base) isolation (to reduce force on the building superstructure) is a technique that has been successfully used in the retrofit of large buildings, but it is not generally appropriate to the scale and nature of school buildings unless the school building is considered a historical building. A newer technique is passive energy dissipation, the insertion of supplemental energy devices (to reduce movement), which might be applicable to certain types of school structures (e.g., large gymnasiums, multiuse buildings, or auditoriums). Seismic retrofit at any large scale is expensive, both in design and construction, because of the more complex analyses that must be conducted and the construction constraints that must be overcome. In addition, closure of a school for an extended period (beyond that of the normal summer break) is usually unacceptable. Although rare, some major seismic retrofit projects have been completed, primarily with the goal of saving a building that is not only a place of learning, but a historic community resource. The retrofitting of the B.F. Day School in Seattle is one such project (see Figures 4-35 and 4-36).

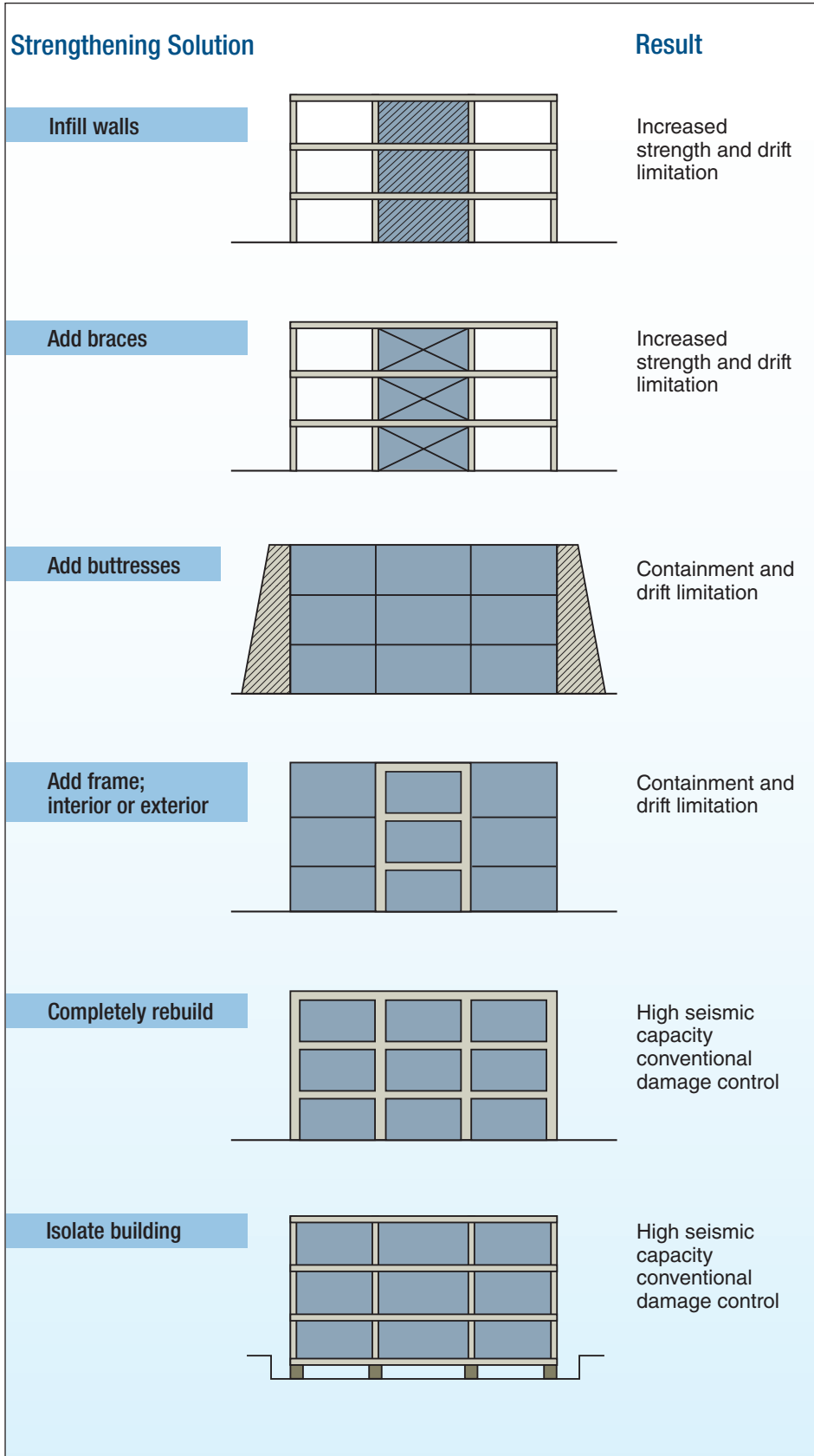

**Figure 4-34:**  
Design strategies for seismic retrofit of existing buildings

SOURCE: *BUILDINGS AT RISK: SEISMIC DESIGN BASICS FOR PRACTICING ARCHITECTS*, AIA/ACSA COUNCIL ON ARCHITECTURAL RESEARCH, WASHINGTON, DC, 1994, ERIC ELSESSER

Figure 4-35:

### Retrofit of B.F. Day Elementary School, Seattle, WA

SOURCE:  
EARTHQUAKE  
ENGINEERING  
RESEARCH  
INSTITUTE,  
OAKLAND, CA; B.F.  
DAY ELEMENTARY  
SCHOOL, SEATTLE,  
TODD W. PERBIX  
AND LINDA L.  
NOSON, 1996



Figure 4-36:  
Sections  
and plans of  
the B.F. Day  
School: existing  
at bottom,  
retrofitted at  
top. Note that  
the retrofit has  
also opened up  
the basement  
and first floor  
to provide large  
spaces suitable  
for today's  
educational  
needs.

SOURCE:  
EARTHQUAKE  
ENGINEERING  
RESEARCH  
INSTITUTE,  
OAKLAND, CA; B.F.  
DAY ELEMENTARY  
SCHOOL, SEATTLE,  
TODD W. PERBIX  
AND LINDA L.  
NOSON, 1996

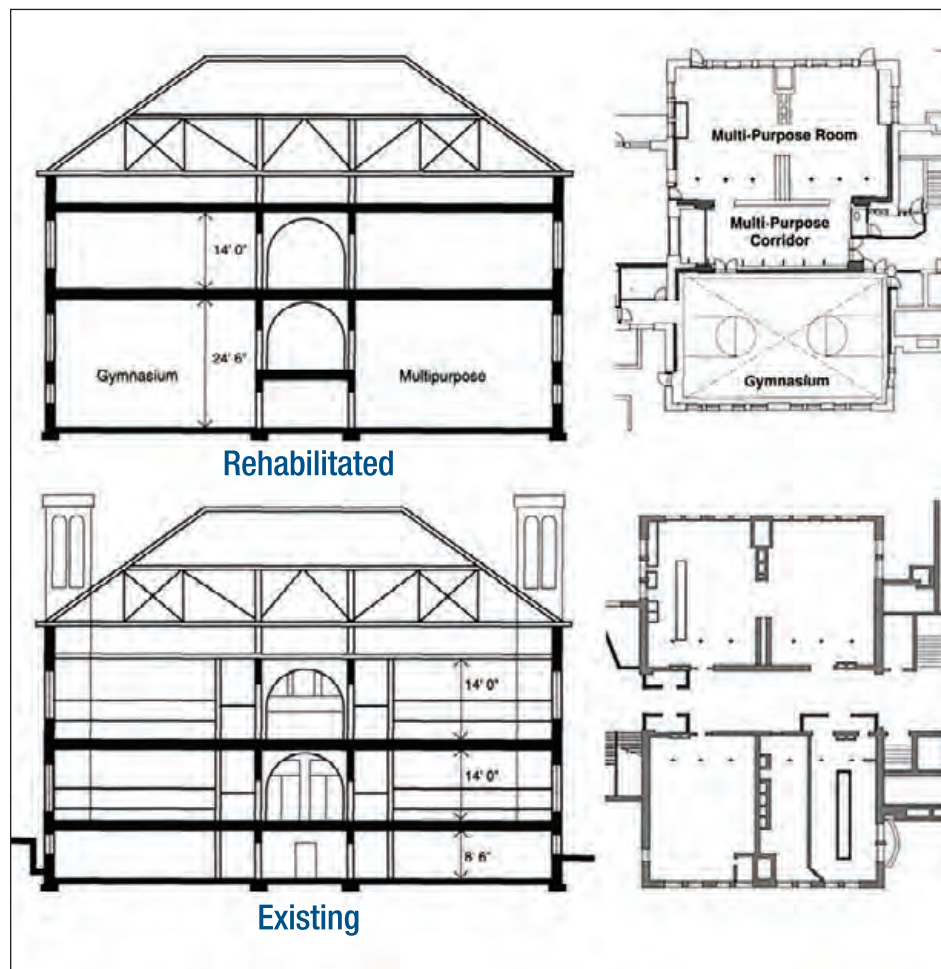

**Incremental Seismic Rehabilitation.** An approach that greatly improves the feasibility of retrofitting a school is “Incremental Seismic Rehabilitation.” The principles of this process are described below. A full description is presented in FEMA 395, *Incremental Seismic Rehabilitation of School Buildings (K-12)* (2003c).

Whereas extensive single-stage seismic retrofitting of an existing school represents a significant cost, retrofit tasks can be divided into increments and integrated into normal repairs and capital improvement projects. Implementation of incremental seismic retrofit involves assessing the buildings, establishing retrofit priorities, and planning integration with other projects. Integration reduces the cost of the seismic work by sharing engineering design costs and some aspects of construction costs. An “integration opportunity” occurs when a seismic retrofit measure can be paired with other repair or replacement tasks or categories. Integration opportunities are a key consideration in determining the sequence of retrofit tasks.

School districts often categorize maintenance and capital improvement projects in the following eight categories:

- Reroofing
- Exterior wall and window replacement
- Fire and life safety improvements
- Modernization/remodeling/new technology accommodation
- Under floor and basement maintenance and repair
- Energy conservation/weatherizing/air-conditioning
- Hazardous materials abatement
- Accessibility improvements

FEMA 395 provides five matrices that show possible combinations of seismic improvement measures with typical work categories. Table 4-3 represents a typical matrix from FEMA 395 and shows possible seismic improvements relating to roof maintenance and repair.

Table 4-3: Roofing maintenance and repair/re-roofing

Rank*	Level of Seismicity			Building Structural Element	Structural Subsystem	Seismic Performance Improvement	Wood	Masonry <sup>1</sup>		Concrete		Steel	
	L	M	H				Unreinforced Masonry	Reinforced Masonry	Wood Diaphragm	Concrete Diaphragm	Wood Diaphragm	Concrete Diaphragm	
<b>Nonstructural</b>													
1	✓	✓	✓	n/a	n/a	Bracing of Parapets, Gables, Ornamentation, and Appendages		■		■	■	■	■
2	✓	✓	✓	n/a	n/a	Anchorage of Canopies at Exits	■	■	■	■	■	■	■
3		✓	✓	n/a	n/a	Bracing or Removal of Chimneys	■	■	■	■	■	■	■
10		✓	✓	n/a	n/a	Anchorage and Detailing of Rooftop Equipment	■	■	■	■	■	■	■
<b>Structural</b>													
n/a		✓	✓	All Elements		Load Path and Collectors	□	□	□	□	□	□	□
n/a		✓	✓	Horizontal Elements	Diaphragms	Attachment and Strengthening at Boundaries	■	■	■	■	□	■	□
n/a		✓	✓	Horizontal Elements	Diaphragms	Strength/Stiffness	■	■	■	■	□	■	□
n/a		✓	✓	Horizontal Elements	Diaphragms	Strengthening at Openings	□	□	□	□		□	
n/a		✓	✓	Horizontal Elements	Diaphragms	Strengthening at Re-entrant Corners	□	□	□	□	□	□	□
n/a		✓	✓	Horizontal Elements	Diaphragms	Topping Slab for Precast Concrete		□	□		□		□
n/a	✓	✓	✓	Vertical Elements	Load Path	Lateral Resisting System to Diaphragm Connection		■	■	■	○	■	○
n/a	✓	✓	✓	Vertical Elements		Out-of-Plane Anchorage of Concrete or Masonry Wall		■	■	■	□	■	□

\* Nonstructural improvements are ranked on the basis of engineering judgment of their relative impact on improving life safety in schools.

Structural improvements are not ranked, but are organized by structural element and subsystem.

- Work that may be included in the building rehabilitation/maintenance/repair project using little or no engineering.
- Work requiring detailed engineering design to be included in the project.
- Work requiring detailed engineering design and evaluation of sequencing requirements. Work could redistribute loads, overstressing some elements.

Note 1: Masonry buildings with a concrete roof deck should use the concrete building, concrete diaphragm for integration opportunities.

n/a = Not Applicable.



Incremental seismic retrofit is an effective, affordable, and non-disruptive strategy to mitigate seismic risk. At the lower levels of protection, some effective construction measures (e.g., bracing nonstructural bookcases and filing cabinets, and anchoring key desktop equipment such as computers) can be implemented by school district maintenance personnel. As a last resort in cases of extreme risk and badly antiquated school buildings, demolition is the only solution.

## 4.7 The School as a Post-Earthquake Shelter

In the aftermath of any damaging earthquake, there is an immediate need of shelter for people who have been displaced from their homes. In earthquake-prone regions, school sites are often used to provide immediate shelter (on the day or night of the earthquake). Schools are conveniently located in every community, with easy and known access to the local population that they serve. They also have suitable spaces (e.g., gymnasiums or multiuse rooms) in which large numbers of people can be accommodated for a few days. Food service is often available, as is ample space for assembly, processing, and delivery of goods and equipment. Because schools are public property, the costs using the facilities for a few weeks are minimal. Also, particularly in California, where schools are subject to the Field Act, schools are well constructed and among the most likely of all the community's buildings to survive intact and in a usable condition.

No specific design decisions are necessary for this use, nor is it necessary to stockpile emergency supplies. The exact circumstances of the event and the number and types of people to be accommodated will determine the supplies that are necessary. Experience has shown that local and even regional manufacturers and suppliers are very effective in providing services after an event. Following the 1983 Coalinga earthquake, temporary shelter was provided in the high school gymnasium. A regional beer canning plant substituted drinking water for beer for a few shifts and rapidly delivered the chilled cans to the site.

The school district and the local emergency services agency should plan for an earthquake event. This includes determining what spaces will be available and how many people can be accommodated, signing a pre-contract with a local engineer or architect for immediate post-earthquake inspection to determine safety, examining strategies for continued operation in the event some spaces are occupied by refugees, and determining a means for providing food and sanitary supplies.

Possible use of school buildings as a safe haven for the community in the event of chemical, biological, radiological, or explosive attack involves

complex design and construction issues. This use of school property is discussed in FEMA 428, *Primer to Design Safe School Projects in Case of Terrorist Attacks*, Chapter 6 (2003b), and FEMA 453, *Design Guidance for Shelters and Safe Rooms* (2006).

## 4.8 References and Sources of Additional Information

American Society of Civil Engineers (ASCE), 2003. *Seismic Evaluation of Existing Buildings*, ASCE 31-03, Structural Engineering Institute, Reston, VA.

ASCE, 2005. *Minimum Design Loads for Buildings and Other Structures*, ASCE 7-05, Structural Engineering Institute, Reston, VA.

ASCE, 2007. *Seismic Rehabilitation of Existing Buildings*, ASCE 41-07, Structural Engineering Institute, Reston, VA.

ASCE, 2010. *Minimum Design Loads for Buildings and Other Structures*, ASCE 7-10, Structural Engineering Institute, Reston, VA.

Applied Technology Council (ATC), 1978. *Tentative Provisions for the Development of Seismic Regulations for Buildings*, ATC-3-06, Washington, DC, June 1978.

ATC, 1995. ATC 20, *Postearthquake Building Safety Evaluation Procedures*, Washington, DC.

Arnold, Chris, and Tony Alexander, 2001. *BSSC: Presentations to the Architectural Community*.

California Emergency Management Agency, 2003. *Guide and Checklist for Nonstructural Earthquake Hazards in California Schools*. Governor's Office of Emergency Services, Mather, CA, 56 pages.

California Seismic Safety Commission (CSSC), 1995. *Northridge Earthquake: Turning Loss to Gain*, Report No. CSSC 95-01, Sacramento, CA.

Federal Emergency Management Agency (FEMA), 1992. *NEHRP Handbook for the Seismic Evaluation of Existing Buildings*, FEMA 178, Building Seismic Safety Council, Washington, DC.

FEMA, 1994. *Reducing the Risks of Nonstructural Earthquake Damage: A Practical Guide*, FEMA 74, Wiss, Janney, Elstner Associates, Inc., Washington, DC.

FEMA, 1997a. *NEHRP Commentary on the Guidelines for the Seismic Rehabilitation of Buildings*, FEMA 274, prepared by the Building Seismic Safety Council and the Applied Technology Council for FEMA, Washington, DC.

FEMA, 1997b. *NEHRP Guidelines for the Seismic Rehabilitation of Buildings*, FEMA 273, Building Seismic Safety Council, Washington, DC.

FEMA, 1998. *Handbook for the Seismic Evaluation of Existing Buildings*, FEMA 310, Washington, DC.

FEMA, 2000a. *NEHRP Recommended Provisions for Seismic Regulation for New Buildings*, 2000 Edition, 2 volumes and maps (FEMA 368) and commentary (FEMA 369).

FEMA, 2000b. *Prestandard and Commentary for the Seismic Rehabilitation of Buildings*, FEMA 356, prepared by the American Society of Civil Engineers for FEMA, Washington, DC.

FEMA, 2002a. *Handbook for the Seismic Evaluation of Existing Buildings*, FEMA 310, Washington, DC.

FEMA, 2002b. *Rapid Visual Screening of Buildings for Potential Seismic Hazards: A Handbook*, Second Edition, FEMA 154, prepared by the Applied Technology Council for FEMA, Washington, DC.

FEMA, 2003a. *The NEHRP Recommended Provisions for Seismic Regulation for New Buildings*, 2003 Edition, 2 volumes and maps (FEMA 450) and commentary (FEMA 451).

FEMA, 2003b. *Primer to Design Safe School Projects in Case of Terrorist Attacks*, FEMA 428, Washington, DC.

FEMA, 2003c. *Incremental Seismic Rehabilitation of School Buildings (K-12)*, FEMA 395, Virginia Polytechnic Institute/Building Technology Incorporated, Silver Spring, MD/Melvyn Green & Associates, Inc., Torrance, CA, Washington, DC.

FEMA, 2006. *Design Guidance for Shelters and Safe Rooms*, FEMA 453, Washington, DC.

Heinz Center, 2002. *Human Links to Coastal Disasters*, H. John Heinz III Center for Science, Economics, and the Environment, Washington, DC, 2002.

International Code Council (ICC), 2000. International Building Code 2000, Country Club Hills, IL.

ICC, 2009. International Building Code 2009, Country Club Hills, IL.

U.S. Geological Survey (USGS), 2010. Earthquake Hazards Program Web site, <http://earthquake.usgs.gov/>.

## 4.9 Glossary of Earthquake Terms

**Acceleration.** Rate of change of velocity with time.

**Amplification.** A relative increase in ground motion between one type of soil and another or an increase in building response as a result of resonance.

**Amplitude.** Maximum deviation from mean of the center line of a wave.

**Architectural Components.** Components such as exterior cladding, ceilings, partitions, and finishes.

**Building.** Any structure that could be used for the shelter of human occupants.

**Component (also Element).** Part of an architectural, structural, electrical, or mechanical system.

**Configuration.** The size, shape, and geometrical proportions of a building.

**Connection.** A means by which different materials or components are joined to each other.

**Damage.** Any physical destruction caused by earthquakes.

**Deflection.** The state of being turned aside from a straight line, generally used in the horizontal sense; see also “Drift.”

**Design Earthquake.** In the International Building Code (IBC), the earthquake that produces ground motions at a site that are two-thirds those of the “Maximum Considered Earthquake.”

**Design Ground Motion.** See “Design Earthquake.”

**Diaphragm.** A horizontal or nearly horizontal structural element designed to transmit lateral forces to the vertical elements of the seismic force resisting system.

**Drift.** Vertical deflection of a building or structure caused by lateral forces; see also “Story Drift.”

**Ductility.** Property of some materials, such as steel, to distort when subjected to forces while still retaining considerable strength.

**Earthquake.** A sudden motion or vibration in the earth caused by the abrupt release of energy in the earth’s lithosphere.

**Effective Peak Acceleration and Effective Peak Velocity Related Acceleration.** Coefficients shown on maps in the IBC for determining prescribed seismic forces.

**Elastic.** Capable of recovering size and shape after deformation.

**Epicenter.** A point on the earth’s surface that is directly above the focus of an earthquake.

**Exceedance Probability.** The probability that a specified level of ground motion or specified social or economic consequences of earthquakes will be exceeded at a site or in a region during a specified exposure time.

**Exposure.** The potential economic loss to all or certain subsets of the built environment as a result of one or more earthquakes in an area; this term usually refers to the insured value of structures carried by one or more insurers.

**Fault.** A fracture in the earth’s crust accompanied by displacement of one side of the fracture with respect to the other in a direction parallel to the fracture.

**Focus.** The location of a fault break where an earthquake originates; also termed “Hypocenter.”

**Force.** Agency or influence that tries to deform an object or overcome its resistance to motion.

**Frame, Braced.** Diagonal members connecting components of a structural frame to resist lateral forces.

**Frame, Space.** A structural system composed of interconnected members, other than bearing walls, that is capable of supporting vertical loads and that also may provide resistance to seismic forces.

**Frame System, Building.** A structural system with an essentially complete space frame providing support for vertical loads; seismic forces are resisted by shear walls or braced frames.

**Frame System, Moment.** A frame in which members and joints are capable of resisting lateral forces by flexure as well as along the axis of the members; varying levels of resistance are provided by ordinary, intermediate, and special moment frames as defined in the IBC with special frames providing the most resistance.

**“g”.** The acceleration due to gravity or 32 feet per second.

**Ground Failure.** Physical changes to the ground surface produced by an earthquake, such as lateral spreading, landslides, or liquefaction.

**Hypocenter.** See “Focus.”

**Intensity.** The apparent effect that an earthquake produces at a given location; in the United States, intensity generally is measured by the modified Mercalli intensity scale.

**Irregular.** Deviation of a building configuration from a simple symmetrical shape.

**Joint.** Location of connections between structural or nonstructural members and components.

**Liquefaction.** The conversion of a solid into a liquid by heat, pressure, or violent motion; sometimes occurs to the ground in earthquakes.

**Loss.** Any adverse economic or social consequences caused by earthquakes.

**Mass.** A constant quantity or aggregate of matter; the inertia or sluggishness that an object, when frictionlessly mounted, exhibits in response to any effort made to start it or stop it or to change in any way its state of motion.

**Maximum Considered Earthquake Ground Motion.** The most severe earthquake effects considered in the IBC. These are represented by the mapped spectral response accelerations at short and long periods,



obtained from maps in the IBC, adjusted for Site Class effects using site coefficients.

**Mercalli Scale (or Index).** A measure of earthquake intensity named after Giuseppe Mercalli, an Italian priest and geologist.

**Nonbuilding Structure.** A structure, other than a building, designed and constructed in a manner similar to buildings and having a basic lateral and vertical seismic-force-resisting system conforming to a type included in Chapter 14 of the IBC.

**Occupancy Importance Factor.** A factor, between 1.0–1.5, assigned to each structure according to its Seismic Occupancy Category.

**Partition.** See “Wall, Nonbearing.”

**Period.** The elapsed time (generally in seconds) of a single cycle of a vibratory motion or oscillation; the inverse of frequency.

**P-Wave.** The primary or fastest waves traveling away from a fault rupture through the earth’s crust and consisting of a series of compressions and dilations of the ground material.

**Quality Assurance Plan.** A detailed written procedure that establishes the systems and components subject to special inspection and testing.

**Recurrence Interval.** See “Return Period.”

**Resonance.** The amplification of a vibratory motion occurring when the period of an impulse or periodic stimulus coincides with the period of the oscillating body.

**Return Period.** The time period in years in which the probability is 63 percent that an earthquake of a certain magnitude will recur.

**Richter Magnitude (or Scale).** A logarithmic scale expressing the magnitude of a seismic (earthquake) disturbance in terms of the maximum amplitude of the seismic waves at a standard distance from their focus; named after its creator, the American seismologist Charles R. Richter.

**Rigidity.** Relative stiffness of a structure or element; in numerical terms, equal to the reciprocal of displacement caused by unit force.

**Seismic.** Of, subject to, or caused by an earthquake or an earth vibration.

**Seismic Event.** The abrupt release of energy in the earth’s lithosphere causing an earth vibration; an earthquake.

**Seismic Force Resisting System.** The part of the structural system that is designed to provide required resistance to prescribed seismic forces.

**Seismic Forces.** The actual forces created by earthquake motion; assumed forces prescribed in the IBC that are used in the seismic design of a building and its components.

**Seismic Hazard.** Any physical phenomenon such as ground shaking or ground failure associated with an earthquake that may produce adverse effects on the built environment and human activities; also the probability of earthquakes of defined magnitude or intensity affecting a given location.

**Seismic Occupancy Category.** A classification assigned to a structure based on its occupancy and use as defined in the IBC.

**Seismic Risk.** The probability that the social or economic consequences of an earthquake will equal or exceed specified values at a site during a specified exposure time; in general, seismic risk is vulnerability multiplied by the seismic hazard.

**Seismic Waves.** See “Waves, Seismic.”

**Seismic Zone.** Generally, areas defined on a map within which seismic design requirements are constant; in the IBC, seismic zones are defined both by contour lines and county boundaries.

**Shear.** A force that acts by attempting to cause the fibers or planes of an object to slide over one another.

**Shear Wall.** See “Wall, Shear.”

**Speed.** Rate of change of distance traveled with time irrespective of direction.

**Stiffness.** Resistance to deflection or drift of a structural component or system.

**Story Drift.** Vertical deflection of a single story of a building caused by lateral forces.

**Strain.** Deformation of a material per unit of the original dimension.

**Strength.** The capability of a material or structural member to resist or withstand applied forces.

**Stress.** Applied load per unit area or internal resistance within a material that opposes a force's attempts to deform it.

**S-Wave.** Shear or secondary wave produced essentially by the shearing or tearing motions of earthquakes at right angles to the direction of wave propagation.

**System.** An assembly of components or elements, such as a structural system, designed to perform a specific function.

**Torsion.** The twisting of a structural member about its longitudinal axis.

**Velocity.** Rate of change of distance traveled with time in a given direction; in earthquakes, it usually refers to seismic waves and is expressed in inches or centimeters per second.

**Vulnerability.** The degree of loss to a given element at risk, or set of such elements, resulting from an earthquake of a given intensity or magnitude; expressed in a scale ranging from no damage to total loss; a measure of the probability of damage to a structure or a number of structures.

**Wall, Bearing.** An interior or exterior wall providing support for vertical loads.

**Wall, Nonbearing.** An interior or exterior wall that does not provide support for vertical loads other than its own weight as permitted by the building code; see also "Partition."

**Wall, Shear.** A wall, bearing or nonbearing, designed to resist lateral forces parallel to the plane of the wall.

**Wall System, Bearing.** A structural system with bearing walls providing support for all or major portions of the vertical loads; seismic resistance may be provided by shear walls or braced frames.

**Waves, Seismic.** Vibrations in the form of waves created in the earth by an earthquake.

**Weight.** Name given to the mutual gravitational force between the earth and an object under consideration; varies depending on location of the object at the surface of the earth.





## Design Guide

for Improving School Safety  
in Earthquakes, Floods, and High Winds

# 5 Making Schools Safe From Flooding

## 5.1 General Design Considerations

**T**his chapter introduces the physical nature and mechanics of floods and explains how flood probabilities are determined and how flood hazard areas are identified. It describes the types of flood damage that can result when schools are located in flood hazard areas and are affected by flooding. A series of requirements and best practices are introduced that school districts, facility planners, and designers should consider for reducing the risks from flooding to new schools and to existing school campuses that are located in floodprone areas.

This chapter demonstrates why avoidance of flood hazard areas is the most effective way to minimize the life-safety risk to students, staff, and the citizens who rely on these facilities, as well as to minimize the potential for damage to buildings and other elements of schools and campuses. When an existing school building is exposed to flooding, or a new school building is proposed to be located in a flood hazard area, steps should be taken to minimize the risks. A well-planned, designed,

When new schools are being planned and constructed, and a site with a flood hazard must be used, it is important that:

- the school be placed on the portion of the site that is least vulnerable to the identified flood hazard
- the highest level of care be used for the design and construction of the school (i.e., the most stringent application of ASCE7, ASCE 24, and the local floodplain ordinance)

constructed, and maintained school should be able to withstand damage and remain functional after a flooding event, even one of low probability. ASCE 24, *Flood Resistant Design and Construction*, provides “minimum requirements for flood-resistant design and construction of structures” (2005). Design professionals should be familiar with this standard and exercise an appropriate level of care in any construction of school buildings in flood hazard areas.

### 5.1.1 The Nature of Flooding

Flooding is the most common natural hazard in the United States, affecting more than 21,000 local jurisdictions and representing more than 70 percent of Presidential disaster declarations. Several studies have estimated that 7 to 10 percent of the Nation’s land area is subject to flooding. Some communities have very little flood risk; others lie entirely within the floodplain.

Flooding is a natural process that may occur in a variety of forms: long-duration flooding along rivers that drain large watersheds; flash floods that send a devastating wall of water down a mountain canyon; and coastal flooding that accompanies high tides and onshore winds, hurricanes, and nor’easters. When this natural process does not affect human activity, flooding is not a problem. In fact, many species of plants and animals that live adjacent to bodies of water are adapted to a regimen of periodic flooding.

Flooding is only a problem when human development is located in areas prone to flooding. Such development exposes people to potentially life-threatening situations and makes property vulnerable to serious damage or destruction. It also can disrupt the natural surface flow, redirecting water onto lands not normally subject to flooding.

Flooding along waterways normally occurs as a result of excessive rainfall or snowmelt that exceeds the capacity of channels. Flooding along shorelines is usually a result of coastal storms that generate storm surges or waves above normal tidal fluctuations. Factors that can affect the frequency and severity of flooding and the resulting damage include:

- Channel obstructions caused by fallen trees, accumulated debris, and ice jams
- Channel obstructions caused by road and rail crossings where the bridge or culvert openings are insufficient to convey floodwaters



- Erosion of shorelines and stream banks, often with episodic collapse of large areas of land
- Deposition of sediment that settles out of floodwaters or is carried inland by wave action
- Increased upland development of impervious surfaces and manmade drainage improvements that increase rainfall-runoff volumes
- Land subsidence, which increases flood depths
- Failure of dams (resulting from seismic activity, lack of maintenance, flows that exceed the design, or destructive acts), which may suddenly and unexpectedly release large volumes of water
- Failure of levees (associated with flows that exceed the design, weakening by seismic activity, lack of maintenance, or destructive acts), which may result in sudden flooding of areas behind levees
- Failure of seawalls, revetments, bulkheads, or similar coastal structures, which can lead to rapid erosion and increased flooding and wave damage during storms

Each type of flooding has characteristics that represent important aspects of the hazard. These characteristics should be considered in the selection of school sites, the design of new school buildings and athletic facilities, and the expansion or rehabilitation of existing floodprone schools.

**Riverine flooding** results from the accumulation of runoff from rainfall or snowmelt, such that the volume of water exceeds the capacity of waterway channels and spreads out over the adjacent land. Riverine flooding flows downstream under the force of gravity. Its depth, duration, and velocity are functions of many factors, including watershed size and slope, degree of upstream development, soil types and nature of vegetation, topography, and characteristics of storms (or depth of snowpack and rate of melting). Figure 5-1 illustrates a cross-section of a generic riverine floodplain.

#### Four Examples of Schools Vulnerable to Flood Hazards

1. Two schools in Gurnee, IL, were damaged by floods in 1986. The school district's actual costs were over \$1.6 million to repair and replace the facilities, supplies, and materials. Not included in this figure are the costs for transportation and rental, and disruption of the school year for children who, for several months, attended school in a vacant department store 4 miles away. For an additional 2 years of renovation and reconstruction, the children attended school in another community 8 miles away. One school was later rebuilt as a flood-protected facility for a cost of \$17 million, all of which was paid by local taxpayers.
2. In April 2003, a dry floodproofed private school in Jackson, MS, was soaked when a sudden downpour dumped 9 inches of rain on the area. Because the event occurred in the pre-dawn hours when no one was on site to install the floodproofing measures (e.g., water-tight doors and special seals), water entered the building, causing damage to carpets, walls, furniture, and equipment.
3. In 1989, Hurricane Hugo vividly revealed the importance of knowing whether schools are prone to flooding. The local emergency manager's records identified the McClellanville, SC, school as an approved hurricane shelter. Unfortunately, that designation was based on the erroneous information about the elevation of the building. When storm surge flooding inundated the school, people had to break through the ceiling and lift everyone up to the attic.
4. Flooding in the spring of 2001 tested flood protection for the Oak Grove Lutheran High School in Fargo, ND (see Figure 5-29). Prompted by the failure of temporary earth and sandbag dikes during the 1997 Red River flood of record, which resulted in over \$3.5 million in damage to the school, the city designed and constructed a brick-faced permanent floodwall. Five access points, wide enough for vehicles, were protected with an "invisible" closure that is an integral part of the floodwall. A crew of six installed the closures in less than 2 hours.

Figure 5-1:  
The riverine floodplain

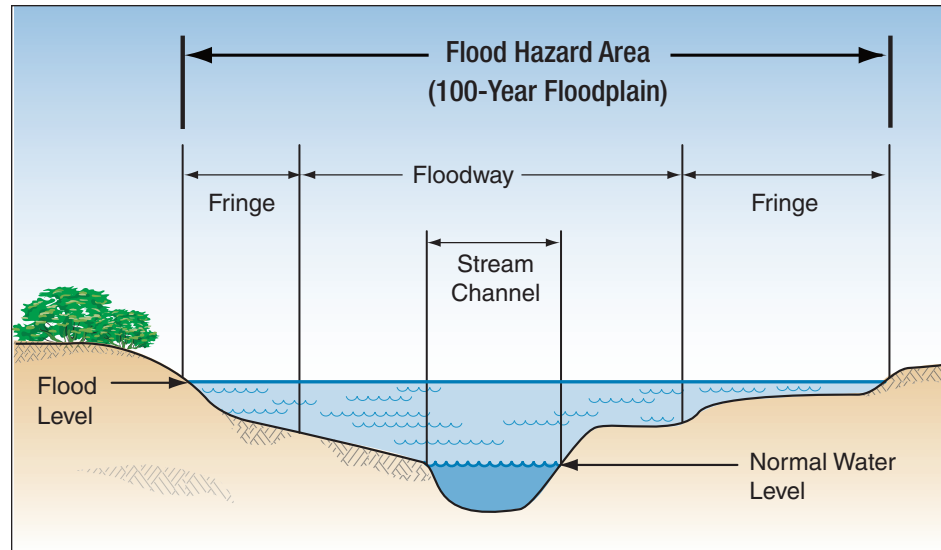

**Coastal flooding** is experienced along the Atlantic, Gulf, and Pacific coasts, and the Great Lakes. Coastal flooding is influenced by storm surges associated with tropical cyclonic weather systems (hurricanes, tropical storms, tropical depressions, typhoons), extratropical systems (nor'easters and other large low-pressure systems), seiches and tsunamis (surges induced by seismic activity). Coastal flooding is characterized by wind-driven waves that also may affect areas along the Great Lakes shorelines; winds blowing across the broad expanses of water generate waves that can rival those experienced along ocean shorelines. Some Great Lakes shorelines experience coastal erosion, in part because the erosion is associated with fluctuations in water levels. Figure 5-2 is a schematic of a generic coastal floodplain.

### 5.1.2 Probability of Occurrence or Frequency

The probability of occurrence, or frequency, is a statement of the likelihood that an event of a certain magnitude will occur in a given period of time. For many decades, floodplain management has been based on the flood that has a 1-percent chance of occurring in any given year, commonly called the “100-year flood.” For certain critical actions, such as planning or constructing schools and evacuation shelters, the basis of risk decisions should be the flood that has a 0.2-percent probability of occurring in any given year, commonly called the “500-year flood.” In most locations, the benefits of added protection to the 500-year level are greater than the added costs.

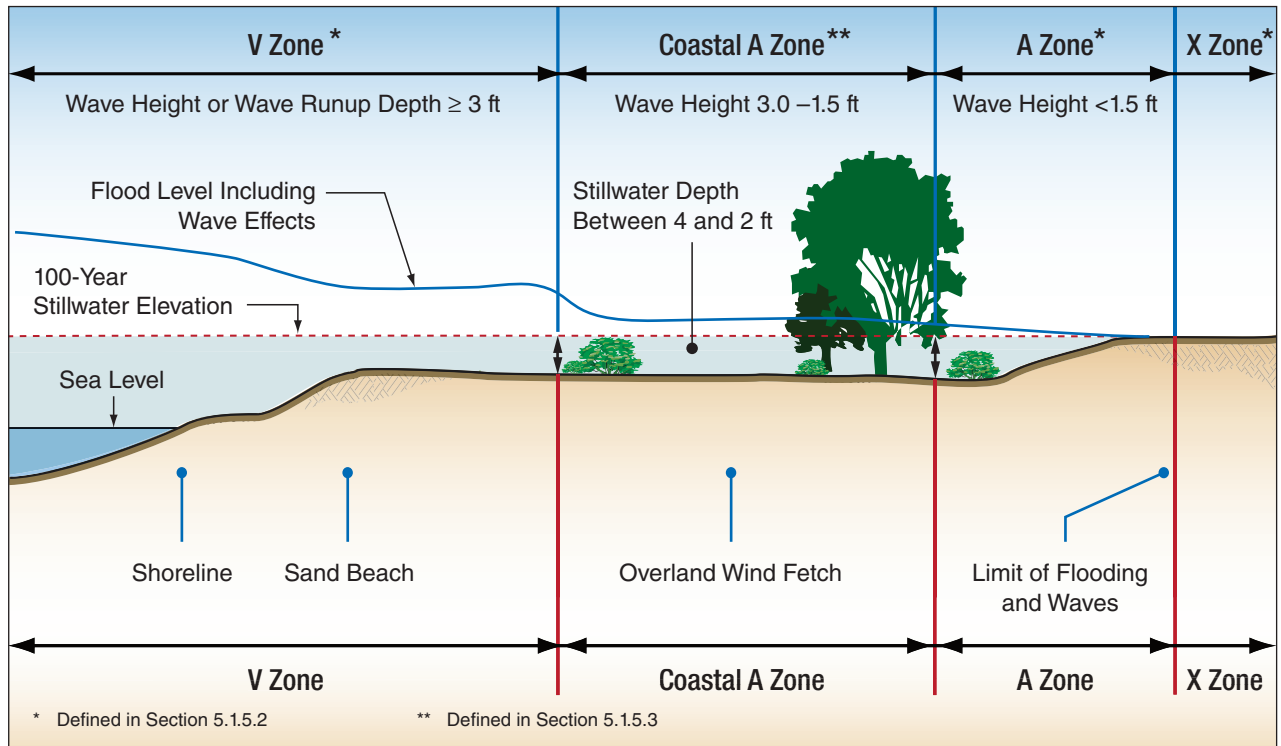

Figure 5-2: The floodplain along an open coast

The term “100-year flood” is often misunderstood because it conveys the impression that a flood of that magnitude will occur only once every 100 years. Actually, the 1-percent-annual-chance flood has one chance in 100 of occurring in any given year. The fact that a 1-percent-annual-chance flood is experienced at a specific location does not alter the probability that a flood of the same or greater magnitude could occur at the same location in the next year, or even multiple times in a single year. As the length of time considered increases, so does the probability that a flood of a specific magnitude or greater will occur. For example, Figure 5-3 illustrates that the probability a 100-year flood will occur is 26 percent during a 30-year period. And during a 70-year period (the potential useful life of many buildings), the probability increases to 50 percent. Similarly, a 500-year flood has a 0.2-percent probability of being equaled or exceeded in any given year, a 6-percent probability of occurrence during a 30-year period, and an 18-percent probability of occurrence during a 70-year period.

The assigned frequency of a flood (e.g., 100-year) is independent of the number of years between actual occurrences. Hurricane Camille hit the Mississippi coast in 1969 with storm surge flooding that far exceeded previous events, and Hurricane Katrina affected much the

same area in 2005. Although just 36 years apart, both storms produced flood levels that were significantly higher than the predicted 100-year flood. Similarly, the Mississippi River flooded large areas in Missouri in 1993 with flooding that exceeded the predicted 100-year flood levels. Just 2 years later, many of the same areas were flooded again.

**Figure 5-3:**  
Probability and  
magnitude

SOURCE: U.S. GEOLOGICAL SURVEY, GUIDELINES FOR DETERMINING FLOOD FLOW FREQUENCY, BULLETIN 17B (APPENDIX D).

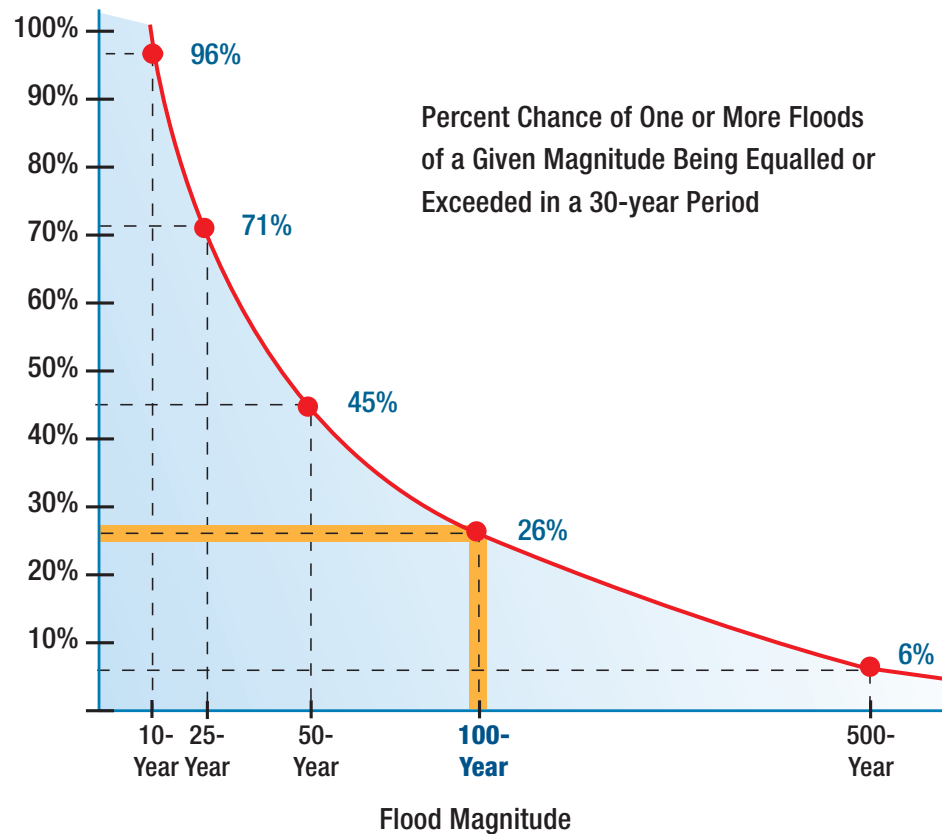

Regardless of the flood selected for design purposes (the “design flood”), the designer must determine specific characteristics associated with that flood. Determining a flood with a specific probability of occurrence is done in a multi-step process that typically involves using computer models available in the public domain. If a sufficiently long record of flood information exists, the design flood may be determined by applying statistical tools to the data.

The term “100-year flood” is often misunderstood because it conveys the impression that a flood of that magnitude will occur only once every 100 years. Actually, it has one chance in 100 of occurring in any given year.

Alternatively, water resource engineers sometimes apply computer models to simulate different rainfall events over watersheds to predict how much water will run off and accumulate in channels. Other computer models are used to characterize the flow of water down the watershed and predict how high the floodwaters will rise.

Flood frequency analyses are performed using historical records, and the results are influenced by the length of the record. Such analyses do not account for recent changes to the land (upland development or subsidence) or future changes (additional development, greater subsidence, or climatic variations).

For coastal areas, both historical storms and simulated storm surge models can be used to predict the probability that floodwaters will rise to a certain level and be accompanied by waves of certain heights. Many coastal storms will produce storm surge flooding that, depending on local topography, may extend inland significantly farther than anticipated for a 1-percent-annual-chance flood. Other factors that influence the severity of hurricane storm surges include the forward speed of the storm, when during the tide cycle the storm comes onshore, and the near-shore bathymetry. Statistically, extreme storm surges occur less frequently than the 1-percent- or 0.2-percent-annual-chance floods, but their consequences can be catastrophic.

School facility planners and designers should research the relationship between flood levels for different frequency events, including extreme events, especially in hurricane-prone communities. The difference in flood levels may be extreme in some situations, depending on local conditions and the source of flooding. In other areas flood levels of lower probability floods might not be much higher than a 1-percent-annual-chance flood.

The National Flood Insurance Program (NFIP) is a Federal program that encourages communities to regulate flood hazard areas and, in return, offers property owners insurance protection against losses from flooding (see Sections 5.1.6.1 and 5.1.6.2). The NFIP uses the 1-percent-annual-chance flood as the basis for flood hazard maps, for setting insurance rates, and for application of regulations in order to minimize future flood damage.

The commentary of ASCE 24 provides additional information on addressing flood risk through the use of flood events other than the 1-percent-annual-chance flood, including local “flood of record” events. Nearly every year, a very low probability flood occurs somewhere in the United States, often with catastrophic consequences. Therefore, use of a lower probability flood (at least the 0.2-percent-annual-chance, or 500-year) for design purposes is strongly recommended (and may be required by some States and local jurisdictions).

ASCE 24 sets forth that a higher level of protection is required for critical facilities, essential facilities, and schools. This higher level of protection considers additional freeboard and designing for a lower probability flood event (e.g., the 0.2-percent-annual-chance flood).”

As noted in Section 5.1.6.3, the 500-year level of protection is required if Federal funds are involved in constructing critical facilities that are vital for emergency response and rapid recovery. This reinforces the importance of protecting both the functionality and financial investment in a school by applying stricter standards than those required for other buildings. Students and the community experience significant and long-term impacts if a damaged school is closed for an extended period of time.

### 5.1.3 Flood Characteristics and Loads

A number of factors associated with riverine and coastal flooding are important in the selection of sites for schools, in site design, and in the determination of flood loads required as part of architectural and engineering design.

**Depth:** The most apparent characteristic of any flood is the depth of the water. Depending on many factors, such as the shape of a river valley or the presence of obstructing bridges, riverine flooding may rise just a few feet or tens of feet above normal levels. The depth of coastal flooding is influenced by such factors as the tidal cycle, the duration of the storm, the elevation of the land, offshore bathymetry, and the presence of waves. Depth is a critical factor in building design because the hydrostatic forces on a vertical surface (such as a foundation wall) are directly related to depth, and because costs associated with protecting buildings from flooding increase with depth. Under certain conditions, hurricanes can produce storm surge flooding that is 20 to 30 feet above mean sea level or, in extreme cases along the Gulf Coast, 35 feet or higher above mean sea level.

**Duration:** Duration is the measure of how long the water remains above normal levels. The duration of riverine flooding is primarily a function of watershed size and the longitudinal slope of the valley (which influences how fast water drains away). Small watersheds are more likely to be “flashy,” a characteristic that refers to the rapidity with which floodwaters rise and fall. Areas adjacent to large rivers may be flooded for weeks or months. Most coastal flooding is influenced by the normal tidal cycle, as well as how fast coastal storms move through the region. Areas subject to coastal flooding can experience long periods of flooding where drainage is poor or slow as a result of topography or the presence of flood control structures. For example, water may be trapped in depressions in the land or behind a floodwall or levee with inadequate drainage. More commonly, coastal flooding is of shorter duration, on the order of 12 to 24 hours, especially if storms move rapidly. Flooding of large lakes, including those behind dams, can be of very long duration because the large volume of



water takes longer to drain. For building design, duration is important because it affects access, building usability, and saturation and stability of soils and building materials. Information about flood duration is sometimes available as part of a flood study or can be developed by a qualified engineer.

Local drainage problems create ponding and local flooding that is often not directly associated with a body of water such as a creek or river. Although such flooding is relatively shallow and not characterized by high velocity flows, considerable damage may result. Areas with poor drainage frequently experience repetitive damage. Some local drainage problems are exacerbated by old or undersized drainage system infrastructure. Flooding caused by drainage problems typically occurs as sheetflow or along waterways with small drainage areas. This type of flooding is generally not mapped or regulated.

**Velocity:** The velocity of floodwaters ranges from extremely high (associated with flash floods or storm surge) to very low or nearly stagnant (in backwater areas and expansive floodplains). Velocity is important in site planning because of the potential for erosion. In structural design, velocity is a factor in determining the hydrodynamic loads and impact loads. Even shallow, high-velocity water can threaten the lives of pedestrians and motorists. Accurate estimates of velocities are difficult to make, although information about mean velocities may be found in some floodplain studies.

**Wave action:** Waves contribute to erosion and scour, and also contribute significantly to design loads on buildings. The magnitude of wave forces can be 10 to more than 100 times greater than wind and other design loads, and thus may control many design parameters. The magnitude of wave forces can be 10 to more than 100 times greater than wind and other design loads, and thus may control many design parameters. Waves must be accounted for in site planning along coastal shorelines, in flood hazard areas that are inland of open coasts, and other areas where waves occur, including areas with sufficient fetch that winds can generate waves (such as lakes and expansive riverine floodplains). Waves on top of storm surges may be as much as 50 percent higher than the stillwater depth (flood depth without waves) of the surge.

**Impacts from debris and ice:** Floating debris and ice contribute to the loads that must be accounted for in structural design. The methods and models used to predict and delineate flood hazard areas do not specifically incorporate the effects of debris. Thus, there are few sources to determine the potential effects of debris impact loads, other than past observations and judgment.

**Erosion and scour:** In coastal areas, erosion refers to the lowering of the ground surface as a result of a flood event, or the gradual recession of a shoreline as a result of long-term coastal processes. Along riverine waterways, erosion refers to undermining of channel banks, lateral movement of the channel, or cutting of new channels. Scour refers to a localized lowering of the ground surface due to the interaction of currents and/or waves with structural elements, such as pilings. Soil characteristics influence an area's susceptibility to scour. Erosion and scour may affect the stability of foundations and earthen-filled areas, and may cause extensive site damage.

### 5.1.3.1 Hydrostatic Loads

Hydrostatic loads occur when water comes into contact with a building or building component, both above and below the ground level. They act as lateral pressure or vertical pressure (buoyancy). Hydrostatic loads on inclined or irregular surfaces may be resolved into lateral and vertical loads based on the surface geometry and the distribution of hydrostatic pressure.

Lateral hydrostatic loads are a direct function of water depth (see Figure 5-4). These loads can cause severe deflection or displacement of buildings or building components if there is a substantial difference in water levels on opposite sides of the component (or inside and outside of the building). Hydrostatic loads are balanced on foundation elements of elevated buildings, such as piers and columns, because the element is surrounded by water. If not oriented parallel to the flow of water, shear-walls may experience hydrostatic loads due to a difference of water depth on either side of the wall. To reduce excessive pressure from standing water, floodplain management requirements in flood zones known as "A zones" call for openings in walls that enclose areas below the flood elevation (see description of continuous perimeter wall foundation in Section 5.3.4 and description of flood zones in Section 5.1.5.2).

Buoyancy force resulting from the displacement of water is also of concern, especially for dry floodproofed buildings and aboveground and underground tanks. Buoyancy force is resisted by the dead load of the building or the weight of the tank. When determining buoyancy force, the weight of occupants or other live loads (such as the contents of a tank) should not be considered. If the building or tank does not weigh enough when empty, then additional stabilizing measures need to be taken to avoid flotation. This becomes a significant consideration for designs intended to dry floodproof a building (described in Section 5.3.5). Buoyancy force is slightly larger in saltwater, because saltwater weighs slightly more than fresh water.

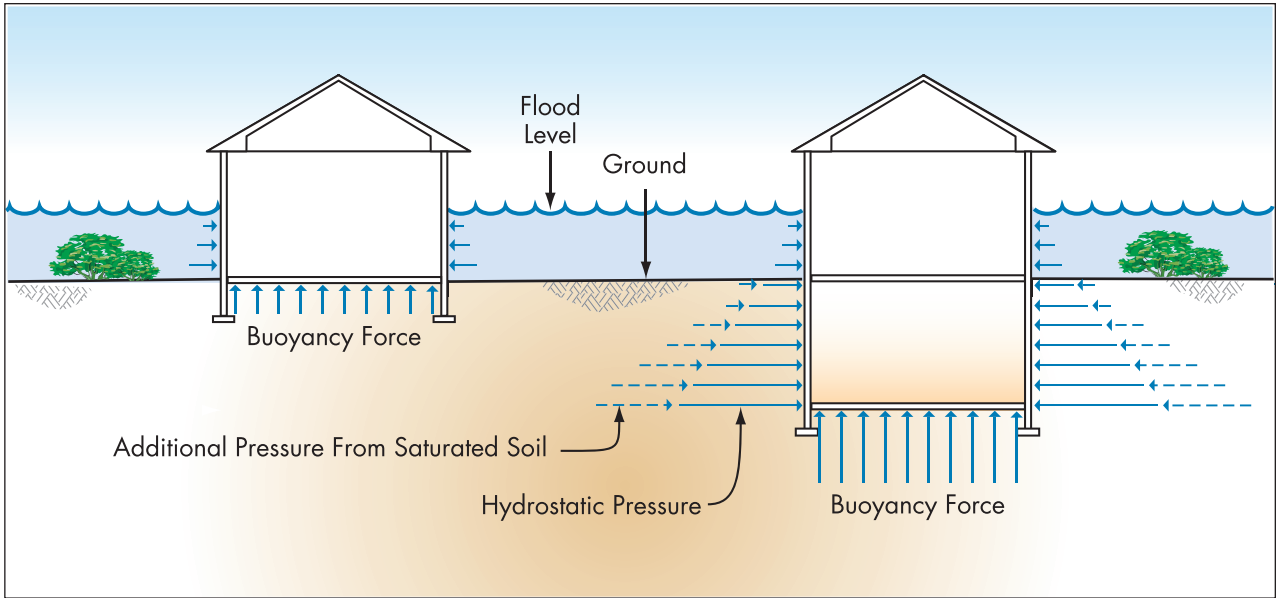

Figure 5-4: Hydrostatic loads on buildings

### 5.1.3.2 Hydrodynamic Loads

Water flowing around a building or a foundation structural element below the flood level imposes hydrodynamic loads. The loads, which are a function of flow velocity and structure geometry, include frontal impact on the upstream face, drag along the sides, and suction on the downstream side (see Figure 5-5). Breaking waves also impart hydrodynamic loads. Ways to determine or estimate flood velocities are described in Section 5.1.4.3 (riverine) and Section 5.1.4.4 (coastal).

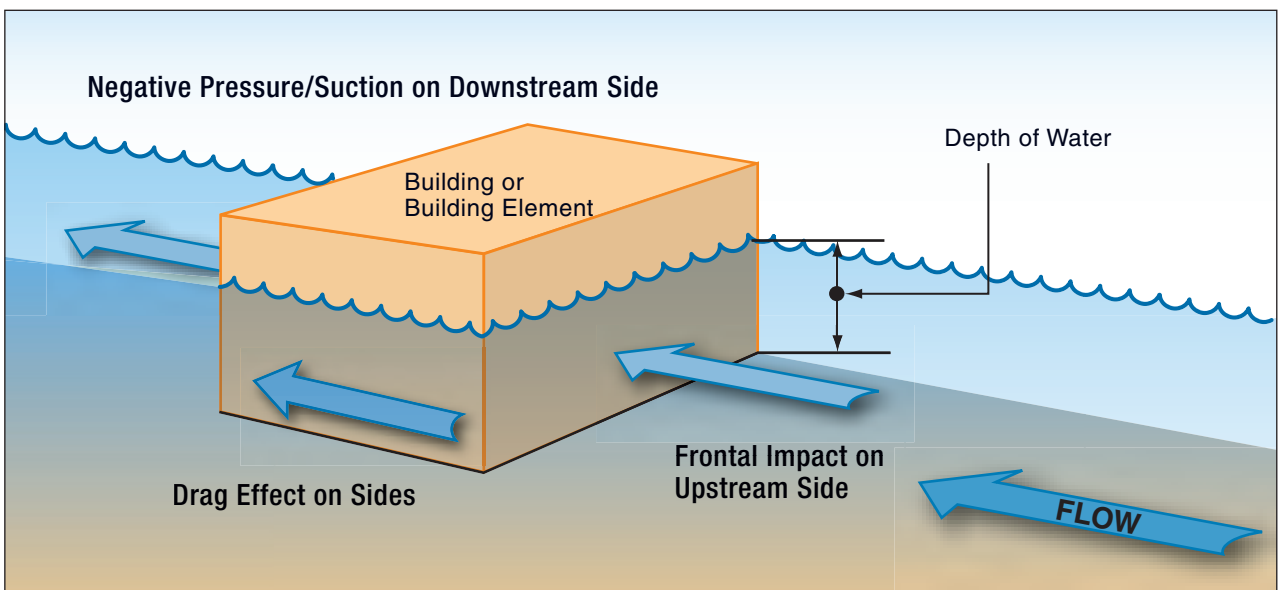

Figure 5-5: Hydrodynamic loads on a building or building element

The most common computation methods for hydrodynamic loads are outlined in the design standard ASCE 7, produced by the American Society of Civil Engineers' Structural Engineers Institute (ASCE/SEI). These methods assume that the flood velocity is constant (i.e., steady state flow) and the hydrodynamic loads are then determined according to the principles of fluid mechanics or hydraulic models. For practical applications, hydrodynamic loads become important when flow reaches moderate velocities of 5 feet per second. Drag coefficients for common building elements, such as columns and piers, can be found in a number of sources and ASCE 7 recommends values for a variety of conditions.

Wave loads are another important component of hydrodynamic loads. As described in ASCE 7, “design and construction of buildings and other structures subject to wave loads shall account for the following loads: waves breaking on any portion of the building or structure; uplift forces caused by shoaling waves beneath a building or structure, or portion thereof; wave runup striking any portion of the building or structure; wave-induced drag and inertia forces; and wave-induced scour at the base of a building or structure, or its foundation.”

Wave forces striking buildings and building elements can range from 10 to more than 100 times wind or other forces. Forces of this magnitude can be substantial, even when acting over the relatively small surface area of the supporting structure of elevated buildings. Post-storm damage inspections show that breaking wave loads overwhelm virtually all wood-frame and unreinforced masonry walls below the wave crest elevation. Only engineered or massive structural elements are capable of consistently withstanding breaking wave loads.

The magnitude of wave forces provides the rationale for the floodplain management requirement that the bottom of the lowest horizontal structural member be at or above the design flood elevation (DFE) in environments where high-velocity wave action from storms or seismic sources is possible (called “V zones,” also referred to as Coastal High Hazard Areas). In V zones, breaking wave heights or wave runup depths are predicted to be 3 feet or higher. Because breaking waves as small as 1.5 feet in height can impose considerable loads, there is a growing awareness of the value of accounting for waves in areas immediately landward of V zones, which are referred to as “Coastal A Zones” (see Section 5.1.5.3).

Of the variety of wave forces described in ASCE 7—breaking waves, uplift, wave runup, wave-induced drag and inertia, and scour—breaking waves constitute the greatest hazard. Designers should therefore use breaking wave forces as the basis of the design load. Computation of breaking wave loads depends on the determination of wave height.

For more information on estimating wave heights, see Section 5.1.4.1. Designers should refer to ASCE 7 for detailed discussion and computation procedures for determining breaking wave loads.

Breaking wave loads on vertical walls or supporting structural members reach a maximum when the direction of wave approach is perpendicular to the wall. It is common to assume that the direction of approach will be perpendicular to the shoreline, in which case the orientation of the wall to the shoreline will influence the direction of approach used in load calculations. ASCE 7 provides a method to reduce breaking wave loads on vertical walls when waves are expected to approach a building from a direction other than straight on.

Breaking wave forces are much higher than typical wind pressures, even wind pressures that occur during a hurricane or typhoon. However, the duration of individual loads is brief, with peak pressures probably occurring within 0.1 to 0.3 seconds after the wave breaks. Structures are to be designed for repetitive impact loads that occur over the duration of a storm. Some storms may last just a few hours, as hurricanes move through the area, or several days, as during some winter coastal storms (nor'easters) that affect the Mid-Atlantic and northeastern States.

### 5.1.3.3 Debris Impact Loads

Debris impact loads on a building or building element are caused by objects carried by moving water. Objects commonly carried by floodwaters include trees, trash containers, outdoor furniture, storage sheds, dislodged tanks, and remnants of manmade structures such as docks and buildings. Extreme impact loads result from less common sources, such as shipping containers, boats, and barges. The magnitude of these loads is very difficult to predict, yet some reasonable allowance for the possibility of debris impacts should be made during the design process.

Impact loads are influenced by the location of the building in the potential debris stream. The potential for debris impacts is significant if a building is located immediately adjacent to, or downstream from, other buildings, among closely spaced buildings, or downstream of large floatable objects. While these conditions may be observable in coastal areas, estimating the potential for debris is more difficult in riverine flood hazard areas. Any riverine waterway, whether a large river or smaller urban stream, can carry large quantities of debris, especially uprooted trees and trash.

The basic equation for estimating the magnitude of impact loads depends on the values of several variables, which must be determined by the designer. These variables include several coefficients, building or

building element stiffness, debris weight, debris velocity, and duration of impact. The latter three variables, described in more detail in ASCE 7, are briefly described below.

**Debris weight:** Debris weight is one of the more difficult variables to estimate. Unless otherwise indicated by field conditions, ASCE 7 recommends using an average object weight of 1,000 pounds. This weight corresponds to a 30-foot long log that is 1 foot in diameter, which is relatively small compared to large trees that may be uprooted during a flood. In coastal areas, expected debris weights depend on the nature of the debris. In the Pacific Northwest, large trees and logs are common, with weights in excess of 4,000 pounds. In areas where piers and pilings are likely to become debris, 1,000 pounds is reasonable. In areas where most debris is likely to result from building damage (failed decks, steps, failed walls, propane tanks), the average debris weight may be less than 500 pounds.

**Debris velocity:** The velocity of the debris when it strikes a building depends on the nature of the debris and the velocity of floodwaters. For the impact load computation, the velocity of the waterborne object is assumed to be the same as the flood velocity. Although this assumption is reasonable for smaller objects, it is considered conservative for large objects.

**Debris impact duration:** Duration of impact is the elapsed time during which the impact load acts on the building or building element. The duration of impact is influenced primarily by the natural frequency<sup>1</sup> of the building or element, which is a function of the building's stiffness. Stiffness is determined by the properties of the material, the number of supporting members (columns or piles), the height of the building above the ground, and the height at which the element is struck. Despite all the variables that may influence duration of impact, an early approach suggested assuming a 1-second duration. A review of results from several laboratory tests that measured impacts yielded much briefer periods, and ASCE 7 currently recommends the duration of 0.03 second.

#### 5.1.3.4 Erosion and Local Scour

Strictly speaking, erosion and scour are not loads; however, they must be considered during site evaluation and load calculations because they increase the local flood depth, which in turn influences load calculations.

Erosion may occur in riverine and coastal flood hazard areas. In coastal areas, storms can erode or completely remove sand dunes, which act as

---

<sup>1</sup> Natural frequency is the frequency at which an object will vibrate freely when set in motion.



barriers to flooding and damaging waves. Erosion may also lower the ground surface or cause a short-term or long-term recession of the shoreline. In areas subject to gradual erosion of the ground surface, additional foundation embedment depth can mitigate the effects. However, where waterways are prone to changing channels and where shoreline erosion is significant, engineered solutions are unlikely to be effective. Avoidance of sites in areas subject to active erosion is usually the safest and most cost-effective course of action.

Local scour results from turbulence at the ground level around foundation elements. Scour occurs in both riverine and coastal flood hazard areas, especially in areas with erodible soils. Determining potential scour is critical in the design of foundations, to ensure that the bearing capacity or anchoring resistance of the soil around posts, piles, piers, columns, footings, or walls is not compromised. Scour determinations require knowledge of the flood depth, velocity, waves, soil characteristics, and foundation type.

At some locations, soil at or below the ground surface can be resistant to local scour, and calculated scour depths based on unconsolidated surface soils below will be excessive. If the designer believes the underlying soil at a site may be scour-resistant, a geotechnical engineer or geologist should be consulted.

### 5.1.4 Design Parameters

Flood hazards and characteristics of flooding must be identified to evaluate the impact of site development and to determine the design parameters necessary to calculate flood loads, to design floodproofing measures, and to identify and prioritize retrofit measures for existing schools. Table 5-3 in Section 5.6 outlines a series of questions to facilitate this objective.

#### 5.1.4.1 Flood Depth

Flood depth is the most important factor required to compute flood loads because almost every other flood load calculation depends directly or indirectly on this factor. The first step in determining flood depth at a specific site is to identify the flood that is specified by the building code or floodplain management regulations enforced by the governing authority. The most common flood used for design is the “base flood” (see Section 5.1.4.2). ASCE 24 provides clear direction on identifying the regulatory flood. Local regulations and requirements should be compared to ASCE 24 and the most restrictive condition should be followed. The second step is to determine the expected elevation of the ground at the site. This expected ground elevation must account for any

erosion, scour, subsidence, or other ground eroding condition that occurs over time. Flood depth is computed by subtracting the ground elevation from the flood elevation. Since these data are usually obtained from different sources, determining whether they are based on the same datum is important. If not, standard datum corrections must be applied.

In coastal areas, the flood elevations shown on FEMA flood maps account for stillwater flooding plus local wave effects, including wave heights, wave runup, or wave overtopping over vertical walls. As shown in Figure 5-6, subtracting the ground elevation from the FEMA flood elevation results in the flood depth which is comprised of the stillwater component and the predicted wave contribution.

**Figure 5-6:**  
Definition sketch –  
coastal wave height and  
stillwater depth

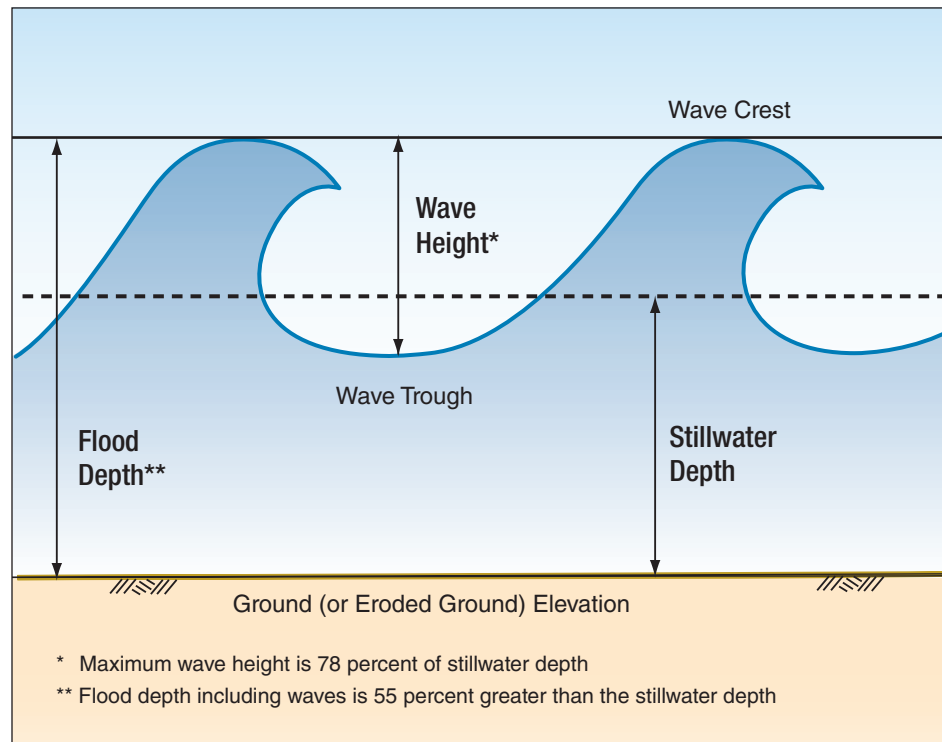

For design purposes, it is important to know that wave forces on buildings cause the most damage. FEMA has identified V zones (velocity zones) on coastal flood maps, where wave heights or wave runup depths are predicted to be 3 feet or greater (see Section 5.1.5.2). However, post-disaster assessments and laboratory studies have shown that waves heights as small as 1.5 feet can also cause significant damage. While FEMA flood maps do not specifically designate flood hazard areas subject to 1.5- to 3-foot waves, referred to as “Coastal A Zones” (see Section 5.1.5.3), these smaller waves and their potential damaging effects on buildings should still be considered.

Figure 5-6 also illustrates the two main principles used to estimate wave heights at a particular site. Equations for wave height are based on the concept that waves are depth-limited, that is, waves propagating into shallow water will break when the wave height reaches a certain proportion of the underlying stillwater depth. For modeling wave heights during the base flood, FEMA utilizes the proportion first determined by the National Academy of Sciences (1977): the total wave height will reach a maximum of 78 percent of stillwater depth before breaking. At any given site, this proportion may be reduced because of obstructions between open water and the site, such as dense stands of vegetation or unelevated buildings. In V zones, 3-foot waves can be supported in only 4 feet of stillwater and 1.5-foot waves can be supported in only 2 feet of stillwater depth. The second principle is that the wave height extends from the trough, which is below the stillwater elevation, to the crest, which is above the stillwater elevation, and is equal to 55 percent of this stillwater depth.

Using these two principles, some general rules of thumb are available to estimate wave heights. If the only information available is the base flood depth (i.e., the flood depth calculated using the FEMA flood map elevation minus the ground elevation), assume that flood depths between 3 and 6 feet can have an added wave-height component between 1.5 and 3 feet, while flood depths of 6 feet or more will likely have wave heights in excess of 3 feet. If only the stillwater flood depth is known (from an alternative surge map or other data source), the maximum flood depth (including wave height) will be approximately 1.5 times the stillwater depth.

In any area with erodible soils, whether coastal or inland site, designers must consider the effects of erosion where floodwaters lower the ground surface or cause local scour around foundation elements. The flood depth determined using flood elevation and ground elevation should be increased to account for changes in conditions during a flood event. Not only does lowering the ground surface effectively result in deeper water against the foundation, it may also remove supporting soil from the foundation, which must be accounted for in the foundation design.

Waves and storm-induced erosion are most common in coastal areas. However, wide rivers and lakes may experience wind-driven waves and erodible soils are found throughout the United States. For more information about waves and erosion, refer to FEMA 55, *Coastal Construction Manual* (2000).

After Hurricane Katrina in 2005, FEMA expedited development of Flood Recovery Maps and Advisory Base Flood Elevations for the Mississippi coast; the new maps were delivered less than 3 months after the storm.

In 2004, after widespread wildfires in California changed rainfall-runoff characteristics, FEMA developed Flood Recovery Maps to show increased riverine flood hazards.

### 5.1.4.2 Design Flood Elevation

The DFE establishes the minimum level of flood protection that must be provided. For school buildings, the DFE will always be higher than the BFE. Communities may use a design flood that is higher than the base flood for a number of reasons. For example, a design flood may be used to account for future upland development, to recognize a historic flood, or to incorporate a factor of safety, known as freeboard.

School districts, facility planners, and designers should check with the appropriate regulatory authority to determine the minimum flood elevation to be used in site planning and building design. If a regulatory authority does not enforce a building code that refers to the standard *Flood Resistant Design and Construction* (ASCE 24), planners and designers should examine the provisions of that standard and discuss with decisionmakers the merits of conforming with this engineering standard of care.

**“Freeboard”** is a factor of safety usually expressed in feet above a flood level. Freeboard compensates for the many unknown factors that could contribute to flood heights, such as wave action, constricting bridge openings, and the hydrological effect of urbanization of the watershed. ASCE 24 requires that new schools with a population of 250 or more be constructed, at a minimum, to an elevation of the BFE + 2 feet in V Zones and Coastal A Zones (depending upon the orientation of the lowest floor member).

Some State or local regulations cite the 0.2-percent-annual-chance flood (500-year flood) as the design requirement for essential and critical facilities such as schools, or the regulations may call for added freeboard above the minimum flood elevation. Even if there is no specific requirement to use the 0.2-percent-annual-chance flood for siting and design purposes, FEMA strongly recommends that

decisionmakers take into consideration the flood conditions associated with this lower probability event.

If significant flood events have occurred since the effective date of the FIRM, these events may change the statistical analyses, which might prompt FEMA to update of the flood maps and produce revised elevations for the 1-percent-annual-chance flood. School districts, facility planners, and designers should contact appropriate community officials to determine whether any significant flood events have occurred or if other changes that might affect flood hazards have taken place since the effective date of the FIRM. The best available information should be used at all times.

### 5.1.4.3 Flood Velocity—Riverine

Few sources of information are readily available for estimating flood velocities at specific locations along riverine bodies of water. If a riverine source has been studied using detailed hydraulic methods, some information may be available in summary form in published flood studies. Studies prepared for the NFIP contain tables of data for waterways for which floodways were delineated (see Section 5.1.5.2). For specified cross-sections along the waterway, these Floodway Data Tables include mean velocities expressed in feet per second. These values are the average of all velocities across the floodway. Generally, velocities in the flood fringe (landward of the floodway) will be lower than in the floodway.

For waterways without detailed studies, methods that are commonly used in civil engineering for estimating open channel flow velocities can be applied.

### 5.1.4.4 Flood Velocity—Coastal

Estimating flood velocities in coastal flood hazard areas involves considerable uncertainty and there is little reliable historical information or measurements from actual coastal flood events. In this context, velocity does not refer to the motion associated with breaking waves, but the speed of the mass movement of floodwater over an area.

The direction and velocity of floodwaters can vary significantly throughout a coastal flood event. Floodwaters can approach a site from one direction as a storm approaches, then shift to another direction (or through several directions) as the storm moves through the area. Floodwaters can inundate some low-lying coastal sites from both the front (e.g., ocean) and the back (e.g., bay, sound, or river). In a similar manner, at any given site, flow velocities can vary from close to zero to very high. For these reasons, when determining flood loads for building design, velocities should be estimated conservatively, and floodwaters should be assumed to approach from the most critical direction.

Despite the uncertainties, there are methods to approximate coastal flood velocities. One common method is based on the stillwater depth. Designers should consider the topography, the distance from the source of flooding, and the proximity to other buildings and obstructions before selecting the flood velocity for design. Those factors can direct and confine floodwaters, with a resulting acceleration of velocities. This increase in velocities is

Upper bound velocities caused by Hurricane Katrina along the Mississippi coast, where storm surge depths neared 25 feet deep (with waves, total flood depths approached 35 feet), have been estimated at nearly 30 feet per second (20 miles per hour).

described as the “expected upper bound.” The “expected lower bound” velocities are experienced in areas where those factors are not expected to influence the direction and velocity of floodwaters.

Figure 5-7 shows the general relationship between velocity and stillwater depth. For design purposes, actual flood velocities are assumed to lie between the upper and lower bounds. Conservative designs will use the upper bound velocities.

**Figure 5-7:**  
Velocity as a function  
of stillwater flood depth

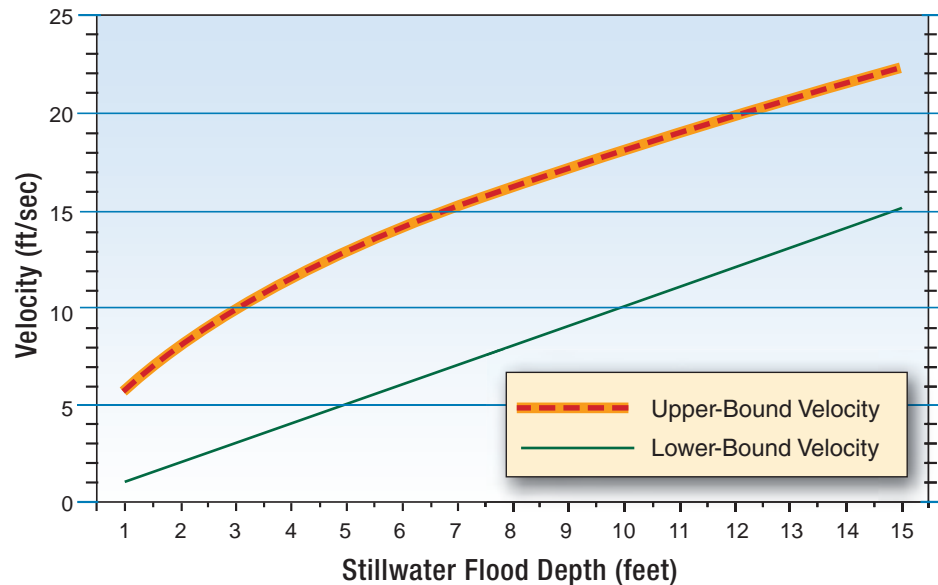

### 5.1.5 Flood Hazard Maps and Zones

Flood hazard maps identify areas of the landscape that are subject to flooding, usually flooding by the 1-percent-annual-chance flood. Maps prepared by the NFIP are the minimum basis of State and local floodplain regulatory programs. Some States and communities have prepared maps of a floodplain based on the assumption that the upper watershed area is fully developed according to existing zoning. Some communities base their regulations on a flood of record or a historically significant flood that exceeds the base flood shown on the NFIP maps.

The flood hazard maps used by the appropriate regulatory authority should be consulted during planning and site selection, site design, and architectural and engineering design (whether for the design of new buildings or rehabilitation of existing buildings). Regardless of the flood hazard data required for regulatory purposes, additional research should be conducted on past major floods and other factors that could lead to more severe flooding.



### 5.1.5.1 NFIP Flood Maps

The NFIP produces FIRMs for more than 20,000 communities nationwide. Flood Insurance Studies (FISs) and FIRMs are prepared for each local jurisdiction that has been determined to have some degree of flood risk. The current effective maps are typically available for viewing in community planning or permit offices.<sup>2</sup> Using the most recent flood hazard map is important when determining site-specific flood hazard characteristics. Although many FIRMs are more than 15 years old, often one or more panels or portions of a map panel have been revised and republished. Communities must adopt revised maps to continue participating in the NFIP.

The number of revised and updated FIRMs is increasing rapidly. During the last few years, FEMA, in partnership with many States and communities, has been implementing an initiative to modernize and update all maps that are determined to be out of date. The modernization process may involve an examination of flood experience in the period since the original flood studies were prepared, use of more detailed topographic and base maps, re-computation of flood discharges and flood heights, and re-delineation of flood hazard area boundaries.

Some FIRMs do not show the 0.2-percent-annual-chance flood hazard area (500-year floodplain), and many FIRMs do not provide detailed information about predicted flood elevations along every body of water, especially smaller streams and tributaries. Determining the 500-year flood is especially difficult when records of past flood events are limited. When existing data are insufficient, additional statistical methods and engineering analyses are necessary to determine the floodprone areas and the appropriate characteristics of flooding required for site layout and building design. If a proposed school site or existing school campus is affected by flooding, a site-specific topographic survey is critical to delineate the land that is below the flood elevation used for planning purposes. If detailed flood elevation information is not available, a floodplain study may be required to identify the important flood characteristics and data required for sound design. However, having flood hazard areas delineated on a map conveys a degree of precision that may be misleading. Flood maps have a number of limitations that should be taken into consideration, especially during site selection and building design. Some of the well-known limitations include:

- Flood hazard areas are approximations based on probabilities; the flood elevations shown and the areas delineated should not be taken as absolutes, in part because they are based on numerical approximations of the real world.
- For the most part, floodplains along smaller streams and drainage areas (less than 1 square mile) are not shown.

<sup>2</sup> Flood maps may also be viewed at FEMA's Map Service Center at <http://msc.fema.gov>. For a fee, copies may be ordered online or by calling (800) 358-9616. The FIS and engineering analyses used to determine the flood hazard area may be ordered through the FEMA Web site.

In communities along the Gulf and Atlantic coasts, school districts, planners, and designers should check with emergency management offices or the U.S. Army Corps of Engineers for maps that estimate storm surge flooding from several hurricane scenarios. Local planning or engineering offices may have post-disaster advisory flood maps and documentation of past storm surge events. The FIRMs and regulatory BFEs do not reflect low probability/high magnitude flooding that may result from a hurricane making landfall at a specific location.

Be aware that most storm surge maps report stillwater flood elevations only; local wave heights or wave runup are seldom included. If necessary, local wave effects should be estimated and added to the stillwater elevation when determining flood depths for design purposes (see Section 5.1.4.1).

- Especially for older maps, the topography used to delineate the flood boundary may have had contour intervals of 5, 10, or even 20 feet, which significantly affects the precision with which the boundary is determined. The actual elevation of the ground relative to the flood elevation is more critical to consider than whether an area is shown as being in or out of the mapped flood hazard area.
  - Maps are based on the data available at the time they were prepared, and, therefore, do not account for subsequent upland development that increases rainfall-runoff, which may increase flooding.
  - The scale of the maps may impede precise determinations (many older maps are 1 inch = 2,000 feet).
  - The land surface of the floodplain may have been altered by modifications after the maps were prepared, including fills, excavations, or levees.
  - Local conditions are not reflected, especially conditions that change regularly, such as stream bank erosion and shoreline erosion.
- Areas exposed to very low probability flooding are not shown, such as flooding from extreme hurricane storm surges, extreme riverine flooding, dam failures, or overtopping or failure of levees.

#### 5.1.5.2 NFIP Flood Zones

The flood hazard maps prepared by the NFIP show different flood zones to delineate different floodplain characteristics (see Figures 5-8, 5-9, and 5-10). The flood zones shown on the NFIP maps, and some other designations, are described below.

**A Zones:** Also called “unnumbered A zones” or “approximate A zones,” this designation is used for flood hazard areas where engineering studies have not been performed to develop detailed flood elevations. BFEs are not provided. Additional engineering analyses and site-specific assessments usually are required to determine the BFE.

**AE Zones or A1–A30 Zones:** Also called “numbered A zones,” these designations are used for flood hazard areas where engineering analyses have produced detailed BFEs and boundaries for the base flood

(1-percent-annual-chance flood). For riverine waterways with numbered A zones, FISs include longitudinal profiles showing water surface elevations for different frequency flood events.

**Base flood elevation (BFE)** is the elevation above a datum to which floodwaters are predicted to rise during the 1-percent-annual-chance flood (also called the “base flood” or the 100-year flood).

**Floodways:** The floodway includes the waterway channel and adjacent land areas that must be reserved in order to convey the discharge of the base flood without cumulatively increasing the water surface elevation above a designated height. Floodways are designated for most waterways that have AE zones or numbered A zones. FISs include data on floodway widths and mean floodway velocities.

**AO and AH Zones:** These zones include areas of shallow flooding and are generally shown where the flood depth averages from 1 to 3 feet, where a clearly defined channel does not exist, where the path of flooding is unpredictable, and where velocity flow may be evident. These zones are characterized by ponding or sheetflow. BFEs may be provided for AH zones; flood depths may be specified in AO zones.

**Shaded X (or B) Zones:** These designations are used to show areas subject to inundation by the 500-year flood (0.2-percent-annual-chance flood), or areas protected by flood control levees. These zones are not shown on many NFIP maps, though the absence does not imply that flooding of this frequency will not occur.

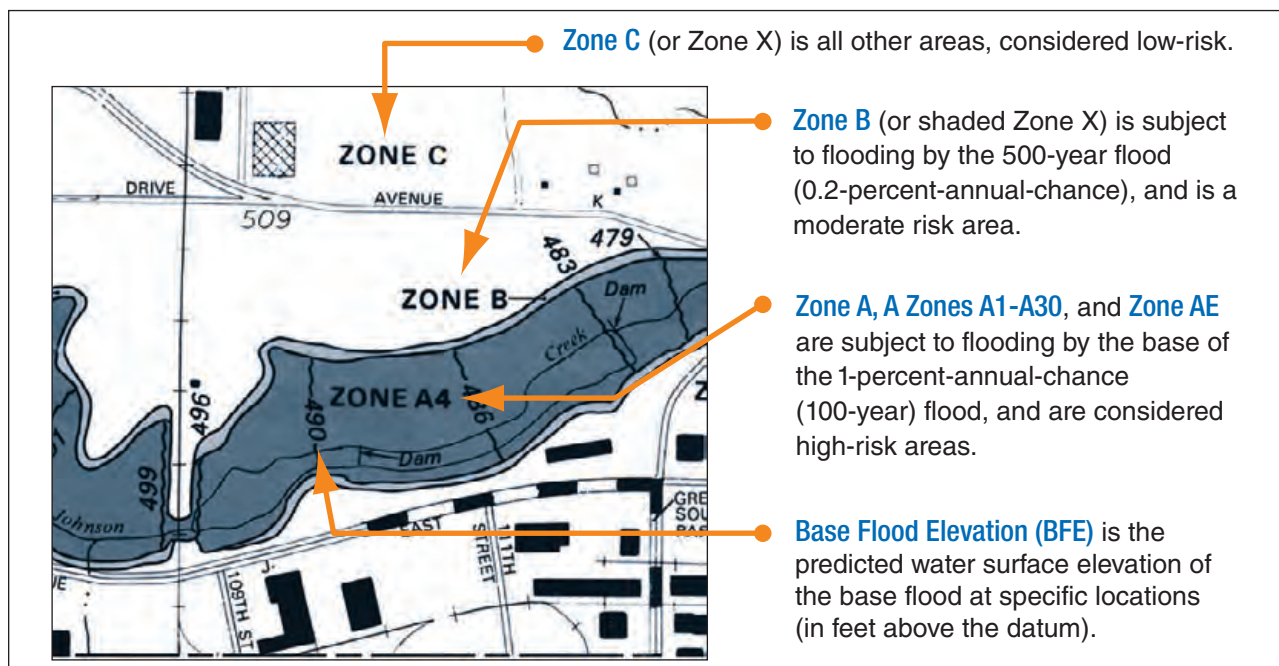

Figure 5-8: Riverine flood hazard zones

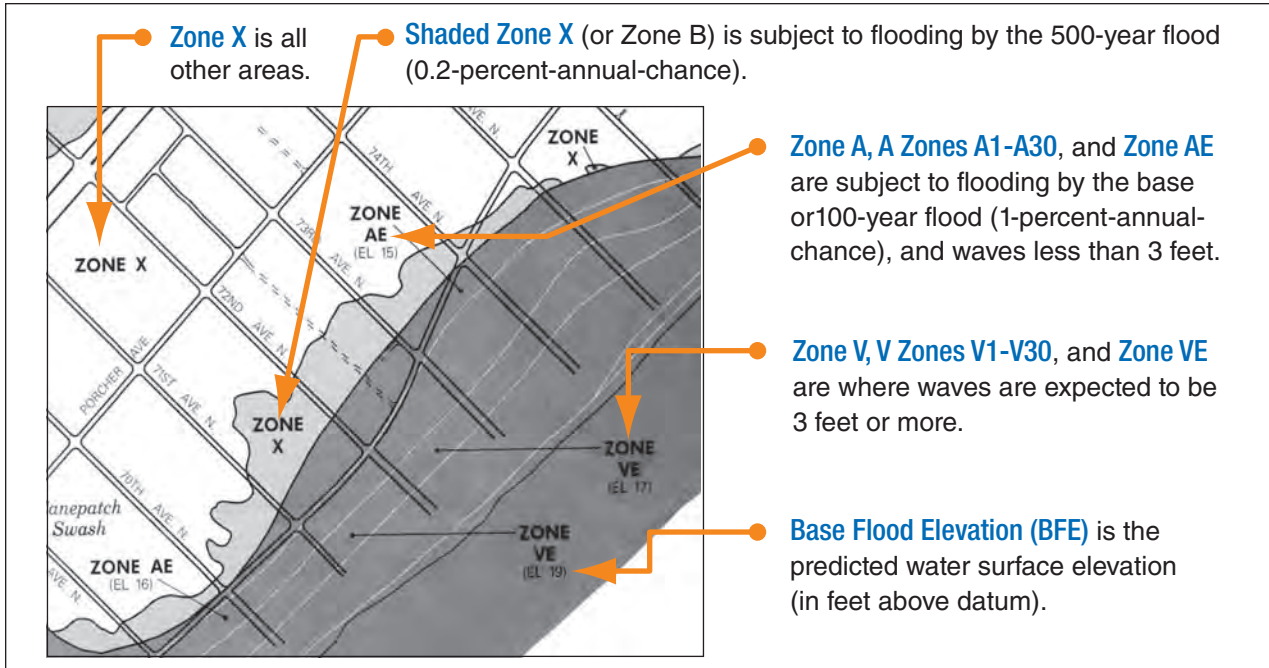

Figure 5-9: Coastal flood hazard zones

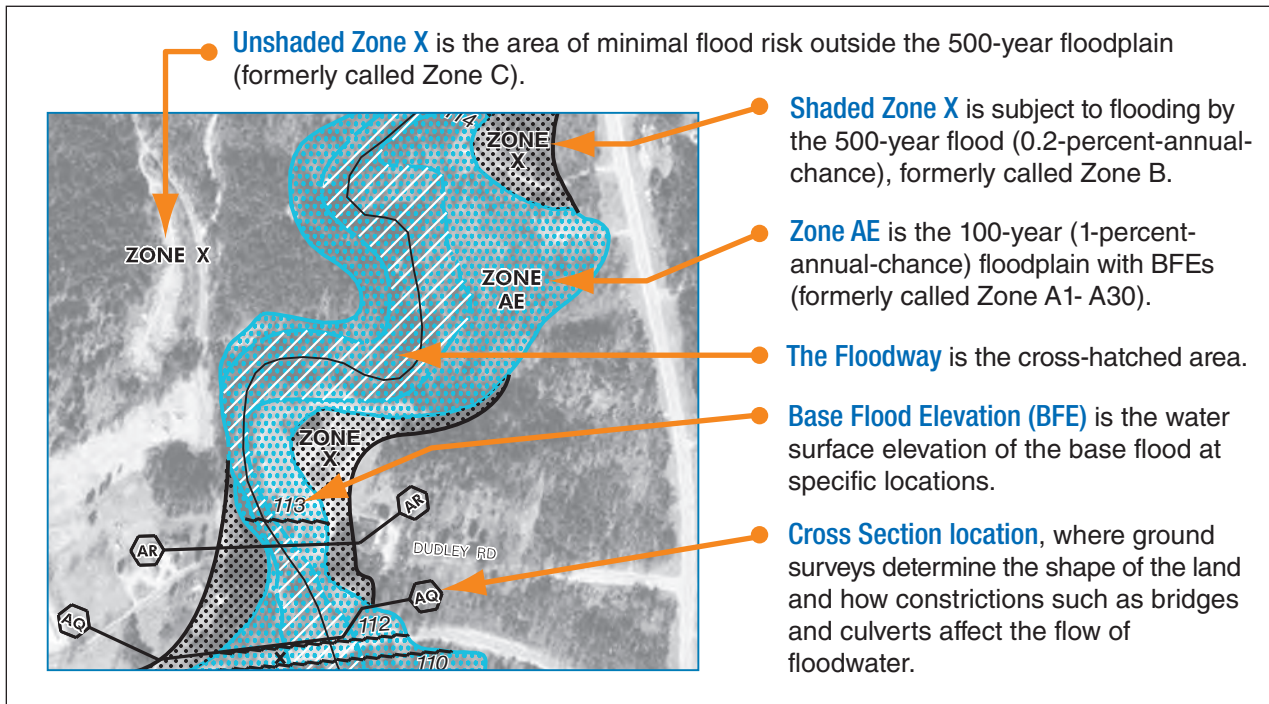

Figure 5-10: Sample digital FIRM format used for modernized maps

**Unshaded X (or C) Zones:** These zones are all land areas that are outside of the mapped flood hazard area designated for the purposes of regulating development. These zones may still be subject to small stream flooding and flooding from local drainage problems.



**V Zones (V, VE, and V1–V30):** Also known as coastal high hazard areas or special flood hazard areas (SFHAs) subject to high-velocity wave action, V zones are relatively narrow areas along open coastlines and some large lake shores that are subject to high-velocity wave action from storms or seismic sources. V zones extend from offshore to the inland limit of primary frontal dunes, or to an inland limit where the predicted breaking wave height or wave runup depth drops below 3 feet.

**5.1.5.3 Coastal A Zones**

Figure 5-9 shows that coastal floodplains are typically subdivided into A zones and V zones. V zones are areas where wave heights or runup depths exceed 3 feet or where primary frontal dunes occur. Most NFIP maps do not differentiate the portions of the A zone that will experience wave heights between 1.5 and 3 feet, which are capable of causing structural damage to buildings. These areas of special concern, called Coastal A Zones, can be identified through assessment of coastal flood hazard data. Beginning in 2008, when FEMA revises and updates FIRMs for coastal communities, the inland extent of the 1.5-foot wave—called the Limit of Moderate Wave Action (LiMWA)—will be delineated (Figure 5-11).

Coastal A Zones are present where two conditions exist: where the expected stillwater flood depth is sufficient to support breaking waves 1.5 to 3 feet high, and where such waves can actually occur. The first condition occurs where stillwater depths (vertical distance between the stillwater elevation and the ground) are more than 2 feet deep. The second condition occurs where there are few obstructions between the shoreline and the site. In these areas, the principal sources of flooding are tides, storm surges, seiches, or tsunamis, not riverine flooding.

The stillwater depth requirement is necessary, but is not sufficient by itself to warrant designation as a Coastal A Zone. This is because obstructions in the area may block wind (limiting the initial growth of waves) or cause friction that attenuates wave

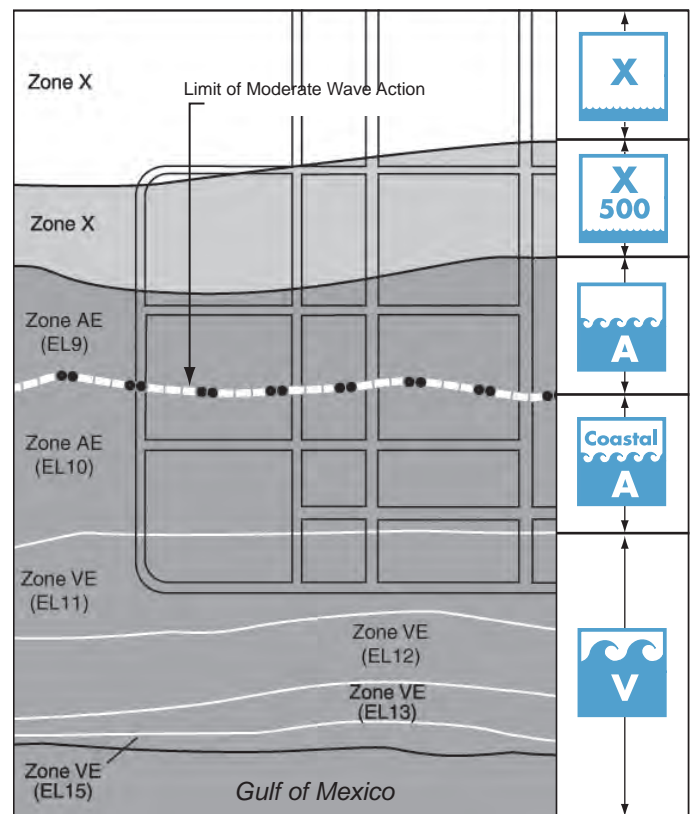

**Figure 5-11:** Illustration of the Limit of Moderate Wave Action, which delineates the inland limit of areas referred to as Coastal A Zones

The current editions of the model building codes refer to two design standards, ASCE 7 and ASCE 24. Both standards include requirements for Coastal A Zones.

energy. Obstructions can include buildings, locally high ground, and dense, continuous stands of vegetation (trees, shrubs, etc.). Designers should determine whether Coastal A Zone conditions are likely to occur at a school site because of the anticipated wave action and loads. This determination is based on an examination of the site and its surroundings,

the actual surveyed ground elevations, and the estimated wave heights (calculated using predicted stillwater elevations found in the FIS or derived from elevations shown on the FEMA flood map; see Section 5.1.4.1).

When a decision is made to build a school in a Coastal A Zone, the characteristics of the site and the nature of the flood hazards must be examined prior to making important design decisions. Field observations and laboratory research have determined that flooding with breaking waves between 1.5 and 3 feet high produces more damage than flooding of similar depths without waves. Therefore, ASCE 24, *Flood Resistant Design and Construction*, specifically requires application of the NFIP's V zone design requirements in Coastal A Zones. Designers are advised to pay special attention to two additional considerations:

- Debris loads may be significant in Coastal A Zones landward of V zones where damaged buildings, piers, and boardwalks can produce battering debris. Damage caused by debris can be minimized if foundations are designed to account for debris impact loads.
- Especially in high-wind regions, designers must pay special attention to the entire roof-to-foundation load path when designing and specifying connections. To meet V zone requirements, designs for buildings in Coastal A Zones should account for simultaneous wind and flood forces. Corrosion-resistant connections are especially important for the long-term integrity of the structure.

### 5.1.6 Floodplain Management Requirements and Building Codes

The NFIP sets the minimum requirements included in model building codes and standards for design and construction methods to resist flood damage. The original authorizing legislation for the NFIP is the National Flood Insurance Act of 1968 (42 U.S. Code [U.S.C.] 4001 et seq.). In that Act, Congress expressly found that “a program of flood insurance can promote the public interest by encouraging sound land use by minimizing exposure of property to flood losses...”



The most convincing evidence of the effectiveness of the NFIP minimum requirements is found in flood insurance claim payment statistics. Buildings that pre-date the NFIP requirements are, by and large, not constructed to resist flood damage. Buildings that post-date the NFIP (i.e., those that were constructed after a community joined the program and began applying the minimum requirements) are designed to resist flood damage. The NFIP reports that aggregate loss data indicate that buildings that meet the minimum requirements experience 70 percent less damage than buildings that pre-date the NFIP. There is ample evidence that buildings designed to exceed the minimum requirements are even less likely to sustain damage.

Construction of public schools may be regulated by a State board, school district, or State agency and, thus, may not be subject to local permit requirements, including local floodplain management regulations. In these cases, the NFIP minimum requirements must still be satisfied, whether through regulation, Executive order, or a State building code.

#### 5.1.6.1 Overview of the NFIP

The NFIP is based on the premise that the Federal government will make flood insurance available in communities that agree to recognize and incorporate flood hazard considerations in land use and development decisions. In some States and communities, this is achieved by guiding development to areas with a lower risk. When decisions result in development within flood hazard areas, application of the criteria set forth in Title 44 Code of Federal Regulations (CFR) Section 60.3 is intended to minimize exposure and flood-related damage. State and local governments are responsible for applying the provisions of the NFIP through the regulatory permitting processes. At the Federal level, the NFIP is managed by FEMA and has three main elements:

- Hazard identification and mapping, for which engineering studies are conducted and flood maps are prepared in partnership with States and communities. These maps delineate areas that are predicted to be subject to flooding under certain conditions.
- Floodplain management criteria for development establish the minimum requirements to be applied to development within mapped flood hazard areas. The intent is to recognize and incorporate flood hazard considerations throughout the land development process.
- Flood insurance, which provides some financial protection for property owners to cover flood-related damage to buildings and contents.

Federal flood insurance is intended to shift some of the costs of flood disasters away from the taxpayer by providing property owners, including school

If completely destroyed by an event that the President declares a major disaster, schools in V zones are not eligible for post-disaster public assistance funds to rebuild on the same site (44 CFR §9.11(d)(1)). This is another reason to select higher (more conservative) design criteria when designing and constructing schools in areas with a high flood risk.

districts, an alternative to disaster assistance and disaster loans. Disaster assistance provides limited funding for repair and cleanup, and is available only after the President signs a major disaster declaration for the area. NFIP flood insurance claims are paid any time damage from a qualifying flood event<sup>3</sup> occurs, regardless of whether a major disaster is declared. Importantly, school districts should be aware that they may be subject to a mandated reduction in Federal disaster assistance payments if a public school building is damaged by flooding, but is not covered by flood insurance. The same restriction applies to private non-profit schools that are otherwise eligible for Federal disaster assistance.

Another important objective of the NFIP is to break the cycle of flood damage. Many buildings have been flooded, repaired or rebuilt, and flooded again. Before the NFIP, in some parts of the country this cycle was repeated every couple of years, with reconstruction taking place in the same floodprone areas, using the same construction techniques that did not adequately resist flood damage. NFIP provisions guide development to lower-risk areas by requiring compliance with performance measures to minimize exposure of new buildings and buildings that undergo major renovation or expansion (called “substantial improvement” or repair of “substantial damage”). This achieves the long-term objective of building disaster-resistant communities.

**“Substantial damage”** is damage of any origin sustained by a structure whereby the cost of restoring the structure to its before-damage condition would equal or exceed 50 percent of the market value of the structure before the damage occurred.

**“Substantial improvement”** is any repair, reconstruction, rehabilitation, addition, or improvement of a building, the cost of which equals or exceeds 50 percent of the market value of the building before the improvement or repair is started (certain historic structures may be excluded).

#### 5.1.6.2 Summary of the NFIP Minimum Requirements

The performance requirements of the NFIP are set forth in 44 CFR Part 60. The requirements apply to all development, which the NFIP broadly defines to include buildings and structures, site work, roads and bridges, and other activities. Buildings must be designed and constructed to resist flood damage, which is primarily achieved through elevation (or floodproofing). Additional specific requirements apply to existing development, especially existing buildings. Existing buildings that are proposed for substantial improvement, including restoration following substantial damage, are subject to the regulations.

3 For the purpose of adjusting claims for flood damage, the NFIP defines a flood as “a general and temporary condition of partial or complete inundation of two or more acres of normally dry land area or of two or more properties (at least one of which is the policyholder’s property) from: overflow of inland or tidal waters; unusual and rapid accumulation or runoff of surface waters from any source; mudflow; or collapse or subsidence of land along the shore of a lake or similar body of water as a result of erosion or undermining caused by waves or currents of water exceeding anticipated cyclical levels that result in a flood as defined above.”

Although the NFIP regulations primarily focus on how to build structures, one of the long-term objectives of the program is to guide development to less hazardous locations. Preparing flood hazard maps and making the information available to the public is fundamental in satisfying this objective. Armed with flood hazard information, people can make informed decisions about where to build, how to use site design to minimize exposure to flooding, and how to design buildings that will resist flood damage.

The NFIP's broad performance standards for development sites in flood hazard areas include the following requirements:

- Building sites shall be reasonably safe from flooding.
- Adequate site drainage shall be provided to reduce exposure to flooding.
- New and replacement sanitary sewage systems shall be designed to minimize or eliminate infiltration of floodwaters into the systems and discharges from the systems into floodwaters.
- Development in floodways shall be prohibited, unless engineering analyses show that the development will not increase flood levels.

The NFIP's broad performance standards for new buildings proposed for flood hazard areas (and substantial improvement of existing floodprone buildings) include the following requirements:

- Buildings shall be designed and adequately anchored to prevent flotation, collapse, or lateral movement resulting from hydrodynamic and hydrostatic loads, including the effects of buoyancy.
- Building materials used below the DFE shall be resistant to flood damage.
- Buildings shall be constructed by methods and practices that minimize flood damage (primarily by elevating to or above the DFE, or by specially designed and certified floodproofing measures).
- Buildings shall be constructed with electrical, heating, ventilation, plumbing, and air-conditioning equipment and other service facilities that are designed and/or located to prevent water from entering or accumulating within the components.

The IBC and ASCE 24 contain several requirements that exceed or are more specific than the NFIP minimum requirements. The most notable is the requirement that schools and certain other buildings and structures be elevated to the higher of the DFE or the BFE plus 1 or 2 feet.

School planners and designers should determine whether there are any applicable State-specific requirements for floodplain development.

Some States require that local jurisdictions apply standards that exceed the minimum requirements of the NFIP. In particular, some States require that schools be located outside of the floodplain (including the 500-year floodplain). Some states require that schools are designed and constructed to resist conditions associated with the 500-year flood or other higher standards, and some States have direct permitting authority over public school construction.

As participants in the NFIP, States are required to ensure that development activities that are not subject to local regulations, such as the development of State-owned properties, comply with the same performance requirements as those enforced by local jurisdictions. If schools are exempt from local permits, this may be accomplished through a State building permit, a governor's executive order, or other mechanisms that apply to entities not subject to local authorities.

### 5.1.6.3 Executive Order 11988 and Critical Facilities

When Federal funding is provided for the planning, design, and construction of new critical facilities, or for the repair of existing critical facilities that are located within the 500-year floodplain, the funding agency is required to address additional considerations. Executive Order 11988, Floodplain Management, requires Federal agencies to apply a decisionmaking process to avoid, to the extent possible, the long- and short-term adverse impacts associated with the occupancy and modification of floodplains, and to avoid the direct or indirect support of floodplain development whenever there is a practicable alternative. If there is no practicable alternative, the Federal agency must take steps to minimize any adverse impacts to life, property, and the natural and beneficial functions of floodplains.

States often use governors' executive orders to influence State-constructed and State-funded critical facilities, requiring location outside of the 500-year floodplain where feasible, or protection to the 500-year flood level if avoiding the floodplain is not practical. In 2004, a review of State and local floodplain management programs determined that Alabama, Illinois, Michigan, New York, North Carolina, Ohio, and Virginia have requirements for critical facilities (ASFP, 2004). Although not identified in that review, other States may have similar restrictions.

The Executive order establishes the BFE as the minimum flood elevation that must be used by all Federal agencies. Implementation guidance specifically addresses "critical actions," which are described as those actions for which even a slight chance of flooding would be too great. The construction or repair of critical facilities, such as schools, hospitals and clinics, fire stations, emergency operations centers, and facilities for storage of hazardous wastes or storage of critical records, are examples of critical actions.

After determining that a site is in a mapped flood hazard area, and after giving public notice, the

Federal funding agency is required to identify and evaluate practicable alternatives to locating a critical facility in a 500-year floodplain. If the Federal agency has determined that the only practicable alternative is to proceed, then the impacts of the proposed action must be identified. If the identified impacts are harmful to people, property, and the natural and beneficial functions of the floodplain, the Federal agency is required to minimize the adverse effects on the floodplain and the funded activity.

Having identified the impacts of the proposed action and the methods to minimize these impacts, the Federal agency is required to re-evaluate the proposed action. The re-evaluation must consider whether the action is still feasible, whether the action can be modified to relocate the facility or eliminate or reduce identified impacts, or whether a “no action” alternative should be chosen. If the finding results in a determination that there is no practicable alternative to locating a critical facility in the floodplain, or otherwise affecting the floodplain, then a statement of findings and a public explanation must be provided.

FEMA's eight-step decisionmaking process for complying with Executive Order 11988 must be applied before Federal disaster assistance is used to repair, rehabilitate, or reconstruct damaged existing critical facilities in the 500-year floodplain.

#### 5.1.6.4 Model Building Codes and Standards

The IBC and NFPA 5000 were the first model codes to include comprehensive provisions that address flood hazards. Both codes are consistent with the minimum provisions of the NFIP that pertain to the design and construction of buildings and structures. The NFIP requirements that pertain to site development, floodways, coastal setback lines, erosion-prone areas, and other environmental constraints are found in other local ordinances.

The IBC and NFPA 5000 incorporate by reference a number of standards that are developed through a formal or accredited consensus process. The best known is ASCE 7. The model building codes require designers to identify and design for anticipated environmental loads and load combinations including wind, seismic, snow and flood loads, as well as the soil conditions. The designer must identify the pertinent, site-specific characteristics and then use ASCE 7 to determine the specific loads and load combinations. In effect, the process is similar to a local floodplain ordinance that requires determination of the environmental condition (in/out of the mapped flood hazard area, DFE/depth of water), and then specifies certain

ASCE 7 outlines methods to determine design loads and load combinations in flood hazard areas, including hydrostatic loads, hydrodynamic loads, wave loads, and debris impact loads. In order to compute the loads and load combinations the designer must identify site-specific characteristics, including flood depths, velocities, waves, and the likelihood that debris impacts need to be considered.

ASCE 24 addresses design and construction requirements for structures in flood hazard areas, including coastal high-hazard areas (V Zones), “Coastal A Zones,” and other flood hazard areas (A Zones).

conditions that must be met during design and construction. The 1998 edition of ASCE 7 was the first version of the standard to include flood loads explicitly, including hydrostatic loads, hydrodynamic loads (velocity and waves), and debris impact loads.

The IBC and NFPA 5000 also incorporate ASCE 24 by reference. ASCE 24 is a standard that was first published by ASCE in 1998 and revised in 2005. Developed through a consensus process, ASCE 24 addresses specific topics pertinent to designing and constructing buildings in flood hazard areas, including floodways, coastal high-hazard areas, and other high-risk flood hazard areas, such as alluvial fans, flash flood areas, mudslide areas, erosion-prone areas, and high-velocity areas.

Prior to the 2010 edition, ASCE 7 and the model building codes classified structures into four categories based on use or occupancy, each with different requirements, and schools were classified based on capacity. The 2010 edition of ASCE 7 categorizes buildings and structures into “risk categories” and no longer includes lists of specific facilities under each category. Schools are expected to be designated as Risk Category III or Risk Category IV in ASCE 7-10:

- **Risk Category III** – Buildings and structures the failure of which could pose a substantial risk to human life and those not included in Risk Category IV with “potential to cause a substantial economic impact and/or mass disruption of day-to-day civilian life in the event of failure.”
- **Risk Category IV** – Buildings and structures designated as essential facilities, and those for which failure could pose a substantial hazard to the community. Essential facilities are defined as those “intended to remain operational in the event of extreme environmental loading from wind, snow, or earthquakes.”

ASCE 24 incorporates the ASCE 7 building classifications (occupancy categories) and establishes elevation requirements for each risk category. Table 5-1 summarizes these elevation requirements, which exceed the NFIP minimum requirements for schools.



Table 5-1: ASCE/SEI 24 provisions related to the elevation of schools

	Occupancy Category III	Occupancy Category IV
<b>Elevation of Lowest Floor or Bottom of Lowest Horizontal Structural Member</b>		
<b>A Zone:</b> elevation of lowest floor	BFE + 1 foot or DFE, whichever is higher	BFE + 2 feet or DFE, whichever is higher
<b>V Zone and Coastal A Zone:</b> where the lowest horizontal structural member is parallel to direction of wave approach	BFE + 1 foot or DFE, whichever is higher	BFE + 1 foot or DFE, whichever is higher
<b>V Zone and Coastal A Zone:</b> where the lowest horizontal structural member is perpendicular to direction of wave approach	BFE + 2 feet or DFE, whichever is higher	BFE + 2 feet or DFE, whichever is higher
<b>Elevation Below which Flood Damage-Resistant Materials Shall be Used</b>		
<b>A Zone</b>	BFE + 1 foot or DFE, whichever is higher	BFE + 2 feet or DFE, whichever is higher
<b>V Zone and Coastal A Zone:</b> where the lowest horizontal structural member is parallel to direction of wave approach	BFE + 2 feet or DFE, whichever is higher	BFE + 2 feet or DFE, whichever is higher
<b>V Zone and Coastal A Zone:</b> where the lowest horizontal structural member is perpendicular to direction of wave approach	BFE + 3 feet or DFE, whichever is higher	BFE + 3 feet or DFE, whichever is higher
<b>Minimum Elevation of Utilities and Equipment</b>		
<b>A Zone</b>	BFE + 1 foot or DFE, whichever is higher	BFE + 2 feet or DFE, whichever is higher
<b>V Zone and Coastal A Zone:</b> where the lowest horizontal structural member is parallel to direction of wave approach	BFE + 2 feet or DFE, whichever is higher	BFE + 2 feet or DFE, whichever is higher
<b>V Zone and Coastal A Zone:</b> where the lowest horizontal structural member is perpendicular to direction of wave approach	BFE + 3 feet or DFE, whichever is higher	BFE + 3 feet or DFE, whichever is higher
<b>Dry Floodproofing</b>		
<b>A Zone:</b> elevation to which dry floodproofing extends	BFE + 1 foot or DFE, whichever is higher	BFE + 2 feet or DFE, whichever is higher
<b>V Zone and Coastal A Zone:</b> dry floodproofing not allowed	Not allowed	Not allowed

## 5.2 Schools Exposed to Flooding

### 5.2.1 Identifying Flood Hazards at School Sites

School districts, facility planners, and designers of schools and school campuses should investigate site-specific flood hazards and characteristics as part of site selection to understand the risks of locating new buildings and other improvements on a site. Where practical, buildings and athletic fields should be located outside of known flood hazard areas. The best available information should be examined, including flood hazard maps, records of historical flooding, storm surge maps, and advice from local experts and others who can evaluate flood risks. Table 5-3 in Section 5.6 outlines questions that should be answered prior to initiating site layout and design work.

This same investigation should be undertaken when examining existing schools and when planning improvements or rehabilitation work.

### 5.2.2 Vulnerability: What Flooding Can Do to Existing Schools

Existing schools that are located in flood hazard areas are exposed to flood damage. The nature and severity of damage are functions of site-specific flood characteristics. As described below, damage may include: site damage; structural and nonstructural building damage; destruction or impairment of service equipment; loss of contents; and health and safety threats due to contaminated floodwater.

Regardless of the nature and severity of damage, flooded schools are typically not functional while cleanup and repairs are undertaken. The length of closure, and thus the impact on the ability of the school district to provide instruction, depends on the severity of the damage and lingering health hazards. It may also depend on whether the building was fully insured or whether disaster assistance is made available quickly to allow speedy repairs and reconstruction. Sometimes, repairs are put on hold pending a determination of whether a school should be rebuilt on the same site. When damage is substantial, rehabilitation or reconstruction is allowed only if full compliance with flood-resistant design requirements is achieved (see Section 5.1.6.2).

#### 5.2.2.1 Site Damage

The degree of site damage associated with flooding is a function of several variables related to the characteristics of the flood, as well as the site itself.

**Erosion and scour:** All parts of a school site that are subject to flooding by fast-moving water could experience erosion, and local scour could occur around any permanent obstructions to flow. Graded areas, filled areas, and cut or fill slopes are especially susceptible. Stream and channel bank erosion, and erosion of coastal shorelines, are natural phenomena that may, over time, threaten site improvements and buildings.

**Debris and sediment:** Even when buildings are not subject to water damage, floods can deposit large quantities of debris and sediment that can damage a site and be expensive to remove, especially from athletic fields.

**Landscaping:** Grass, trees, and plants suffer after floods, especially long-duration flooding that prevents oxygen uptake, and coastal flooding that stresses plants that are not salt-tolerant. Fast-moving floodwaters and waves can also uproot plants and trees.

**Fences:** Some types of fences that are relatively solid can significantly restrict the free flow of floodwaters and trap floating debris. Fences can be damaged or knocked down by the pressure of flowing water, or by the buildup of debris, which can result in significant loads.

Damage to other site elements, such as water supply, sewer lines, underground and aboveground tanks, and emergency power generators, is discussed in Section 5.2.2.5.

**Playing field surfaces:** In addition to damage by erosion and scour, graded grass fields and applied track surfaces can be damaged by standing water and deposited sediments.

**Accessory structures:** Accessory structures, such as storage sheds, bleachers, restrooms, and refreshment stands, can sustain both structural and nonstructural damage. Such structures may be designed and built using techniques that minimize damage potential, without requiring elevation above the DFE.

**Access roads:** Access roads that extend across floodprone areas can be damaged by erosion, washout of drainage culverts, failure of fill and bedding materials, and loss of road surface (see Figure 5-12). Road damage could prevent uninterrupted access to a school and thus impair its functionality.

**Parking lots:** Paved parking lots can be damaged by failure of bedding materials and loss of driving surface.

**Stormwater management facilities and site drainage:** Site improvements such as swales and stormwater basins can be eroded, filled with sediments, or clogged by debris.

**Vehicles:** If left in floodprone areas, vehicles may not be functional and available for service immediately after a flood, and must be replaced or cleaned to be serviceable (see Figure 5-13).



**Figure 5-12:**  
Flooding caused the failure of this road bed

SOURCE: U.S. ARMY CORPS OF ENGINEERS

Figure 5-13:  
School bus washed  
away by storm surge



#### 5.2.2.2 Structural Damage

Structural damage includes all damage to the load-bearing portions of a building. Local drainage systems around school buildings may be inadequate to handle high volume runoff from large expanses of pavement, sometimes resulting in water entering the buildings. Damage to other components of buildings is described below, including nonstructural components (Section 5.2.2.3), utility system equipment (Section 5.2.2.4), and contents (Section 5.2.2.5).

**Depth:** The hydrostatic load against a wall or foundation is directly related to the depth of water. Standard studs and siding, or unreinforced brick veneer walls, may collapse under hydrostatic loads associated with relatively shallow water. Reinforced masonry walls perform better than unreinforced masonry walls (see Figure 5-14); however, an engineering analysis is required to determine performance. Walls and floors of below-grade areas (basements) are particularly susceptible to damage by buoyancy forces. When soils are saturated, pressures against below-grade





**Figure 5-14:** Interior unreinforced masonry walls of the Port Sulphur High School in Louisiana were damaged by hydrostatic loads associated with Hurricane Katrina's storm surge (2005)

walls are a function of the total depth of water, including the depth below-grade, and the weight of the saturated soils.

**Buoyancy and uplift:** If below-grade areas are essentially watertight, buoyancy or uplift forces can float a building out of the ground or rupture concrete slabs-on-grade (see Figure 5-15). Buildings that are not adequately anchored can also be floated or pushed off foundations. Although rare for large and heavy school buildings, this is a concern for outbuildings and portable (temporary) classrooms. Buoyancy is a significant concern for underground and aboveground tanks, especially those used for emergency generator fuel.

**Duration:** By itself, saturation is unlikely to result in significant structural damage to masonry construction, although water infiltration through the masonry walls is likely even during short periods of inundation. Saturation of soils, a consequence of long-duration flooding, increases pressure on below-grade foundation walls.

Figure 5-15:  
Concrete slab ruptured  
by hydrostatic pressure  
(buoyancy) induced  
by the floodwaters of  
Hurricane Katrina (2005)



**Velocity, wave action, and debris impacts:** Each of these components of dynamic loads can result in structural damage if buildings are not designed to resist overturning, repetitive pounding by waves, or short-duration impact loads generated by floating debris.

**Erosion and scour:** Structural damage is associated with foundation failure when erosion or scour results in partial or complete removal of supporting soil (see Figure 5-16). Erosion of slopes, especially unprotected slopes, can lead to slope failures and loss of soils required to support foundations.

Figure 5-16:  
Scour undermined the  
foundation of St. Paul  
Catholic School, Pass  
Christian, LA.





### 5.2.2.3 Nonstructural Damage

Many floodprone buildings are exposed to floodwaters that are not fast moving, or that may be relatively shallow and not result in structural damage. Simple inundation and saturation of the building and finish materials can result in significant and costly damage, including long-term health complications associated with mold. Floodwaters often are contaminated with chemicals, petroleum products, and sewage. Under such circumstances, recovery generally involves removal of nonstructural materials and finishes because cleanup and decontamination are expensive and time-consuming. Damage to contents is described in Section 5.2.2.5.

EPA's *Mold Remediation in Schools and Commercial Buildings* (2001) offers guidelines for the remediation/cleanup of mold and moisture problems in schools and include measures designed to protect the health of building occupants and remediators. Designed primarily for use by school managers and custodians, it provides a basis for making judgments as to whether the remediation should be handled in-house. The guidance outlines mold remediation plans, whether developed by school personnel or by outside contractors.

Saturation damage can vary as a function of the duration of exposure. Some materials are not recoverable even after very brief inundation, while others remain serviceable if in contact with water for only a few hours. Use of water-resistant materials will help to minimize saturation damage and reduce the costs of cleanup and restoration to service. (For more information, see FEMA NFIP Technical Bulletin 2, *Flood Damage-Resistant Materials Requirements* [2008].)

**Wall finishes:** Painted concrete and concrete masonry walls usually resist water damage, provided the paint used can be readily cleaned. Tiled walls may resist water damage depending on the type of adhesive and foundation (gypsum board substrate and wood-framed walls with tile do not typically remain stable).

**Flooring:** Most schools have durable floors that resist water damage. Ground floors are often slab-on-grade and finished with tile or sheet products. Flooring adhesives that have been in use since the early 1990s are often latex-based and tend to break down when saturated (see Figure 5-17). Most carpeting, even the indoor-outdoor kind, is difficult to clean. Wood floors are particularly susceptible to saturation damage. Short duration inundation may not cause permanent deformation of some wood floors, such as may be present in older buildings. However, because of low tolerance for surface variations, gymnasium floors are particularly sensitive and tend to warp after flooding of any duration.

**Figure 5-17:**  
This parquet wood gymnasium floor was damaged by dimensional changes due to saturation (Hurricane Katrina 2005)



**Wall and wood components:** When soaked for long periods of time, some materials change composition or shape. Most types of wood swell when wet and, if dried too quickly, will crack, split, or warp. Plywood can delaminate and wood door and window frames may swell and become unstable. Gypsum wallboard, wood composition panels, other wall materials, and wood cabinetry not intended for wet locations can fall apart. The longer these materials are wet, the more moisture, sediment, and pollutants they absorb and the more likely that mold growth will develop. Some materials, such as the paper facing on gypsum wallboard, “wick” standing water, resulting in damage above the high-water line (see Figure 5-18).

**Metal components:** Metal structural components are unlikely to be permanently damaged by short-term inundation. However, hollow metal partitions are particularly susceptible when in contact with water because they cannot be thoroughly dried and cleaned. Depending on the degree of corrosion protection on the metal, repetitive flooding by saline coastal waters may contribute to long-term corrosion.



Figure 5-18:  
Saturation damage  
extends above the water  
line in this grade school  
in Gurnee, IL.

**Metal connectors and fasteners:** Depending on the composition of the metal, repetitive flooding, especially by saline coastal waters, may contribute to long-term corrosion. Connectors and fasteners are integral to the structural stability of buildings; therefore, failure caused by accelerated corrosion would jeopardize the building.

#### 5.2.2.4 Utility System Damage

Utility system service equipment that is exposed to flooding is vulnerable to damage. Damage may result in a total loss, or may require substantial cleaning and restoration efforts. The degree of damage varies somewhat as a function of the characteristics of flooding. Certain types of equipment and installation measures will help minimize damage and reduce the costs of cleanup and restoration to service.

**Equipment and appliances:** Installation below the flood level exposes equipment and appliances to flood forces, including drag resulting from flowing water and buoyancy. Gas-fired appliances are particularly dangerous. flotation can separate appliances from gas sources, resulting in fires and explosive situations. Displaced equipment may dislodge lines from fuel oil tanks, contributing to the threat of fire and causing water pollution and environmental damage.

**Elevators:** If located in areas subject to flooding, elevator components, equipment, and controls will be damaged, and movement between floors will be impaired.

**Metal components:** Corrosion of metal components, whether from inundation or salt aerosols in coastal areas, may not be apparent immediately but can increase maintenance demand and shorten the useful life of some equipment and appliances.

**Electrical systems and components:** Electrical systems and components, and electrical controls of heating, ventilation, and air-conditioning systems, are subject to damage simply by getting wet, even for short durations. Unless specifically designed for wet locations, switches and other electrical components can short out due to deposits of sediment, or otherwise not function, even when allowed to dry before operation. Wiring and components that have been submerged may be functional, though it is generally more cost-effective to discard flooded outlets, switches, and other less-expensive components than to attempt a thorough cleaning.

**Communications infrastructure:** Critical communications infrastructure, such as control panels and wiring for warning systems, 911 systems, and regular telephone and wireless networks, are most susceptible to failure during emergencies if located in below-grade basements.

**Ductwork:** Ductwork is subject to two flood-related problems. Flood forces can displace ductwork, and saturated insulation can overload the ductwork support straps, causing failure.

**Mold and dust:** Furnaces, air handlers, and ductwork that have been submerged must be thoroughly cleaned and sanitized. Otherwise, damp conditions contribute to the growth of mold and accumulated sediment can be circulated throughout the school, causing respiratory problems. Fiberglass batt or cellulose insulation that has been submerged cannot be sanitized and must be replaced. In sensitive environments, ductwork should be replaced rather than cleaned.

**Gas-fired systems:** Waterborne sediment can impair safe functioning of jets and controls in gas-fired furnaces and water heaters, necessitating professional cleaning and inspection prior to restoration of service. Control equipment (valves, electrical switches, relays, temperature sensors, circuit breakers, and fuses) that has been submerged may pose an explosion and fire hazard and should be replaced.

**Emergency power generators:** Generators installed at-grade are susceptible to inundation and will be out of service after a flood (see Figure 5-19). Even if fuel tanks are located above flood level, truck access for refueling would be impaired if the site is flooded for any length of time.





**Figure 5-19:** Although it was anchored and not displaced by floodwaters, this generator was out of service after being submerged (Hurricane Katrina, 2005)

**Tanks (underground):** Underground storage tanks are subjected to significant buoyant forces and can be displaced, especially when long-duration flooding occurs and the surrounding soils become saturated.

**Tanks (aboveground):** Permanently installed aboveground storage tanks are subject to buoyant forces and displacement caused by moving water. Standard strapping of propane tanks may be inadequate for the anticipated loads.

**Public utility service:** Damage to public utility service (potable water supply and wastewater collection) can affect operations and may cause damage to schools:

- Potable water supply systems may become contaminated if distribution lines or treatment facilities are damaged, or if wellheads are submerged.
- During heavy rains, sewers back up from infiltration and inflow of stormwater into the sewer lines and manholes, cross connections between storm and sanitary sewers, and flooded wastewater treatment plants. Sewer backup into a school poses a major health hazard. Even when the water has receded, exposed building components, finish materials, and contents are contaminated, and usually must be removed because adequate cleaning is difficult, if not impossible.

### 5.2.2.5 Contents Damage

Schools contain equipment and contents that can be damaged and unrecoverable when exposed to flooding. For the purpose of this description, the term “contents” includes items such as furniture, kitchen goods and equipment, computers, laboratory equipment and materials, records, and library materials. The following types of contents are often total losses after flooding.

**Furniture:** Porous woods become saturated and swollen, and joints may separate. Generally, furniture with coverings or pads cannot be restored. Metal furniture is difficult to thoroughly dry and clean, is subject to corrosion, and is typically discarded. Depending on the type of wood, some wood furniture may be recoverable after brief inundation.

**Computers:** Flood-damaged computers and peripheral equipment cannot be restored after inundation (see Figure 5-20), but special recovery procedures may be able to recover information on hard drives.

Figure 5-20:  
Destroyed computers  
and peripheral  
equipment, Nichols  
Elementary School,  
Biloxi, MS



**School records:** When offices are located in floodprone spaces, valuable school records may be lost. Although expensive, some recovery of computerized and paper records may be possible with special procedures.

**Library books and collections:** Recovery of library materials and special collections that are saturated by floodwaters is generally difficult and expensive.



**Laboratory materials and equipment:** Depending on the nature of laboratory materials, cleanup may require special procedures. Generally, equipment is difficult to restore to safe functioning.

**Kitchen goods and equipment:** Stainless steel equipment and surfaces generally have cleanable surfaces that can be disinfected and restored to service. Because of contamination, all food stuffs and perishables must be discarded.

## 5.3 Requirements and Best Practices in Flood Hazard Areas

### 5.3.1 Evaluating Risk and Avoiding Flood Hazards

**F**lood hazards are very site-specific. When a flood hazard map is prepared, lines drawn on the map appear to define the hazard area precisely. Land that is on one side of the line is “in” the mapped flood hazard area, while the other side of the line is “out.” Although the delineation may be an approximation, having hazard areas shown on a map facilitates avoiding such areas to the maximum extent practical. If those areas are unavoidable, school districts should carefully evaluate all of the benefits and all of the costs in order to determine long-term acceptable risks, and to develop appropriate plans for design and construction of new schools.

When a decision is made to build a new school on a site that is affected by flooding, the characteristics of the site and the nature of flooding must be examined prior to making several design decisions. The most important consideration is location of the buildings.

Risks and certain costs associated with flood-resistant construction are minimized by putting principal buildings on the highest available ground. Siting decisions for buildings, parking lots, and athletic fields should consider all site constraints, which may include the presence of flood hazard areas (see Table 5-3 in Section 5.6), wetlands, poor soils, steep slopes, sensitive habitats, mature tree stands, and other environmental factors as required by all applicable regulatory authorities. It should be possible to avoid siting new schools in riverine floodways and coastal areas subject to significant waves (V zones).

Section 5.2 describes the damage sustained by existing buildings exposed to flood hazards. Physical damage and loss of function are avoided if schools are located away from flood hazard areas.

Schools should not be located in V zones if alternate locations are available. Because of the effects of waves and potential for erosion and scour, construction in V zones must meet certain design and construction requirements that are different from those required in A zones. This section identifies these differences.

Flood hazard areas designated as V zones on FIRMs are relatively narrow areas along open coasts and lake shores where the base flood conditions are expected to produce 3-foot or higher waves. V zones, sometimes called coastal high hazard areas or SFHAs subject to high-velocity wave action, are found on the Pacific, Gulf, and Atlantic coasts, and around the Great Lakes. Every effort should be made to locate schools outside of V zones, because the destructive nature of waves makes it difficult to design a building to be fully functional during and after a flood event. This is particularly true in coastal areas subject to hurricane surge flooding.

### 5.3.2 Benefits and Costs: Determining Acceptable Risk

Many decisions made with respect to schools are, in part, based on a determination of acceptable risk. Risk includes the potential losses associated with a hazard. Ideally, risks can be defined in terms of expected probability and frequency of the hazard occurring, the people and property exposed, and the potential consequences.

Choosing a site or accepting donated land that is affected by flooding is a decision to accept some degree of risk. Although the floodprone land may have a lower initial cost, the incremental costs of construction, plus the likely increased costs of maintenance, repair, and replacement, may be significant. Another cost of locating a school in a floodprone area

is related to access problems if streets and access roads are impassable. The building may be elevated and protected, but if access is restricted periodically, then the use of the school is affected.

In communities with expansive flood hazard areas, there may be no practical alternatives to using a floodprone site. In these situations, an evaluation of acceptable risk should lead to selection of design measures that exceed the minimum requirements to mitigate the impacts of flooding.

Extreme hurricane storm surge flooding may be a very low-probability event, but the flood depths and wave heights may be much more severe than the conditions of the base flood shown on the FIRMs. The potential impacts on a school must be carefully considered in order to make an informed decision regarding acceptable risk and potential damage. If possible, areas subject to extreme storm surge flooding should be avoided when locating schools.

The school district's planning team and the design team can influence the degree of risk (e.g., the frequency and severity of flooding that may affect the

site). They control it through the selection of the site design and the building design measures. Fundamentally, this process is a balancing of the benefits of an acceptable level of disaster resistance with the costs of

achieving that degree of protection. With respect to mitigation of future hazard events:

- Benefits are characterized and measured as future damage avoided if mitigation measures (including avoiding flood hazard areas) are implemented.
- Costs are the costs associated with implementing measures to eliminate or reduce exposure to hazards.

Benefits other than avoided physical damage are difficult to measure. They are associated with future damage that does not occur because of the mitigation activity, cleanup that is not required because of the mitigation activity, and continued education of children because flooding does not shut down a school. In addition, benefits accrue over long periods of time, making it difficult to make a direct comparison of the benefits with the up-front costs of mitigation. Mitigation costs can be more readily expressed in terms of the higher costs of a flood-free site, or the initial capital costs of work designed to resist flood damage. Thus, without full accounting of both benefits and costs, decisionmakers may not be able to make fully informed decisions. Some questions that should be answered include:

- If the site is floodprone and the building is out of the flood hazard area or is elevated on fill, what are the average annual cleanup costs associated with removal of sand, mud, and debris deposited by floods of varying frequencies?
- If the school is elevated by means other than fill, will periodic inundation of the exposed foundation elements cause higher average annual maintenance costs?
- If the school is protected with floodproofing measures, what are the costs of annual inspection, periodic maintenance and replacement of materials, and staff training and drills?
- If the school meets only the minimum elevation requirements, what are the average annual damages and cleanup costs over the anticipated useful life of the building, including the occurrence of floods that exceed the design flood elevation?
- How do long-term costs associated with periodic inundation compare to up-front costs of selecting a different site or building to a higher level of protection?
- If a site outside of the flood hazard area is available but less than optimal in terms of access by the community, are the trade-offs acceptable?

- If the school is located in a hurricane-prone community, how should the school design account for low-probability, but high-impact, storm surge flooding?
- If access to the school is periodically restricted by flooding, especially long-duration flooding, what are the resulting cost effects? How often would the school district have to provide an alternate location to continue classes?

### 5.3.3 Site Modifications

When sites being considered for schools are determined to be prone to flooding, facility planners and designers may want to evaluate the feasibility of certain site modifications in order to provide an increased level of protection to buildings. The evaluations involve engineering analyses to determine whether the desired level of protection is cost effective, and whether the proposed site modifications alter the floodplain in ways that could increase flooding. The effectiveness of typical site modifications and their ramifications must be examined for each specific site.

**Earthen fill:** Fill can be placed in the flood hazard area to elevate an entire site above the DFE. If the fill is placed and compacted to be stable during the rise and fall of floodwaters, and if the fill is protected from erosion, then modifying a site with fill to elevate a school is preferred over other methods of elevation. Not only will buildings be less exposed to flood forces, but, under some circumstances (such as long-duration floods), schools may be able to continue to function. Whether nonstructural fill is placed solely to modify the site, or structural fill is placed to elevate buildings, placement of fill can change flooding characteristics, including increased flooding on other properties. Engineering analyses can be conducted to determine whether eliminating floodplain storage by filling will change the direction of the flow of water, create higher flow velocities, or increase the water surface elevation in other parts of the floodplain.

In Coastal A Zones, back bays, and along the banks of wide rivers where wave action is anticipated, fill is a less-effective site modification method because wave action may erode the fill, and adequate armoring or other, protection methods can be expensive.

In V zones, structural fill is not allowed as a method of elevating buildings. Beachfront areas with sand dunes pose special problems. Manmade alterations of sand dunes are not allowed unless analyses indicate that such modifications will not increase potential flood damage.

**Excavation:** Excavation on a given parcel of land alone rarely results in significant alteration of the floodplain. Excavation that modifies a site is more commonly used in conjunction with fill in order to offset or compensate for the adverse impacts of fill.

**Earthen levee:** A levee is a specially designed barrier that modifies the floodplain by keeping the water away from certain areas (see Figure 5-21a). Levees are significant structures that require detailed, site-specific geotechnical investigations; engineering analyses to identify whether flooding will be made worse on other properties; structural and site design to suit existing constraints; design of interior drainage (on the land side); and long-term commitment for maintenance, inspection, and repairs. Areas behind levees are protected only up to a certain design flood level—once overtopped or breached, most levees fail and catastrophic flooding results. Levees that protect schools and other critical facilities usually are designed for at least the 0.2-percent-annual-chance flood (500-year) and have freeboard to increase the factor of safety. Depending on the site layout and duration of flooding, access for vehicles can be problematic. Low levees can be designed with road access; higher levees can be designed with vehicle access points that require special closures when flooding is predicted.

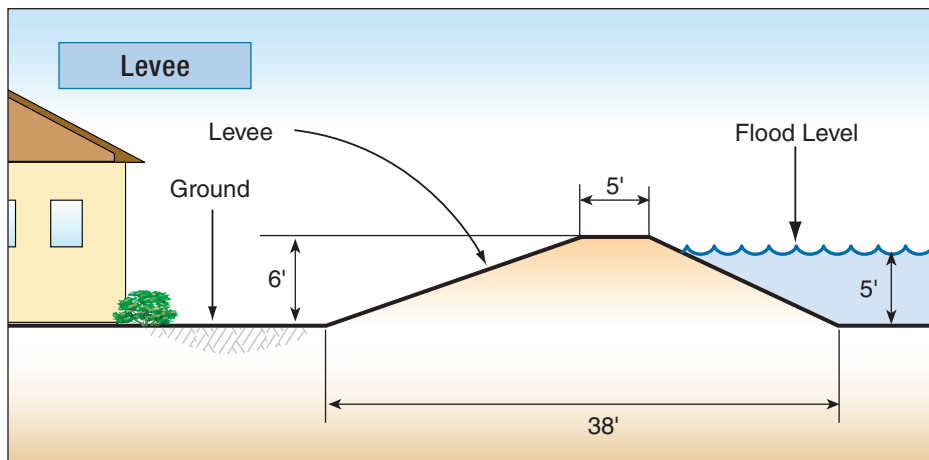
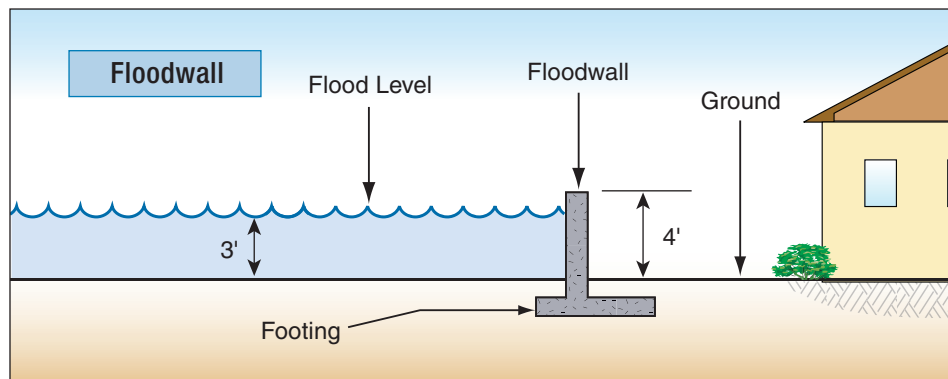

Figure 5-21a:  
Schematic of typical  
earthen levee

**Floodwall:** Floodwalls are similar to levees in that they provide protection to certain areas (see Figure 5-21b). Failure or overtopping of a floodwall can result in catastrophic flooding. A floodwall is a significant structure designed to hold back water of a certain depth based on the design flood for the site. Generally, floodwalls are most effective in areas with relatively shallow flooding and minimal wave action. As with levees, designs must accommodate interior drainage on the land side, and maintenance

and operations are critical for adequate performance. Floodwalls that protect buildings that provide essential services usually are designed for the 0.2-percent-annual-chance flood (500-year) and have freeboard to increase the factor of safety. If a protected school is intended to remain operational during long-duration flooding, vehicle access to the site and pedestrian access to the building are required.

Figure 5-21b:  
Schematic of typical permanent floodwall



### 5.3.4 Elevation Considerations

The selection of the appropriate method of elevating a school building in a SFHA depends on many factors, including type of flood zone, costs, level of safety and property protection determined as acceptable risk, and others. Another consideration is the elevation of the lowest floor relative to the flood elevation. Table 5-1 in Section 5.1.6.4 summarizes the elevation requirements in ASCE 24. Given the importance of schools, elevation of the lowest floor to or above the 0.2-percent-annual-chance flood (500-year) elevation should be considered the minimum. Various methods used to elevate buildings in flood hazard areas are described below.

In A zones, the minimum requirement is that the lowest floor (including the basement) be at or above the DFE (plus freeboard, if desired or required). For building elevation methods other than fill, the area under elevated buildings in A zones may be used only for limited purposes: parking, building access, and limited storage (crawlspaces are treated as enclosures, see below). Facility planners and designers are cautioned that enclosures below the DFE are exposed to flooding and the contents will be damaged or destroyed by floodwaters. The walls surrounding an enclosure must have flood openings that are intended to equalize

**“Lowest floor”** is the floor of the lowest enclosed area (including the basement). An unfinished or flood-resistant enclosure, usable solely for parking of vehicles, building access, or storage in an area other than a basement, is not the lowest floor, provided the enclosure is built in compliance with applicable requirements.



interior and exterior water levels in changing flood conditions, to prevent differential hydrostatic pressures leading to structural damage. The enclosed area must not contain utilities and equipment (including ductwork) below the required elevation.

In V zones, the minimum requirement is that the elevation of the bottom of the lowest horizontal structural member of the lowest floor (including basement) be at or above the DFE (plus freeboard, where required). (Use of structural fill to achieve elevation is not allowed and dry floodproofing is not allowed.) Given the importance of schools, elevation to or above the 0.2-percent-annual-chance flood (500-year) elevation is appropriate and strongly recommended. The V zone requirements are recommended in Coastal A Zones.

The area under elevated buildings in V zones may be used only for parking, building access, and limited storage. The areas may be open or enclosed by lattice walls or screening. If areas are enclosed by solid walls, the walls must be specifically designed to break away under certain flood loads to allow the free passage of floodwaters under the building. Breakaway walls are non-load-bearing walls, i.e., they do not provide structural support for the building. They must be designed and constructed to collapse under the pressure of floodwaters in such a way that the supporting foundation system and the structure are not affected.

Coastal communities along the Atlantic and Gulf coasts are subject to storm surge flooding generated by hurricanes and tropical storms. Depending on a number of variables, storm surge flood depths may significantly exceed the BFE. In addition, waves are likely to be higher than predicted for the base flood, and will occur farther inland in areas where significant wave action during the base flood is not expected. Application of the minimum requirements related to elevation of the lowest floor and foundation design does not result in flood resistance for such extreme conditions. Foundations for schools in areas subject to storm surge should be designed to elevate the building so that the lowest horizontal structural members are higher than the minimum required elevation. Additional elevation not only reduces damage that results from lower probability events, but the cost of Federal flood insurance is usually lower. Facility planners and designers should plan to use the lowest elevated floor for non-critical uses that, even if exposed to flooding

Communities that participate in the NFIP require that a registered professional engineer or architect develop or review the structural design, specifications, and plans, and certify that the dry floodproofing design and methods of construction to be used are in accordance with accepted standards of practice. The standards of practice require that the building, together with attendant utility and sanitary facilities, be designed so that it is watertight, with walls substantially impermeable to the passage of water and with structural components having the capability of resisting hydrostatic and hydrodynamic loads and effects of buoyancy associated with the design flood event.

more severe than the design flood, will not impair critical functioning during post-flood recovery.

Storm surge flooding and waves can cause scour and erosion, even at locations that are some distance from the shoreline. Foundation designs for schools in coastal communities should account for some erosion and local scour of supporting soil during low-probability surge events. Storm surge flooding can also produce large quantities of floating debris, even at locations that are some distance from the shoreline. Debris can damage nonstructural building components and, in some cases of prolonged battering, can lead to structural failure. Foundation designs for schools in coastal communities should account for debris loads. This is especially important where damage to other buildings in the area may generate additional debris, thereby increasing the loads.

**Notes on continuous load path:** In coastal communities and other areas exposed to high winds, designers should pay special attention to the entire roof-to-foundation load path when designing and specifying connections. Connections must be capable of withstanding simultaneous wind and flood forces. Poorly connected buildings may fail or float off foundations when floodwaters and waves are higher than the design flood elevation. Corrosion-resistant connections are critical for the long-term integrity of the structure, and should be inspected and maintained regularly.

**Slab-on-grade foundation on structural fill:** This is considered to be the safest method to elevate a building in many flood hazard areas, except those where waves and high velocity flows may cause erosion. Consequently, this foundation type is not allowed in V zones. Structural fill can be placed so that even if water rises up to the DFE, the building (see Figure 5-22) and building access would still be protected from flooding. The fill must be designed to minimize adverse impacts, such as increasing flood elevations on adjacent properties, increasing erosive velocities, and causing local drainage problems. To ensure stability, especially as floodwaters recede and the soils drain, fill must be designed for the anticipated water depths and duration. A geotechnical engineer or soil scientist may need to examine underlying soils to determine if the bearing capacity is sufficient to carry the added weight of fill, or if consolidation over time may occur. In addition, the effects of long-term compaction of the fill should be considered, and may prompt additional elevation as a factor of safety. The horizontal extent of the fill, away from the foundation, should be designed to facilitate access by emergency vehicles, with a minimum 25-foot width recommended. Engineered concrete slabs supported by piers should have sufficient resistance to erosion and scour if designed for anticipated flood conditions. Designers are cautioned to avoid excavating

a basement into fill without added structural protection (and certification that the design meets the requirements for dry floodproofing), due to the potential for significant hydrostatic loads and uplift on basement floors.



Figure 5-22:  
High school in  
Bloomsburg, PA,  
elevated on fill

**Stem wall foundations:** Stem wall foundations have a continuous perimeter grade beam, or perimeter foundation wall, that is backfilled with compacted earth to the underside of the concrete floor slab (see Figure 5-23). This foundation type is not allowed in V zones. Stem wall foundations are designed to come in contact with floodwaters on the exterior. They are more stable than perimeter wall foundations with crawlspaces, but could experience structural damage if undermined by local scour and erosion. Designs must account for anticipated debris and ice impacts, and incorporate methods and materials to minimize impact damage.

**Columns or shear wall foundations (open foundations):** Open foundations consist of vertical load-bearing members (columns, piers, pilings, and shear walls) without solid walls connecting the vertical members. Open foundations minimize changes to the floodplain and local drainage patterns, and the area under the building can be used for parking or student activities (see Figure 5-24). The design of the vertical members must also account for hydrodynamic loads and debris and ice impact loads. Flood loads on shear walls are reduced if they are oriented parallel to the anticipated direction of flow. If erodible soils are present and local scour is likely, both conditions must be taken into account when determining embedment depth of the vertical foundation members. Depending on the total height of the elevated school, the design may need to take into consideration the increased exposure to wind and uplift, particularly where loads are expected from breaking waves.



Figure 5-23:  
A stemwall foundation  
elevates the Marion  
T. Academy above  
the flood level in  
Wilmington, DE.



Figure 5-24:  
School elevated on  
columns



In V zones, buildings must be elevated using open foundations, which consist of vertical load-bearing members (columns, piers, pilings, and shear walls) without solid walls connecting the vertical members. The design of the vertical members must also account for hydrodynamic loads and debris impact loads. Flood loads on shear walls are reduced if the walls are oriented parallel to the anticipated direction of flow. Erodible soils may be present and local scour may occur; both must be accounted for in designs by extending the load-bearing members and foundation elements well below the expected scour depth.

**Continuous perimeter walls (enclosed foundations with crawlspace):** Unlike stem wall foundations, continuous perimeter walls enclose an open area or crawlspace (see Figure 5-25). The perimeter walls must have flood openings, also called vents) that are intended to equalize interior and exterior water levels automatically during periods of rising and falling flood levels, to prevent differential hydrostatic pressures that could lead to structural damage. Flood openings may be engineered and certified for the required performance, or they must meet prescriptive requirements (notably, the opening must provide at least 1 square inch of net open area for each square foot of area enclosed). Perimeter wall design must also account for hydrodynamic loads, and debris and ice impact loads. Enclosed crawlspaces must not contain utilities or equipment

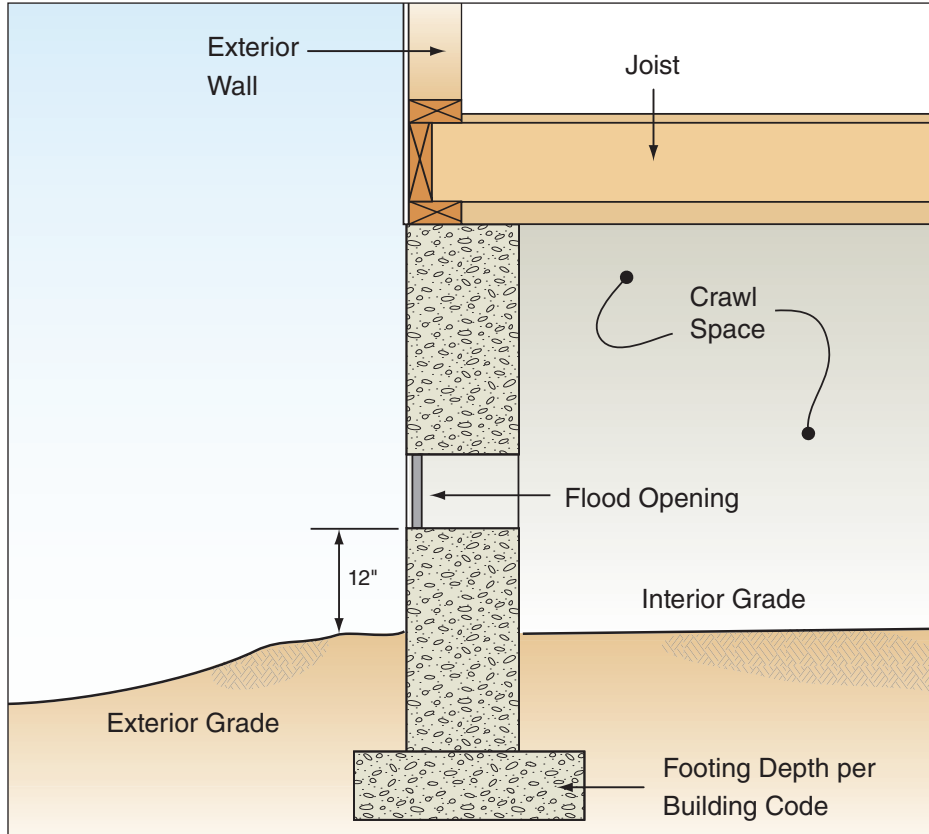

Figure 5-25:  
Typical crawlspace with  
flood openings

(including ductwork) below the required elevation. Designers must provide adequate under-floor ventilation and subsurface drainage to minimize moisture problems after flooding. This foundation type is not allowed in V zones.

**Pier supports for manufactured and portable units:** Manufactured buildings and portable units must be elevated above the DFE (plus freeboard, if required). Pier supports must account for hydrodynamic loads and debris and ice impact loads, and units must be anchored to resist wind loads. Although written specifically for manufactured housing units, FEMA P-85, *Protecting Manufactured Homes from Floods and Other Hazards. A Multi-Hazard Foundation and Installation Guide* (2009b), has useful information that is applicable to portable units.

### 5.3.5 Dry Floodproofing Considerations

Dry floodproofing involves a combination of design and special features that are intended both to prevent water infiltration and resist flood forces. It involves structural reinforcement so that exterior walls are sufficiently robust to withstand the loads described in Section 5.1.3 (hydrostatic pressure, hydrodynamic loads, wave loads, and debris impact loads). Exterior walls must also be designed to prevent infiltration and seepage of water, whether through the wall itself or through any openings, including where utility lines penetrate the envelope. Floodproofing techniques are considered to be permanent measures if they are always in place and do not require occupants to take any specific actions to be effective. An alternative to reinforcement of a structure's walls involves the installation of a permanent floodwall that is slightly offset from the exterior of the structure, but designed to be integral to the foundation.

Communities that participate in the NFIP require that a registered professional engineer or architect develop or review the structural design, specifications, and plans, and certify that the dry floodproofing design and methods of construction to be used are in accordance with accepted standards of practice. The standards of practice require that the building, together with attendant utility and sanitary facilities, be designed so that it is watertight, with walls substantially impermeable to the passage of water and with structural components having the capability of resisting hydrostatic and hydrodynamic loads and effects of buoyancy associated with the design flood event.

According to the model building codes and the NFIP regulations, non-residential buildings and nonresidential portions of mixed-use buildings in A zones may be dry floodproofed. Although floodproofing is allowed, careful consideration must be given to the possible risks to occupants and additional physical damage before a decision is made to construct a new school using floodproofing methods. Dry floodproofing is not allowed in V zones.

All flood protection measures are designed for certain flood conditions. Considering the possibility that the design conditions can be exceeded (i.e., water can rise higher than the protective structures),



a dry floodproofed building may, in such circumstances, sustain catastrophic damage. As a general rule, dry floodproofing is a poor choice for new schools when avoidance of the floodplain or elevation methods to raise the building above the flood level can be applied. Floodproofing may be acceptable for retrofitting existing buildings under very limited circumstances (see Section 5.4.5).

A number of dry floodproofing limitations and requirements are specified in ASCE 24:

- Dry floodproofing is limited to areas where flood velocities at the site are less than or equal to 5 feet per second.
- If human intervention is required to deploy measures to protect doors and windows, the flood warning time shall be a minimum of 12 hours unless the community operates a flood warning system and implements a notification procedure that provides sufficient time to undertake these measures.
- At least one door satisfying building code requirements for an exit door or primary means of escape must be provided above the level of protection.
- An emergency plan, approved by the community and posted in at least two conspicuous locations, is required in floodproofed buildings; the plan is intended to specify the location of panels and hardware, methods of installation, conditions that activate deployment, a schedule for routine maintenance of any aspect that may deteriorate over time, and periodic practices and drills.

Windows, doors, and other openings that are below the flood level used for dry floodproofing design present significant potential failure points. They must be specially designed units (see Figure 5-26) or be fitted with gasketed, mountable panels that are designed for the anticipated flood conditions and loads. Generally speaking, protecting window and door openings from water more than a few feet deep is difficult. The framing and connections must be specifically designed for these protective measures, or water pressure may cause window and door frames to separate from the building.

Dry floodproofing is required to extend to 1 or 2 feet above the DFE (see Table 5-1). For the purpose of obtaining NFIP flood insurance, the floodproofing must extend at least 1 foot above the BFE, or the premiums will be very high. A higher level of protection is recommended.

Although dry floodproofing of facilities in Coastal A Zones is allowed by the NFIP, designs that comply with the IBC must take into consideration the additional forces associated with wave impacts, which may make dry floodproofing a less feasible alternative.

Figure 5-26:  
Specially designed  
panels are mounted to  
block doors, windows,  
and other openings  
to keep water from  
entering the building.



Dry floodproofed schools must never be considered safe for occupancy during periods of high water; floodproofing measures are intended only to reduce physical damage.

Floodproofing techniques are considered to be permanent measures if they are always in place and do not require any specific human intervening action to be effective. Use of contingent floodproofing measures that require installation or activation, such as window shields or inflatable barriers, may significantly reduce the certainty that floodproofing will be effective. Rigorous adherence to a periodic maintenance plan is critical to ensure proper functioning. If these measures are used to protect schools, the school's management must have a formal, written plan, and the people responsible for implementing the measures must be informed and trained. These measures also depend on the timeliness and credibility of the warning. In addition, floodproofing devices often rely on flexible seals that require periodic maintenance and that, over time, may deteriorate and become ineffective. Therefore, a maintenance plan must be developed and a rigorous annual inspection and training must be conducted.

Safety of occupants is a significant concern with dry floodproofed buildings, because failure or overtopping of the floodproofing barriers is likely to cause catastrophic structural damage. When human intervention is required for deploying of barriers, those responsible for implementing the measures remain at risk while at the school, even if a credible warning system is in place, because of the many uncertainties associated with predicting the onset of flood conditions.

### 5.3.6 Flood Damage-Resistant Materials

All structural materials, nonstructural materials, and connectors that are used below certain elevations (see Table 5-1) are to be flood resistant. Flood-damage-resistant materials have sufficient strength, rigidity, and durability to adequately resist flood loads and damage due to saturation. They are building materials that are capable of withstanding direct and prolonged contact with floodwaters without sustaining any damage that requires more than cosmetic repair. As defined in ASCE 24, the term “prolonged contact” means partial or total inundation by floodwaters for 72 hours for non-coastal areas (fresh water) or 12 hours for coastal areas.

In general, materials that are exposed to floodwaters are to be capable of resisting damage, deterioration, corrosion, or decay. Typical construction materials range from highly resistant to not at all resistant to water damage. FEMA NFIP Technical Bulletin 2 contains tables with building materials, classified based on flood resistance (Table 5-2).

Table 5-2: Classes of flood damage-resistant materials

NFIP	Class	Class Description
Acceptable	5	<b>Highly resistant to floodwater<sup>1</sup> damage, including damage caused by moving water.<sup>2</sup></b> These materials can survive wetting and drying and may be successfully cleaned after a flood to render them free of most harmful pollutants. <sup>3</sup> Materials in this class are permitted for partially enclosed or outside uses with essentially unmitigated flood exposure.
	4	<b>Resistant to floodwater<sup>1</sup> damage from wetting and drying, but less durable when exposed to moving water.<sup>2</sup></b> These materials can survive wetting and drying and may be successfully cleaned after a flood to render them free of most harmful pollutants. <sup>3</sup> Materials in this class may be exposed to and/or submerged in floodwaters in interior spaces and do not require special waterproofing protection.
Unacceptable	3	<b>Resistant to clean water<sup>4</sup> damage, but not floodwater damage.</b> Materials in this class may be submerged in clean water during periods of flooding. These materials can survive wetting and drying, but may not be able to be successfully cleaned after floods to render them free of most <sup>3</sup> harmful pollutants.
	2	<b>Not resistant to clean water<sup>4</sup> damage.</b> Materials in this class are used in predominantly dry spaces that may be subject to occasional water vapor and/or slight seepage. These materials cannot survive the wetting and drying associated with floods.
	1	<b>Not resistant to clean water<sup>4</sup> damage or moisture damage.</b> Materials in this class are used in spaces with conditions of complete dryness. These materials cannot survive the wetting and drying associated with floods.

**Notes:**

1. Floodwater is assumed to be considered “black” water; black water contains pollutants such as sewage, chemicals, heavy metals, or other toxic substances that are potentially hazardous to humans.
2. Moving water is defined as water moving at low velocities of 5 feet per second (fps) or less. Water moving at velocities greater than 5 fps may cause structural damage to building materials.
3. Some materials can be successfully cleaned of most of the pollutants typically found in floodwater. However, some individual pollutants such as heating oil can be extremely difficult to remove from uncoated concrete. These materials are flood damage-resistant except when exposed to individual pollutants that cannot be successfully cleaned.
4. Clean water includes potable water as well as “gray” water; gray water is wastewater collected from normal uses (laundry, bathing, food preparation, etc.).

SOURCE: FLOOD DAMAGE-RESISTANT MATERIALS REQUIREMENTS, FEMA-TB-2, AUGUST 2008.

FEMA NFIP Technical Bulletin 2, *Flood Damage-Resistant Materials Requirements* (2008), provides some additional information. Many types of materials and application products are classified by degrees of resistance to flood.

In coastal areas, airborne salt aerosols and inundation with saline water increase the potential for corrosion of some metals. Structural steel and other metal components that are exposed to corrosive environments should be stainless steel or hot-dipped galvanized after fabrication.

In areas away from the coast, exposed structural steel should be primed, coated, plated, or otherwise protected against corrosion. Secondary components such as angles, bars, straps, and anchoring devices, as well as other metal components (plates, connectors, screws, bolts, nails angles, bars, straps, and the like) should be stainless steel or hot-dipped galvanized after fabrication.

Concrete and masonry that are designed and constructed in compliance with applicable standards are generally considered to be flood resistant. However, masonry facings are undesirable finishes unless extra anchoring is added to prevent separation (see Figure 5-27). Wood and timber members exposed to floodwaters should be naturally decay-resistant species, or should be pressure treated with appropriate preservatives.

**Figure 5-27:**  
Brick facing separated from masonry wall  
(Hurricane Katrina, 2005)





### 5.3.7 Access Roads

Roads and entrances leading to schools should be designed to provide safe access at all times, to minimize impacts on flood hazard areas, to minimize damage to the road itself, and to minimize exposing vehicles to dangerous situations. Even if the school is elevated and protected from flood damage, when access is impaired, functionality is also impaired. Facility planners and designers should take the following factors into consideration.

**Safety factors:** Although a school's access road off the primary surface street may not be required to carry regular traffic like other streets, a floodprone road always presents a degree of risk to public safety. To minimize those risks, some State or local regulatory authorities require that access roads be designed so that the driving surface is at the DFE, or no more than 1 to 2 feet below the DFE. At a minimum, a school's access road should be at least as high as the adjacent public road, so that the same level of access is provided during conditions of flooding. To maximize evacuation safety, two separate access roads to different feeder roads are recommended. In some circumstances, especially long-duration flooding where a school is built on fill, access roads designed to be above flood levels would help the school to continue its operations.

**Floodplain impacts:** Engineering analyses may be required to determine the effects on flood elevations and flow patterns if large volumes of fill are required to elevate a road to minimize or eliminate flooding above the driving surface.

**Drainage structure and road surface design:** The placement of multiple drainage culverts, even if not needed for local drainage, can facilitate the passage of floodwaters and minimize the potential for a road embankment to act as a dam. Alternatively, an access road can be designed with a low section over which rising floodwater can flow without washing out the roadbed. Embankments should be designed to remain stable during high water and as waters recede. They should be sloped and protected to resist erosion and scour. Similarly, the surface and shoulders of roads that are intended to flood should be designed to resist erosion. The increased resistance to erosion may be accomplished by increasing the thickness of the road base.

### 5.3.8 Utility Installations

Utilities associated with new schools in flood hazard areas must be protected either by elevation or special designs and installation measures. Utilities subject to this provision include all systems, equipment, and fixtures, including mechanical, electrical, plumbing, heating, ventilating,

and air-conditioning. Potable water systems (wellheads and distribution lines) and wastewater collection lines are addressed in Section 5.3.9.

Utility systems and equipment are best protected when elevated above the DFE (plus freeboard, if required). Equipment that is required for emergency functioning during or immediately after an event, such as emergency generators and fuel tanks, is best installed well above the DFE. In some cases, equipment can be located inside protective floodproofed enclosures, although if flooding exceeds the design level of the enclosure, the equipment would be adversely affected (see Figure 5-28). Designers should pay particular attention to under-floor utilities and ductwork to ensure that they are properly elevated. Plumbing conduits, water supply lines, gas lines, and electric cables that must extend below the DFE should be located, anchored, and protected to resist the effects of flooding. Equipment that is outside of an elevated building also must be elevated:

- In A zones, equipment may be affixed to raised support structures or mounted on platforms that are attached to or cantilevered from the primary structure.

For more information on utility installations, see FEMA 348, *Protecting Building Utilities from Flood Damage: Principles and Practices for the Design and Construction of Resistant Building Utility Systems* (1999).

**Figure 5-28:**  
Equipment room with  
watertight door

SOURCE: PRESRAY  
CORPORATION





- In V zones and Coastal A Zones, equipment may be affixed to raised support structures designed for the flood conditions (waves, debris impact, erosion, and scour) or mounted on platforms that are attached to or cantilevered from the primary structure. If an enclosure is constructed under the elevated building, the designer must take care that utilities and attendant equipment are not mounted on or do not pass through walls that are intended to break away.

Although it is difficult to achieve, the model building codes and NFIP regulations provide an alternative that allows equipment to be located below the DFE. This alternative requires that such equipment be designed, constructed, and installed to prevent floodwaters from entering or accumulating within the components during flood events.

### 5.3.9 Potable Water and Wastewater Systems

New installations of potable water systems and wastewater collection systems are required to resist flood damage, including damage associated with infiltration of floodwaters and discharge of effluent. Health concerns arise when water supply systems are exposed to floodwaters. Contamination from flooded sewage systems poses additional health and environmental risks. Onsite water supply wellheads should be located on land elevated from the surrounding landscape to allow contaminated surface water and rainfall-runoff to drain away. Well casings should extend above the DFE, and casings should be sealed with a tight-fitting, floodproof, and vermin-proof well cap. The space between the well casing and the side of the well must be sealed to minimize infiltration and contamination by surface waters.

Sewer collection lines should be located and designed to avoid infiltration and backup due to rising floodwaters. Devices designed to prevent backup are available and are recommended to provide an added measure of protection.

Onsite sewage systems usually are not used as the primary sewage disposal systems for new schools. However, facility planners and designers should consider a backup onsite system if a school's functionality can be impaired when the public system is affected by flooding. Local or State health departments may impose constraints that limit or prevent locating septic fields in floodplain soils or within a mapped flood hazard area. If allowed, septic fields should be located on the highest available ground to minimize inundation and damage by floodwaters. An alternative to a septic field is installation of a holding tank that is sized to contain wastewater for a period of time, perhaps a few days, while the municipal system is out of service.

### 5.3.10 Storage Tank Installations

Aboveground and underground storage tanks located in flood hazard areas must be designed to resist flotation, collapse, and lateral movement. ASCE 24 specifies that aboveground tanks be elevated or constructed, installed, and anchored to resist at least 1.5 times the potential buoyant and other flood forces under design flood conditions, assuming the tanks are empty. Similarly, underground tanks are to be anchored to resist at least 1.5 times the potential buoyant forces under design flood conditions, assuming the tanks are empty. In all cases, designers are cautioned to address hydrodynamic loads and debris impact loads that may affect tanks that are exposed to floodwaters. Vents and fill openings or cleanouts should be elevated above the DFE or designed to prevent the inflow of floodwaters or outflow of the contents of tanks.

### 5.3.11 Accessory Structures

Many school campuses have multiple buildings. All buildings, including those that are accessory to the primary building, must be designed and constructed in full compliance with floodplain management regulations. Portable classrooms are not accessory structures. Bleachers are allowed provided they are anchored to resist flood forces.

In flood hazard areas designated as A zones, some minor accessory structures used only for storage and parking need not fully comply, but may be “wet floodproofed” using techniques that allow them to flood while minimizing damage. Accessory structures must be anchored to resist flotation, collapse, and lateral movement. Flood-resistant materials must be used and utilities must be elevated above the DFE (plus freeboard, if required). If fully enclosed by walls, the walls must have flood openings to allow the free inflow and outflow of floodwaters to minimize the hydrostatic loads. Because wet floodproofed accessory buildings are designed to flood, school staff must be aware that contents will be damaged.

Accessory structures on school campuses that are located in V zones must be elevated and otherwise comply with the applicable requirements.

## 5.4 Risk Reduction for Existing Schools

### 5.4.1 Introduction

**S**ection 5.2 describes damage that can be sustained by schools that already are located in flood hazard areas. The vulnerability of these facilities can be reduced if they can be made more resistant to flooding. School districts may take such action when flood hazards are identified and there is a desire to undertake risk reduction measures

proactively. Interest may be prompted by a flood or by the requirement to address flood resistance as part of a proposed addition or substantial improvement of the existing building. The checklist in Section 5.6 includes some questions and guidance intended to help identify building characteristics of importance when considering risk reduction measures for existing facilities.

Work performed on existing school buildings and outbuildings is subject to codes and regulations, and the appropriate regulatory authority with jurisdiction should be consulted. With respect to reducing flood risks, work generally falls into the categories described in the following subsections.

### 5.4.2 Site Modifications

Modifying the site of an existing school property that is subject to flooding requires careful examination by an experienced professional engineer. Determining the suitability of a specific measure requires a complex evaluation of many factors, including the nature of flooding and the nature of the site. The first part of Table 5-3 in Section 5.6 identifies elements that influence the choice of mitigation measures applicable to existing sites. Some flood characteristics may make it infeasible to apply site modification measures to existing schools (e.g., depths greater than 3 to 4 feet, very high velocities, insufficient warning because of flash flooding or rapid rate of rise, and very long duration). In Coastal A Zones, wave conditions must be accounted for in design of site modifications. Such modifications are not allowed in V zones.

A common problem with all site modifications is the matter of access. Depending on the topography of the site, construction of barriers to floodwaters may require special access points. Access points may be protected with manually installed stop-logs or designed gates that drop in, slide, or float into place. Whether activated by automatic systems or manually operated, access protection requires sufficient warning time.

Other significant constraining factors include poor soils and insufficient land area, which can make site modifications either infeasible or very costly. For any type of barrier, rainfall that collects on the dry side must be accounted for in the design, whether through adequately sized storm-water storage basins set aside for this purpose, or

School districts should be aware of the importance of flood insurance coverage for structures that are located in the flood hazard areas shown on NFIP maps. If not insured for flood peril, the amount of flood insurance that should have been in place will be deducted from any Federal disaster assistance payment that would otherwise have been made available. A district may have to absorb up to \$1 million in un-reimbursable flood losses per building, because the NFIP offers \$500,000 in building coverage and \$500,000 in contents coverage for nonresidential buildings (coverage limits as of early 2010).

Schools protected by local berms, levees, and floodwalls should never be occupied during flood conditions. The consequences of failure or flood levels overtopping these measures can be catastrophic and create high-risk conditions.

by providing large-capacity pumps to move collected drainage to the water side of the barrier.

Each of the site modification measures described below has limitations, including the fact that floods larger than the design flood will exceed the level of protection.

**Site regrading (berm):** Regrading of the site, or the construction of an earthen berm, may provide adequate protection for situations in which a school is exposed to relatively shallow flooding, and sufficient land area is available.

**Earthen levee:** Earthen levees are engineered structures that are designed to keep water away from certain areas and buildings. Hydraulic analyses and geotechnical investigations are required to determine their feasibility and effectiveness. The use of earthen levees to protect existing schools is constrained by the availability of land (levees have a large “footprint” and require large land areas), cost (including availability of suitable fill material and long-term maintenance), and access difficulties. Locating levees and floodwalls within a designated floodway is generally not allowed. Rapid onset flooding makes it impractical to design a flood levee with access points that require installation of a closure system. Additionally, high velocity flows can cause erosion and reduce the stability of earthen levees.

**Permanent floodwall:** Floodwalls are freestanding, permanent engineered structures designed to prevent encroachment of floodwaters. Typically, a floodwall is located some distance from a building, so that structural modification of the existing building is not required. Depending on the topography of the site, floodwalls may protect only the low side (in which case they must “tie” into high ground) or completely surround a site (which may affect access because special closure structures are required and must be installed before the onset of flooding, see Figure 5-29).

**Mobilized floodwall:** This category of flood protection measures includes fully engineered flood protection structures that have permanent features (foundation and vertical supports) and features that require human intervention when a flood is predicted (horizontal components called planks or stop-logs). Mobilized floodwalls have been used to protect entire sites, or to tie into permanent floodwalls or high ground. Because of the manpower and time required for proper placement, these measures are better suited to conditions that allow long warning times.



**Figure 5-29:**  
A masonry floodwall  
with multiple engineered  
openings in Fargo, ND,  
during flooding in 2001

SOURCE: FLOOD CONTROL  
AMERICA, LLC

### 5.4.3 Additions

Model building codes generally treat additions as new construction, and thus additions to schools in flood hazard areas should be elevated or dry floodproofed to minimize exposure to flooding. However, full compliance with the code and NFIP requirements is only required if an addition is a substantial improvement (i.e., the cost of the addition plus all other costs associated with the work equal or exceed 50 percent of the market value of the building, see Section 5.1.6.1 and Section 5.1.6.2). Designers are cautioned that even the existing buildings may be required to comply with the flood-resistant provisions of the code or local ordinances, if the addition is structurally connected to the existing building and is determined to be a substantial improvement.

Section 5.3.4 outlines foundation methods used to elevate buildings that also are applicable to additions. Elevation of an addition on fill may not be feasible unless structural fill can be placed adjacent to the existing building. Utility service equipment for additions must meet the requirements for new installations (see Section 5.3.8).

If an evaluation determines that dry floodproofing is appropriate, additions may be floodproofed (see Section 5.3.5). To provide adequate protection for the addition, floodproofing must be applied to all exterior walls and the wall adjoining the existing building. Openings, including doors between the addition and existing building, must also be protected.



For more information on additions and substantial improvements, see FEMA P-758, *Substantial Improvement/Substantial Damage Desk Reference* (2010) and FEMA 213, *Answers to Questions About Substantially Damaged Buildings* (1991).

With respect to code compliance and designing additions to resist flood damage, one of the more significant issues to be considered is ease of access. If the lowest floor of the existing school building is below the DFE, steps, ramps, or elevators will be required for the transition to the new addition. Some jurisdictions may contemplate allowing variances to the requirement that additions be elevated.

However, because alternative means of access are available, such as ramps and elevators it would be difficult for an applicant to demonstrate that there are unique limitations of the site and hardship that make compliance with the regulation infeasible.

#### 5.4.4 Repairs, Renovations, and Upgrades

Every school considered for upgrades and renovations, or being repaired after substantial damage from any cause, must be examined for structural integrity and stability to determine compatibility with structural modifications that may be required to achieve acceptable performance. When an existing school is located in a flood hazard area, that examination should include consideration of measures to improve resistance to flood damage and to reduce risks.

The model building codes and the NFIP regulations require that work constituting “substantial improvement” of an existing building be in compliance with the flood-resistant provisions of the code. Non-substantial improvements should take into account measures to reduce future flood damage, such as those described in Section 5.3, emergency measures (see Section 5.4.10), and wet floodproofing measures that allow water to enter the building to avoid structural damage.

Additional information on rehabilitation of existing buildings is provided in: *Flood Proofing: How to Evaluate Your Options* (USACE, 1993), FEMA 102, *Floodproofing Non-Residential Structures* (1986), FEMA TB-3, *Floodproofing—Requirements and Certification* (1993), and FEMA 259, *Engineering Principles and Practices for Retrofitting Flood Prone Buildings* (2001). Although written primarily for homes, this last reference contains very detailed checklists and worksheets that can be modified. They also provide some guidance for evaluating the costs and benefits of various measures.

Compliance with flood-resistant provisions means that the existing building must be elevated or dry floodproofed. Both options can be difficult for existing schools, given the typical use, size, and complexity of many school buildings. Retrofit dry floodproofing (described in Section 5.4.5) is generally feasible only in areas where flood depths of 3 feet or less are expected, provided an assessment by a qualified design professional determines that the building is capable of resisting the anticipated loads, or can be modified to provide that level of performance.

Elevating an existing building presents an entirely different set of challenges and also requires detailed structural engineering analyses. It involves the same equipment and methods used to move other types of buildings; expert building movers have successfully moved large, heavy, and complex buildings, sometimes by segmenting them. A building that is elevated in-place must meet the same performance standards set for new construction.

### 5.4.5 Retrofit Dry Floodproofing

Modification of an existing building may be required or desired in order to address exposure to design flood conditions. Modifications that may be considered include construction of a reinforced supplementary wall, measures to counter buoyancy (especially if there is below-grade space), installation of special watertight door and window barriers and watertight seals around the points of entry of utility lines. The details of structural investigations and structural design of such protection measures are beyond the scope of this manual.

**“Dry floodproofing”** refers to measures and methods to render a building envelope substantially impermeable to floodwater.

Retrofit dry floodproofing is difficult to apply to existing buildings and, in general, is limited to situations where the anticipated flood depths are only 3 or 4 feet. Because of the tremendous flood loads that may be exerted on a building not originally designed to keep water out, detailed structural engineering evaluations are required to determine whether an existing building can be dry floodproofed. The following elements must be examined:

- The strength of the structural system
- Whether non-load bearing walls can resist anticipated flood loads; secondary walls can be constructed immediately adjacent to existing walls, with a waterproof membrane, to provide adequate strength
- The effects of hydrostatic pressures on the walls and floors of below-grade areas
- Effective means to install watertight doors and windows, or mountable panels
- Protection where utilities enter the building
- Methods to address seepage, especially where long-duration flooding is anticipated
- Whether there is sufficient time for deployment of measures that require human intervention, given the availability of official warnings of predicted flood conditions

Application of waterproofing products or membranes directly to exterior walls may minimize infiltration of water; although there are concerns with durability and limitations on use (this measure is most effective for shallow, short-duration flooding). Some protection can be achieved using emergency measures that are not designed to be integral to the building (see Section 5.4.10).

### 5.4.6 Utility Installations

Some features of utility systems in existing schools that are prone to flooding may need to be modified to reduce damage. The effectiveness of such measures depends not only on the nature of the flooding, but the type of service and the degree of exposure. Table 5-3 in Section 5.6 lists some questions to help school facility planners and designers examine risk reduction measures.

Even if a school building is unlikely to sustain extensive structural damage from flooding, significant recovery costs and delayed re-occupancy may result if utility systems are damaged. The damage reduction measures described below can be applied, whether undertaken as part of large-scale retrofits of existing buildings or as separate projects.

**Relocate from below-grade areas:** The most vulnerable utility installations are those located below grade, and the most effective protection measure is to relocate them to higher floors or platforms that are at least 2 feet above the DFE. The complexity of rerouting pipes, conduits, ductwork, electrical service, lines, and connections will depend on building- and site-specific factors.

**Elevate components:** Whether located inside or outside of the building, some components of utility systems can be elevated in place on platforms, including electric transformers, communication switch boxes, water heaters, air-conditioning compressors, generators, furnaces, boilers, and heat pumps (see Figure 5-30).

**Anchor tanks and raise openings:** Existing tanks can be elevated or anchored, as described in Section 5.3.10. If anchored below the DFE, tank inlets, vents, fill pipes, and openings should be elevated above the DFE, or fitted with covers designed to prevent the inflow of floodwaters or outflow of the tank's contents.

**Protect components:** If utility components cannot be elevated, it may be feasible to construct watertight enclosures, or enclosures with watertight seals that require human intervention to install when flooding is predicted.



**Figure 5-30:**  
Utility component elevated above flood level

**Elevate control equipment:** Control panels, gas meters, and electrical panels can be elevated, even if the equipment they service cannot be protected.

**Separate electrical controls:** Where areas within an existing school are floodprone, separation of control panels and electrical feeders will facilitate shutdown before floodwaters arrive, and help protect workers during cleanup.

**Protect against electrical surges:** Current fluctuations and service interruptions are common in areas affected by flooding. Equipment and sensitive electrical components can be protected by installing surge protection and uninterruptible power supplies.

**Connections for portable generators:** Prewired portable generator connections allow for quick, failure-free connection and disconnection of the generators when needed for continued functionality.

### 5.4.7 Potable Water and Wastewater Systems

All plumbing fixtures connected to the potable water system may become weak points in the system if they allow floodwaters to contaminate the system. Relocating the fixtures and services that require plumbing to elevated floors and removing the fixtures that are below the DFE provides protection. Wellheads can be sealed with watertight casings or protected within sealed enclosures.

Wastewater system components become sources of contamination during floods. Rising floodwaters may force untreated sewage to backup through toilets. Specially designed devices that prevent backflow can be installed, or restrooms below the DFE can be provided with overhead piping that may require specially designed pumps to operate properly. Septic tanks can be sealed and anchored.

### 5.4.8 Other Damage Reduction Measures

A number of steps can be taken to make existing facilities in flood hazard areas more resistant to flood damage, which also facilitates rapid recovery, cleanup, and re-occupancy. Whether these measures can be used for a specific school depends, in part, on the characteristics of the flood hazard and the characteristics of the building itself. School facility planners and designers should consider the following measures:

- Rehabilitate and retrofit the building envelope with openings specifically designed to allow floodwaters to flow in and out to minimize hydrostatic pressure on walls (called wet floodproofing). Although it allows water to enter the building, this measure minimizes the likelihood of major structural damage. Walls that enclose interior spaces should also be retrofitted with openings. Note that this approach is not acceptable when full compliance is required, such as when an existing building is substantially improved or when a new addition is constructed.
- Replace interior walls that have cavities with flood-resistant construction or removable panels to facilitate cleanup and drying.
- Abandon the use of below-grade areas (basements) and fill them in to prevent structural damage.
- Permanently relocate high-value or sensitive functions that are often found on the ground floor of schools (e.g., offices, school records, libraries, and computer laboratories) to higher floors or elevated additions.
- Install backflow devices in sewer lines.



- Preplan actions to move damageable furniture and high-value contents from the lower floors to higher floors when a flood warning is issued.
- Replace wall, flooring, and finish materials with flood-resistant materials. Concrete floors with a sealed, polished, or terrazzo finish have few maintenance requirements, but tend to be slippery when wet.
- Use epoxy or other impervious paints on concrete and other permeable surfaces to minimize contamination.
- Install separate electric circuits and ground fault circuit interrupter protection in areas that will flood. Emergency measures should be provided so that electrical service can be shut down to avoid electrocution hazards.
- Relocate chemicals to storage areas not subject to flooding.

### 5.4.9 Drainage Improvements

Although drainage improvements will not alleviate flooding caused by rising waters that surround a building, such improvements will help to minimize water damage that can be caused by heavy rainfall. The flow of rainfall-runoff depends on the shape of the land around a school building and the adequacy of the drainage system. Rainfall-runoff will either follow pre-determined paths (above-ground gutters and swales and underground pipes) to intended outfalls, or it may overwhelm the drainage system and enter buildings. Significant damage can be attributed to undersized, poorly planned, or inadequately maintained drainage systems.

Local grading ordinances and stormwater management regulations often require drainage systems to handle the runoff that is associated with the 10-year frequency, 24-hour rainfall event. When heavier rainfall occurs or storms last longer, those systems are expected to overflow or back up. As a result, sometimes storm runoff can enter buildings, creating the same types of damage that are caused by general conditions of flooding.

Existing school campuses should be evaluated to determine whether the drainage system is adequate and whether significant damage could occur if the design is overwhelmed by heavier runoff volumes. In particular, close attention should be given to the large paved areas that are often close to school buildings. All of the rain that falls on impervious paved surfaces runs off. If paved areas are sloped towards buildings, the likelihood of damage to the building is increased. How the landscaping is maintained and whether drainage paths, gutters, and storm drain grates are kept clear of debris will also affect the efficiency of the drainage system.

### 5.4.10 Emergency Measures

Emergency response to flooding is outside the scope of this manual. However, feasible emergency measures may provide some protection. The following description pertains only to emergency measures that have been used to reduce flood damage to older buildings that are already located in flood hazard areas. They may not provide protection to occupants and they can experience a high frequency of failure depending on human factors related to deployment. These measures do not achieve compliance with building and life-safety codes for new construction.

Emergency barriers are measures of last resort, and should be used only when a credible flood warning with adequate lead time is available and dependable. These measures have varying degrees of success, depending on the available manpower, skill required for installation, long-term maintenance of materials and equipment, suitability for site-specific flood conditions, and amount of advanced warning. Complete evacuation of protected buildings is appropriate, because emergency measures do not provide adequate protection for the safety of occupants.

**Sandbag walls:** Unless emergency placement is planned well in advance or under the direction of trained personnel, most sandbag barriers are not constructed in accordance with proper practices, leading to leakage and failures. Because of the intensive work effort and length of time required for protection even from relatively shallow water, sandbag walls are not a reliable protection measure. To be effective, sandbags and sand should be stockpiled and checked regularly to ensure that sandbags have not deteriorated. Sandbags have some other drawbacks, including high disposal costs and their tendency to absorb pollutants from contaminated floodwaters, which necessitates disposal as hazardous waste.

**Water- or sand-filled barriers:** A number of vendors make barriers that can be assembled with relative ease and filled with water or sand (see Figure 5-31). The barriers must be specifically sized for the site. Training and annual drills are important so that personnel know how to place and deploy the barriers. Proper storage, including cleaning after deployment, is necessary to protect the materials over long periods of time.

**Panels for doors:** For shallow and short-duration flooding, panels of sturdy material can be made to fit doorways to minimize the entry of floodwaters, although failure is common. Effectiveness is increased significantly if a flexible gasket or sealant is provided, and the mounting hardware is designed to apply even pressure. Personnel must know where the materials are stored and be trained in their deployment. A number of vendors make special doors for permanent installation and drop-in panels or barriers that are designed to be watertight.



Figure 5-31:  
Gravel-filled containers  
form a barrier to protect  
the University of Iowa  
(2008)

## 5.5 Schools as Emergency Shelters and Safe Rooms

**E**mergency managers regularly identify schools to serve as short-term and/or long-term community shelters. They are attractive sites for community shelters because they are designed for many people, with kitchen facilities, restroom and shower facilities, and open space gymnasiums, cafeterias, and wide corridors for cots and general gathering.

New schools that are intended to be used as emergency shelters are appropriately designed as essential or critical facilities that warrant a higher degree of protection than other schools. If located in or adjacent to flood hazard areas, it is appropriate to provide protection for the building and utility systems to at least the 0.2-percent-annual-chance (500-year) flood level or, at a minimum, 2 to 3 feet above the DFE.

Additional guidance on hazard-resistant shelters can be found in FEMA 361, *Design and Construction Guidance for Community Safe Rooms* (2008).

Starting with the 2009 edition of the IBC, the design and construction of community shelters are governed by both the provisions of the code and ICC 500, *ICC/NSSA Standard on the Design and Construction of Storm Shelters* (2008). In addition to requirements related to resistance to high winds, ICC 500 specifies

that the minimum lowest floor elevation is the higher of four elevations: (1) the 0.2-percent-annual-chance flood (500-year) level; (2) the 1-percent-annual-chance flood level plus 2 feet (BFE + 2 feet); (3) 2 feet above the highest recorded flood elevation (if the area is not in a mapped SFHA); or (4) the maximum inundation elevation associated with a Category 5 hurricane event in an area subject to storm surge inundation.

The highest level of protection for sheltering is set forth in FEMA 361, *Design and Construction Guidance for Community Safe Rooms* (2008). The elevation criteria specified in FEMA 361 are equivalent to the criteria in the ICC 500 with one notable exception: to be designated a safe room, some special flood hazard areas must be avoided because the flood risk is too great. FEMA 361 guidance, which applies when the protection levels for safe rooms are desired, must be followed when Federal funding is being used to construct the safe room portion of a school. When designing an area of a school to provide the “near absolute” protection from tornadoes and hurricanes that are afforded by safe rooms, other criteria with respect to travel time to the safe room, the population to be protected, and the location of the safe room with respect to mapped flood hazard areas must all be considered. For additional information, please refer to the FEMA safe room policy MRR-2-09-1, *Hazard Mitigation Assistance for Safe Rooms* (2009c).

School districts and designers should also consider the following if schools are intended to be used as emergency shelters or safe rooms:

- Wastewater service must be functional during flooding conditions.
- Emergency power service must be provided.
- Dry-ground access is important even if flooding exceeds design levels.
- Mechanical and electrical equipment supporting the safe room or shelter must also be elevated as identified in FEMA 361 or ICC 500, respectively

## 5.6 Checklist for Vulnerability of Floodprone Sites and Schools

The Checklist for Building Vulnerability of Floodprone Schools (Table 5-3) is a tool that can be used to help assess site-specific flood hazards and building vulnerability. The checklist is useful during site selection, preliminary design of a new building, or when considering rehabilitation of an existing school. In addition to examining building design issues that affect vulnerability, the checklist also helps users to examine the functionality of the critical systems upon which most schools depend. The checklist is organized into separate sections, so that each section can be assigned to a subject expert for greater accuracy of the examination. The results should be integrated into a master vulnerability assessment to guide the design process and the choice of appropriate mitigation measures.

Table 5-3: Checklist for building vulnerability of floodprone schools

Vulnerability Sections	Guidance	Observations
<b>Site Conditions</b>		
<p><b>Is the site located near a body of water (with or without a mapped flood hazard area)?</b></p> <p><b>Is the site in a flood hazard area shown on the community’s map (FIRM or other adopted map)? If so, what is the flood zone?</b></p> <p><b>Is the site affected by a regulatory floodway?</b></p>	<p>All bodies of water are subject to flooding, but not all have been designated as a floodplain on FIRMs.</p> <p>Flood hazard maps usually are available for review in local planning and permit offices. Electronic versions of the FIRMs may be available online at <a href="http://www.fema.gov">www.fema.gov</a>. Paper maps may be ordered by calling (800) 358-9616.</p> <p>Development in floodways, where floodwaters typically are faster and deeper, must be supported by engineering analyses that demonstrate no rise in flood levels.</p>	
<p><b>Is the site located in a storm surge inundation zone (or tsunami inundation area)?</b></p>	<p>In coastal communities, even sites at some distance inland from the shoreline may be exposed to extreme storm surge flooding. Storm surge maps may be available at State or local emergency management offices.</p>	



Table 5-3: Checklist for building vulnerability of floodprone schools

Vulnerability Sections	Guidance	Observations
<b>Site Conditions</b>		
<p><b>What is the DFE (or does an analysis have to be done to determine the DFE)? What is the minimum protection level required by regulatory authorities?</b></p> <p><b>Does the FIS or other study have information about the 500-year flood hazard area?</b></p> <p><b>Has FEMA issued post-disaster advisory flood elevations and maps?</b></p> <p><b>What are the expected depths of flooding at the site (determined using flood elevations and ground elevations)?</b></p>	<p>Reference the FIS for flood profiles and data tables. Site-specific analyses should be performed by qualified engineers.</p> <p>Check with regulatory authorities to determine the required level of protection.</p> <p>If a major flood event has affected the community, FEMA may have issued new flood hazard information, especially if areas not shown on the FIRMs have been affected. Sometimes these maps are adopted and replace the FIRMs; sometimes the new data are advisory only.</p>	
<p><b>Has the site been affected by past flood events? What is the flood of record?</b></p>	<p>Records of actual flooding augment studies that predict flooding, especially if historic events resulted in deeper or more widespread flooding. Information may be available from local planning, emergency management, and public works agencies, or State agencies, the U.S. Army Corps of Engineers, or the Natural Resources Conservation Service.</p> <p>The flood of record is often a lower probability event (with higher flood elevations) than the 100-year flood.</p>	
<p><b>What is the expected velocity of floodwaters on the site?</b></p>	<p>Velocity is a factor in computing loads associated with hydrodynamic forces, including drag on building surfaces. Approximations of velocity may be interpolated from data in the FIS Floodway Data Table if the waterway was studied using detailed methods, application of approximation methods based on continuity, local observations and sources, or site-specific studies.</p>	
<p><b>Are waves expected to affect the site?</b></p>	<p>Waves can exert considerable dynamic forces on buildings and contribute to erosion and scour. Wind-driven waves occur in areas subject to coastal flooding and where unobstructed winds affect wide floodplains (large lakes and major rivers). Standing waves may occur in riverine floodplains where high velocities are present.</p>	
<p><b>Is there information on how quickly floodwaters may affect the site?</b></p> <p><b>What is the expected duration of flooding?</b></p>	<p>Warning time is a key factor in the safe and orderly evacuation of critical facilities. Certain protective measures may require adequate warning so that actions can be taken by skilled personnel.</p> <p>Duration has bearing on the stability of earthen fills, access to a site and emergency response, and durability of materials that come into contact with water. Records of actual flooding are the best indicator of duration as most floodplain analyses do not examine duration.</p>	

Table 5-3: Checklist for building vulnerability of floodprone schools

Vulnerability Sections	Guidance	Observations
Site Conditions		
<p><b>Is there a history of flood-related debris problems or erosion on the site?</b></p>	<p>Site design should account for deposition of debris and sediment, as well as the potential for erosion-related movement of the shoreline or waterway. Buildings exposed to debris impact or undermining by scour and erosion should be designed to account for these conditions.</p>	
<p><b>Is the site within an area predicted to flood if a levee or floodwall fails or is overtopped?</b></p> <p><b>Is the site in an area predicted to be inundated if an upstream dam were to fail?</b></p>	<p>Flood protection works may be distant from sites and not readily observable. Although a low probability event, failure or overtopping can cause unexpected and catastrophic damage because the protected lands are not regulated as flood hazard areas.</p> <p>The effects of an upstream dam failure are not shown on the FIRMs or most flood hazard maps prepared locally. Although dam failure generally is considered an unlikely event, the potential threat should be evaluated due to the catastrophic consequences. (Note: Owners of certain dams should have emergency action plans geared toward notification and evacuation of vulnerable populations and critical facilities.)</p>	
<p><b>Does the surrounding topography contribute to the flooding at the site? Is there a history of local surface drainage problems due to inadequate site drainage?</b></p>	<p>If areas with poor local drainage and frequent flooding cannot be avoided, filling, regrading, and installation of storm drainage facilities may be required.</p>	
<p><b>Given the nature of anticipated flooding and soils, is scour around and under the foundation likely?</b></p>	<p>Scour-prone sites should be avoided, in part due to likely long-term maintenance requirements. Flooding that is high velocity or accompanied by waves is more likely to cause scour, especially on fills, or where local soils are unconsolidated and subject to erosion.</p>	
<p><b>Has water from other sources entered the building (i.e., high groundwater, water main breaks, sewer backup, etc.)? Is there a history of water intrusion through floor slabs or well-floor connections? Are there underground utility systems or areaways that can contribute to basement flooding? Are there stormwater sewer manholes upslope of window areas or openings that allow local drainage to enter the basement/lower floor areas?</b></p>	<p>These questions pertain to existing facilities that may be impaired by water from sources other than the primary source of flooding. The entire building envelope, including below-grade areas, should be examined to identify potential water damage.</p>	

Table 5-3: Checklist for building vulnerability of floodprone schools

Vulnerability Sections	Guidance	Observations
<b>Site Conditions</b>		
<p><b>Is at least one access road to the site/building passable during flood events?</b></p> <p><b>Are at-grade parking lots located in floodprone areas?</b></p> <p><b>Are below-grade parking areas susceptible to flooding?</b></p>	<p>Access is increasingly important as the duration of flooding increases. For the safety of occupants, most critical facilities should not be occupied during flood events.</p> <p>Areas where vehicles could be affected should have signage to warn users, including bus drivers, of the risk. Emergency response plans should include notification of car owners.</p>	
<b>Architectural</b>		
<p><b>Are any critical building functions occupying space that is below the elevation of the 500-year flood or the DFE?</b></p> <p><b>Can critical functions be relocated to upper levels that are above predicted flood elevations?</b></p> <p><b>If critical functions cannot be relocated, is floodproofing feasible?</b></p> <p><b>If critical functions must continue during a flood event, have power, supplies, and access issues been addressed?</b></p>	<p>New critical facilities built in flood hazard areas should not have any functions occupying floodprone spaces (other than parking, building access, and limited storage).</p> <p>Existing facilities in floodplains should be examined carefully to identify the best options for protecting functionality and the structure itself.</p>	
<p><b>Have critical contents (files, computers, servers, equipment, research, and data) been located on levels of the facility above the flood elevations?</b></p> <p><b>Are critical records maintained offsite?</b></p>	<p>For existing facilities that are already located in flood hazard areas, the nature of the facility may require continued use of floodprone space. However, the potential for flooding should be recognized and steps taken to minimize loss of expensive equipment and irreplaceable data. If critical contents cannot be permanently located on higher floors, a flood response plan should take into account the time and attention needed to move such contents safely.</p>	
<b>Structural Systems</b>		
<p><b>What is the construction type and the foundation type and what is the load bearing capacity?</b></p> <p><b>Has the foundation been designed to resist hydrostatic and hydrodynamic flood loads?</b></p>	<p>If siting in a floodplain is unavoidable, new facilities are to be designed to account for all loads and load combinations, including flood loads.</p>	

Table 5-3: Checklist for building vulnerability of floodprone schools

Vulnerability Sections	Guidance	Observations
<b>Structural Systems</b>		
<p><b>If the building has below-grade areas (basements), are the lower floor slabs subject to cracking and uplift?</b></p>	<p>Below-grade spaces and their contents are most vulnerable to flooding and local drainage problems. Rapid pump out of below-grade spaces can unbalance forces if the surrounding soil is saturated, leading to structural failure. If below-grade spaces are intended to be dry floodproofed, the design must account for buoyant forces.</p> <p>Building spaces below the design flood level can be dry floodproofed, although it must be recognized that higher flood levels will overtop the protection measures and may result in severe damage. Dry floodproofing creates large unbalanced forces that can jeopardize walls and foundations that are not designed to resist the hydrostatic and hydrodynamic loads.</p>	
<p><b>Are any portions of the building below the DFE?</b></p> <p><b>Has the building been damaged in previous floods?</b></p>	<p>For existing buildings, it is important to determine which portions are vulnerable in order to evaluate floodproofing options. If flood depths are expected to exceed 2 or 3 feet, dry floodproofing may not be feasible. Alternatives include modifying the use of floodprone areas.</p>	
<p><b>If the building is elevated on a crawlspace or on an open foundation, are there any enclosed areas?</b></p>	<p>New buildings may have enclosures below the flood elevation, provided the use of the enclosures is limited (crawlspace, parking, building access, and limited storage). In addition, the enclosures must have flood openings to automatically allow for inflow and outflow of floodwaters to minimize differential hydrostatic pressure.</p> <p>Existing buildings that are elevated and have enclosures below the flood elevation can be retrofit with flood openings.</p>	
<p><b>For an existing building with high-value uses below the flood elevation, is the building suitable for elevation-in-place, or can it be relocated to higher ground?</b></p>	<p>Elevating a building provides better protection than dry floodproofing. Depending on the type and soundness of the foundation, even large buildings can be elevated on a new foundation or moved to a site outside of the floodplain.</p>	
<b>Building Envelope</b>		
<p><b>Are there existing floodproofing measures in place below the expected flood elevation? What is the nature of these measures and what condition are they in? Is there an annual inspection and maintenance plan?</b></p> <p><b>Is there an “action plan” to implement floodproofing measures when flooding is predicted? Do the building operators/occupants know what to do when a flood warning is issued?</b></p>	<p>Floodproofing measures are only as good as the design and their condition, especially if many years have passed since initial installation. Floodproofing measures that require human intervention are entirely dependent on the adequacy of advance warning, and the availability and ability of personnel to properly install the measures.</p>	

Table 5-3: Checklist for building vulnerability of floodprone schools

Vulnerability Sections	Guidance	Observations
<b>Building Envelope</b>		
<p><b>For existing buildings, what types of openings penetrate the building envelope below the 500-year flood elevation or the DFE (doors, windows, cracks, vent openings, plumbing fixtures, floor drains, etc.)?</b></p>	<p>For dry floodproofing to be effective, every opening must be identified and measures taken to permanently seal or to prepare special barriers to resist infiltration. Sewage backflow can enter through unprotected plumbing fixtures.</p>	
<p><b>Are flood-resistant materials used for structural and nonstructural components and finishes below the 500-year elevation or the DFE?</b></p>	<p>Flood-resistant materials are capable of withstanding direct and prolonged contact with floodwaters without sustaining damage that requires more than cosmetic repair. Contact is considered to be prolonged if it is 72 hours or longer in freshwater flooding areas, or 12 hours or longer in areas subject to coastal flooding.</p>	
<b>Utility Systems</b>		
<p><b>Is the potable water supply for the facility protected from flooding? If served by a well, is the wellhead protected?</b></p>	<p>Operators of critical facilities that depend on fresh water for continued functionality should learn about the vulnerability of the local water supply system, and the system's plans for recovery of service in the event of a flood.</p>	
<p><b>Is the wastewater service for the building protected from flooding?</b></p> <p><b>Are any manholes below the DFE? Is infiltration of floodwaters into sewer lines a problem? If the site is served by an onsite system that is located in a floodprone area, have backflow valves been installed?</b></p>	<p>Most waste lines exit buildings at the lowest elevation. Even buildings that are outside of the floodplain can be affected by sewage backups during floods.</p>	
<p><b>Are there any aboveground or underground tanks on the site in flood hazard areas? Are they installed and anchored to resist flotation during the design flood? Are tank openings and vents elevated above the 500-year elevation or the DFE, or otherwise protected to prevent entry of floodwater or exit of product during a flood event?</b></p>	<p>Dislodged tanks become floating debris that pose special hazards during recovery. Lost product causes environmental damage. Functionality may be impaired if tanks for heating fuel, propane, or fuel for emergency generators are lost or damaged.</p>	
<b>Mechanical Systems</b>		
<p><b>Are air handlers, HVAC systems, ductwork, and other mechanical equipment and systems located above the 500-year elevation or the DFE? Are the vents and inlets located above flood level, or sealed to prevent entry of floodwater?</b></p>	<p>In existing buildings, utility equipment that is critical for functionality should be relocated to higher floors or into elevated additions.</p>	
<b>Plumbing and Gas Systems</b>		
<p><b>Are plumbing fixtures and gas-fired equipment (meters, pilot-light devices/ burners, etc.) located above the 500-year elevation or the DFE?</b></p>	<p>In existing buildings, utility equipment that is critical for functionality should be relocated to higher floors or into elevated additions.</p>	



Table 5-3: Checklist for building vulnerability of floodprone schools

Vulnerability Sections	Guidance	Observations
<b>Plumbing and Gas Systems</b>		
<b>Is plumbing and gas piping that extends below flood levels installed to minimize damage?</b>	Piping that is exposed could be impacted by debris.	
<b>Electrical Systems</b>		
<p><b>Are electrical systems, including backup power generators, panels, and primary service equipment, located above the 500-year elevation or the DFE?</b></p> <p><b>Are pieces of electrical stand-by equipment and generators equipped with circuits to turn off power?</b></p> <p><b>Are the switches and wiring required for safety (minimal lighting, door openers) located below the flood level designed for use in damp locations?</b></p>	In existing buildings, utility equipment that is critical for functionality should be relocated to higher floors or into elevated additions.	
<b>Fire Alarm Systems</b>		
<b>Is the fire alarm system located above the 500-year elevation or the DFE?</b>	In existing buildings, utility equipment that is critical for functionality should be relocated to higher floors or into elevated additions.	
<b>Communications and IT Systems</b>		
<b>Are the communication/IT systems located above the 500-year elevation or the DFE?</b>		

## 5.7 References and Sources of Additional Information

American Society of Civil Engineers (ASCE), 2005a. *Flood Resistant Design and Construction*, ASCE/SEI 24-05, Structural Engineering Institute, Reston, VA.

ASCE, 2005b. *Minimum Design Loads for Buildings and Other Structures*, ASCE 7-05, Structural Engineering Institute, Reston, VA.

ASCE, 2010. *Minimum Design Loads for Buildings and Other Structures*, 2010 Edition, ASCE 7-10, Structural Engineering Institute, Reston, VA.

Association of State Floodplain Managers, Inc. (ASFPM), 2004. *Floodplain Management 2003*. State and Local Programs, Madison, WI.

Executive Order 11988. *Floodplain Management*, May 24, 1977, 42 F.R. 26951.

Federal Emergency Management Agency (FEMA), 1986. *Floodproofing Non-Residential Structures*, FEMA 102, Washington, DC, May 1986.

FEMA, 1991. *Answers to Questions about Substantially Damaged Buildings*, FEMA 213, Washington, DC, May 1991.

FEMA, 1999. *Protecting Building Utilities From Flood Damage. Principles and Practices for the Design and Construction of Flood Resistant Building Utility Systems*, FEMA 348, Washington, DC, November 1999.

FEMA, 2000. *Coastal Construction Manual*, FEMA 55CD (3rd Edition), Washington, DC.

FEMA, 2001. *Engineering Principles and Practices for Retrofitting Flood-prone Residential Buildings*, FEMA 259, Washington, DC, June 2001.

FEMA, 2008. *Design and Construction Guidance for Community Shelters*, FEMA 361, Washington, DC, November 2008.

FEMA, 2009a. *Answers to Questions about the National Flood Insurance Program*, FEMA F-084, September 2009.

FEMA, 2009b. *Protecting Manufactured Homes from Floods and Other Hazards. A Multi-Hazard Foundation and Installation Guide*, FEMA P-85, Washington, DC.

FEMA 2009c. Hazard Mitigation Assistance for Safe Rooms, FEMA Mitigation Interim Policy, MRR-2-09-1, April 30, 2009

FEMA, 2010. *Substantial Improvement/Substantial Damage Desk Reference*, FEMA P-758, Washington, DC.

FEMA and American Red Cross (ARC), 1992. *Repairing Your Flooded Home*, FEMA 234/ARC 4477. Washington, DC. (available at <http://www.redcross.org>, local Red Cross chapters, and FEMA).

FEMA publications may be obtained at no cost by calling (800)480-2520, faxing a request to (240) 699-2520, or downloaded from the library/publications sections online at <http://www.fema.gov>.

**Federal Emergency Management Agency, NFIP Technical Bulletins.**

- *User's Guide to Technical Bulletins*, FIA-TB-0, March 2009.
- *Openings in Foundation Walls and Walls of Enclosures*, FEMA-TB-1, August 2008.
- *Flood Damage-Resistant Materials Requirements*, FEMA-TB-2, August 2008.
- *Non-Residential Floodproofing—Requirements and Certification*, FIA-TB-3, April 1993.
- *Elevator Installation*, FIA-TB-4, April 1993.
- *Free-of-Obstruction Requirements*, FEMA-TB-5, August 2008.
- *Below-Grade Parking Requirements*, FIA-TB-6, April 1993.
- *Wet Floodproofing Requirements*, FIA-TB-7, December 1993.
- *Corrosion Protection for Metal Connectors in Coastal Areas*, FIA-TB-8, 1996.
- *Design and Construction Guidance for Breakaway Walls Below Elevated Coastal Buildings*, FEMA-TB-9, August 2008.
- *Ensuring That Structures Built on Fill In or Near Special Flood Hazard Areas Are Reasonably Safe From Flooding*, FIA-TB-10, 2001.
- *Crawlspace Construction for Buildings Located in Special Flood Hazard Areas*, FIA-TB-11, 2001.

International Code Council (ICC), 2008. *ICC/NSSA Standard on the Design and Construction of Storm Shelters*, ICC 500, August 2008, Country Club Hills, IL.

ICC and FEMA, 2008, *Reducing Flood Losses Through the International Codes, Meeting the Requirements of the National Flood Insurance Program (2006 I-Codes)*, Country Club Hills, IL.

ICC, 2009. *International Building Code 2009*, Country Club Hills, IL.

National Academy of Sciences, 1977. *Methodology for Calculating Wave Action Effects Associated with Storm Surges*, Washington, DC.

National Fire Protection Association (NFPA), 2009. *Building Construction and Safety Code*, NFPA 5000, Quincy, MA.

U.S. Army Corps of Engineers (USACE), 1993. *Flood Proofing – How To Evaluate Your Options*, National Flood Proofing Committee, Washington, DC, July 1993.

USACE, 1995. *Flood Proofing Regulations*, EP 1165-2-314, Washington, DC.

USACE, 1996. *Flood Proofing Techniques, Programs, and References*, Washington, DC.

USACE, 1998. *Flood Proofing Performance – Successes & Failures*, Washington, DC.

U.S. Environmental Protection Agency (EPA), 2001, *Mold Remediation in Schools and Commercial Buildings*, EPA 402-K-01-001, Washington, DC.

### **Organizations and Agencies**

Federal Emergency Management Agency: 10 regional offices ([www.fema.gov](http://www.fema.gov)) can be contacted for advice and guidance on NFIP mapping and regulations.

NFIP State Coordinating offices help local governments to meet their floodplain management obligations and may provide technical advice to others; the offices are listed by the Association of State Floodplain Managers, Inc., ([www.floods.org/stcoor.htm](http://www.floods.org/stcoor.htm)).

State departments of education or agencies that coordinate State funding and guidelines for schools may have State-specific requirements.

U.S. Army Corps of Engineers. District offices offer Flood Plain Management Services ([www.nap.usace.army.mil/cenap-op/regulatory/districts.html](http://www.nap.usace.army.mil/cenap-op/regulatory/districts.html)).

## **5.8 Glossary of Flood Protection Terms**

**Advisory Base Flood Elevation.** Flood elevation that is determined by a reassessment of base flood elevations conducted after significant flood events.

**Base flood.** The flood having a 1-percent chance of being equaled or exceeded in any given year, commonly referred to as the “100-year flood.” The base flood is the national standard used by the NFIP and all Federal agencies for the purpose of regulating development.

**Base flood elevation (BFE).** The height of the base (1-percent or 100-year) flood in relation to a specified datum, usually the National Geodetic Vertical Datum of 1929 or the North American Vertical Datum of 1988.

**Coastal High Hazard Area.** An area of special flood hazard extending from offshore to the inland limit of a primary frontal dune along an open coast and any other area subject to high velocity wave action from storms. Coastal high hazard areas also are referred to as “V Zones” and are designated on Flood Insurance Rate Maps (FIRMs) as zones VE or V1-30.

**Design flood.** The greater of the following two flood events. (1) the base flood, affecting those areas identified as special flood hazard areas on a community’s FIRM; or (2) the flood corresponding to the area designated as a flood hazard area on a community’s flood hazard map or otherwise legally designated.

**Design flood elevation (DFE).** The elevation of the design flood, including wave height, relative to the datum specified on a community’s flood hazard map.

**Dry floodproofing.** Any combination of structural and nonstructural additions, changes, or adjustments to structures, or combinations thereof that eliminate or reduce the potential for flood damage by resisting flood loads, sealing walls, and closing openings to keep water from entering a building.

**Federal Emergency Management Agency (FEMA).** The Federal agency that, among other functions, administers the National Flood Insurance Program (NFIP).

**Flood Insurance Rate Map (FIRM).** The official map of a community on which FEMA has delineated both special flood hazard areas (SFHA) and flood zones. Some FIRMs include base flood elevations, 500-year floodplain boundaries, and regulatory floodway boundaries.

**Flood Insurance Study (FIS).** An engineering study performed by FEMA to identify flood hazard areas, flood insurance risk zones, and other flood data in a community; used in the development of the FIRM.

**Flood profile.** A graph of computed flood elevations at points located along a riverine waterway. Flood profiles typically are available for waterways that have BFEs shown on FIRMs, and are found in FISs.

**Flood zone.** A designation for areas that are shown on Flood Insurance Rate Maps.

**Floodplain.** Any land area, including a watercourse and the land adjacent to it, that is susceptible to being inundated by water from any source.



**Floodplain management regulations.** Zoning ordinances, subdivision regulations, building codes, health regulations, or special-purpose ordinances that set flood-resistant standards for construction and development.

**Floodway.** The channel of a river or other watercourse and the adjacent land areas that must be reserved in order to discharge the base flood without cumulatively increasing the water surface elevation by more than a designated height.

**Freeboard.** A factor of safety, usually expressed in feet above a flood level, for purposes of floodplain management. Freeboard also compensates for unknown factors that could contribute to flood heights greater than the height calculated for a selected frequency flood and floodway conditions, such as wave action, blockage of bridge openings, and the effects of upland urbanization. A freeboard of from 1 to 3 feet is often applied to critical facilities.

**Human intervention.** Actions that must be taken by one or more persons in order for a building to be floodproofed prior to the onset of flooding.

**Hydrodynamic load.** The load imposed by water flowing against and around an object or structure, including the impact of debris and waves.

**Hydrostatic load.** The load (pressure) imposed on an object or structure by a standing or slowly moving mass of water; the deeper the water, the greater the hydrostatic load or pressure.

**Limit of Moderate Wave Action.** The inland limit of the area affected by waves greater than 1.5 feet.

**Lowest floor.** The lowest floor of the lowest enclosed area (including a basement) of a building. An unfinished or flood-resistant enclosure, usable solely for parking of vehicles, building access, or storage, in an area other than a basement, is not considered a building's lowest floor, provided that the enclosure is compliant with flood-resistant requirements.

**National Flood Insurance Program (NFIP).** The Federal program, administered by FEMA, that identifies flood-prone areas nationwide and makes flood insurance available for properties in communities that participate in the program.

**Scour.** Removal of soil or fill material from the channel cross-section or land surface by the flow of floodwaters.

**Sheetflow.** Rainfall-runoff that flows over relatively flat land without concentrating into streams or channels.

**Special flood hazard area.** An area delineated on a FIRM as being subject to inundation by the base flood and designated as Zone A, AE, A1–A30, AR, AO, AH, A99, V, VE, or V1–V30.

**Stillwater elevation.** The elevation that the surface of coastal floodwaters would assume in the absence of waves, referenced to a datum.

**Substantial damage.** Damage of any origin sustained by a structure, whereby the cost of restoring the structure to its pre-damage condition equals or exceeds 50 percent of the market value of the structure before the damage occurred (or smaller percentage if established by the authority having jurisdiction). Structures that are determined to be substantially damaged are considered to be substantial improvements, regardless of the actual repair work performed.

**Substantial improvement.** Any reconstruction, rehabilitation, addition, or other improvement of a structure, the cost of which equals or exceeds 50 percent of the market value of the structure (or smaller percentage if established by the authority having jurisdiction) before the start of the improvement.

**Wave runup.** Rush of wave water running up a slope or structure.

**Wet floodproofing.** Permanent or contingent measures applied to a building and/or its contents to minimize flood damage by modifying interior finishes, removing damageable items from lower areas, and allowing water into the building.





## Design Guide

for Improving School Safety  
in Earthquakes, Floods, and High Winds

# 6 Making Schools Safe From High Winds

## 6.1 General Design Considerations

**W**ind with sufficient speed to cause damage to weak schools can occur anywhere in the United States and its territories.<sup>1</sup> Even a well-designed, constructed, and maintained school may be damaged by a wind event much stronger than one the building was designed for. However, except for tornado damage, this scenario is a rare occurrence. Rather, most damage occurs because various building elements have limited wind resistance due to inadequate design, poor installation, or material deterioration. Although the magnitude and frequency of strong windstorms vary by locale, all schools should be designed, constructed, and maintained to minimize wind damage (other than that associated with tornadoes—see Section 6.5).

<sup>1</sup> The U.S. territories include American Samoa, Guam, Northern Mariana Islands, Puerto Rico, and the U.S. Virgin Islands. ASCE 7 provides basic wind speed criteria for all but Northern Mariana Islands.

This chapter discusses structural, building envelope, and nonstructural building systems, and illustrates various types of wind-induced damage that affect them. Numerous examples of best practices pertaining to new and existing schools are presented as recommended design guidelines. Incorporating those practices applicable to specific projects will result in greater wind-resistance reliability and will, therefore, decrease expenditures for repair of wind-damaged facilities, provide enhanced protection for occupants, and avoid school disruption (see Figure 6-1).

The recommendations presented in this design guide are based on field observation research conducted on a large number of schools that were struck by hurricanes.<sup>3</sup> The recommendations are also based on numerous investigations of other types of critical and non-critical facilities exposed to hurricanes, tornadoes, and straight-line winds, and on literature review. Some of the schools were exposed to extremely high wind speeds, while others experienced moderate speeds.

**Figure 6-1:**  
Large portions of the roof coverings blew off of this school. Estimated wind speed: Approximately 125 to 130 miles per hour (mph).<sup>2</sup> Hurricane Katrina (Louisiana, 2005)



2 Estimated speeds given in this chapter are for a 3-second gust at a 33-foot elevation for Exposure C (as defined in ASCE 7). In most instances, the buildings for which estimated speeds are given are located in Exposure B. Hence, in most cases, the actual wind speed was less than the wind speed given for Exposure C conditions. For example, a 130-mph Exposure C speed is equivalent to 110 mph in Exposure B.

3 The research on the schools was conducted by a team from Texas Tech University (Hurricane Hugo, Charleston, SC, 1989), a team under the auspices of the Wind Engineering Research Council—now known as the American Association for Wind Engineering (Hurricane Andrew, South Florida, 1992), and teams deployed by FEMA (Hurricane Marilyn, U.S. Virgin Islands, 1995; Typhoon Paka, Guam, 1997; Hurricane Charley, Port Charlotte, FL, 2004; Hurricane Frances, east coast of Florida, 2004; Hurricane Ivan, Pensacola, FL, 2004; Hurricane Katrina, Louisiana and Mississippi, 2005; and Hurricane Ike, Texas, 2008).

### 6.1.1 Nature of High Winds

A variety of windstorm types occur in different areas of the United States. The characteristics of the types of storms that can affect the site should be considered by the design team. The primary storm types are straight-line winds, down-slope winds, thunderstorms, downbursts, northeasters (nor'easters), hurricanes, and tornadoes. For information on these storm types, refer to Section 3.1.1 in FEMA 543.<sup>4</sup>

Of all the storm types, hurricanes have the greatest potential for devastating a large geographical area and, hence, affect the greatest number of people. See Figure 6-2 for hurricane-prone regions.

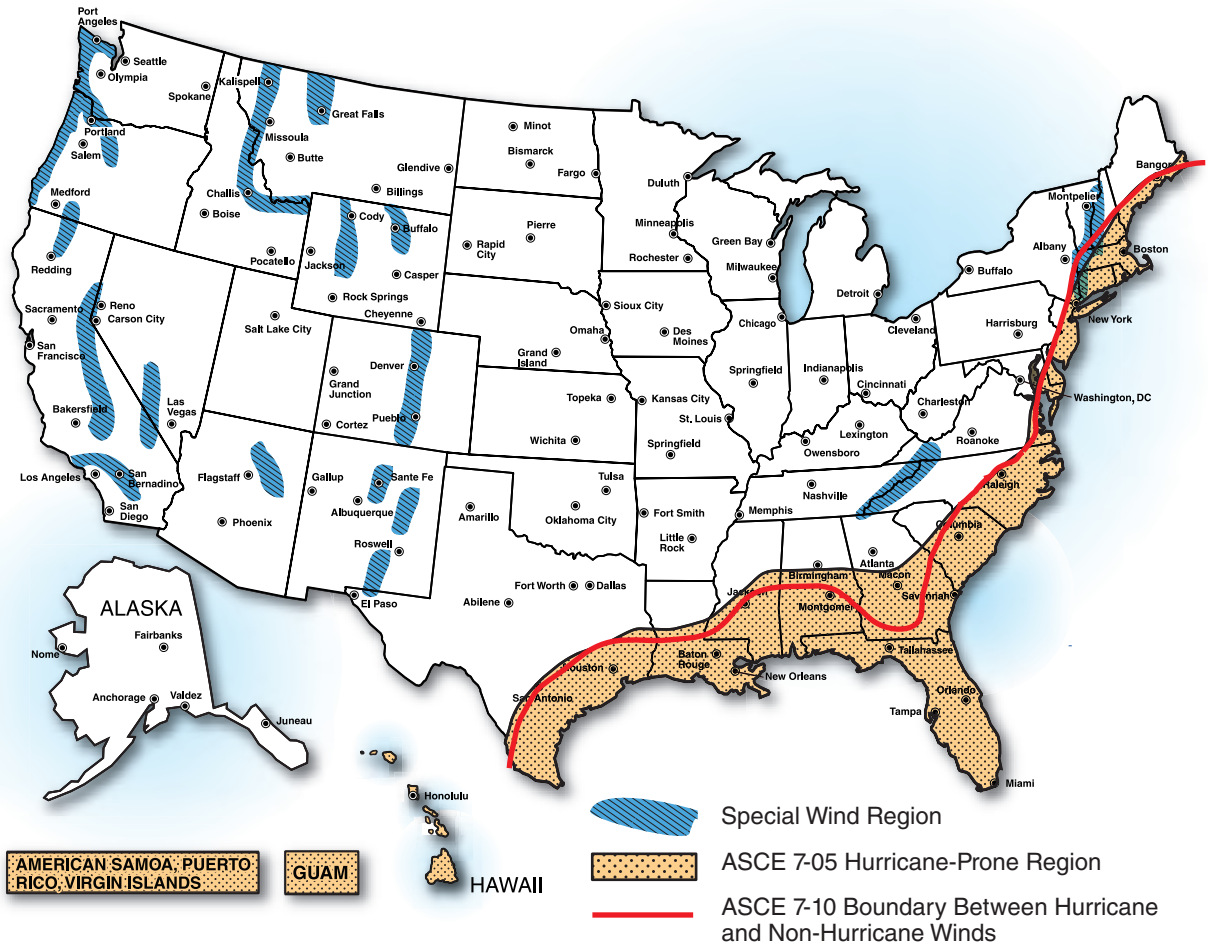

Figure 6-2: Hurricane-prone regions and special wind regions

SOURCE: ADAPTED FROM ASCE 7-10

4 Available at the FEMA Web site. See [www.fema.gov/library/viewRecord.do?id=2441](http://www.fema.gov/library/viewRecord.do?id=2441)



### 6.1.2 Probability of Occurrence

When designing a school, design professionals should consider the following types of winds:

**Routine winds:** In many locations, winds with low to moderate speeds occur daily. Damage is not expected to occur during these events.

**Stronger winds:** At a given site, stronger winds (i.e., winds with a speed in the range of 70- to 80-mph peak gust, measured at 33 feet in Exposure C—refer to Section 6.1.3) may occur from several times a year to only once a year or even less frequently. This is the threshold at which damage normally begins to occur to building elements that have limited wind resistance due to problems associated with inadequate design, insufficient strength, poor installation, or material deterioration.

**Design level winds:** At a given site, the probability of design level winds occurring in a given year is very low. Schools exposed to design level events and events that are somewhat in excess of design level should experience little, if any, damage. Actual storm history, however, has shown that design level storms frequently cause extensive building envelope damage. Structural damage also occurs, but less frequently. Damage incurred in design level events is typically associated with inadequate design, poor installation, or material deterioration. The exceptions are wind-driven water infiltration and wind-borne debris (missiles) damage. Water infiltration is discussed in Sections 6.3.3.1, 6.3.3.2, and 6.3.3.4.

**Tornadoes:** Although more than 1,200 tornadoes typically occur each year in the United States, the probability of a tornado occurring at any given location is quite small. The probability of occurrence is a function of location. As described in Section 6.5, only a few areas of the country

frequently experience tornadoes, and tornadoes are very rare in the west. Figure 6-3 shows the top 20 tornado-prone States in the United States. The Oklahoma City area is the most active location, with 123 recorded tornadoes between 1890 and 2008 (Edwards, 2009). Well-designed, constructed, and maintained schools should experience little if any damage from weak tornadoes, except for window breakage. However, weak tornadoes often cause building envelope damage because of wind-resistance deficiencies. Most schools experience significant damage if they are in the path of a strong or violent tornado because they typically are not designed for this type of storm.

Missile damage is very common during hurricanes and tornadoes. Missiles can puncture roof coverings, many types of exterior walls, and glazing. The IBC does not address missile-induced damage, except for glazing in wind-borne debris regions. (Wind-borne debris regions are limited to portions of hurricane-prone regions.) In hurricane-prone regions, significant missile-induced building damage should be expected, even during design level hurricane events, unless special enhancements are incorporated into the building's design (discussed in Section 6.3).

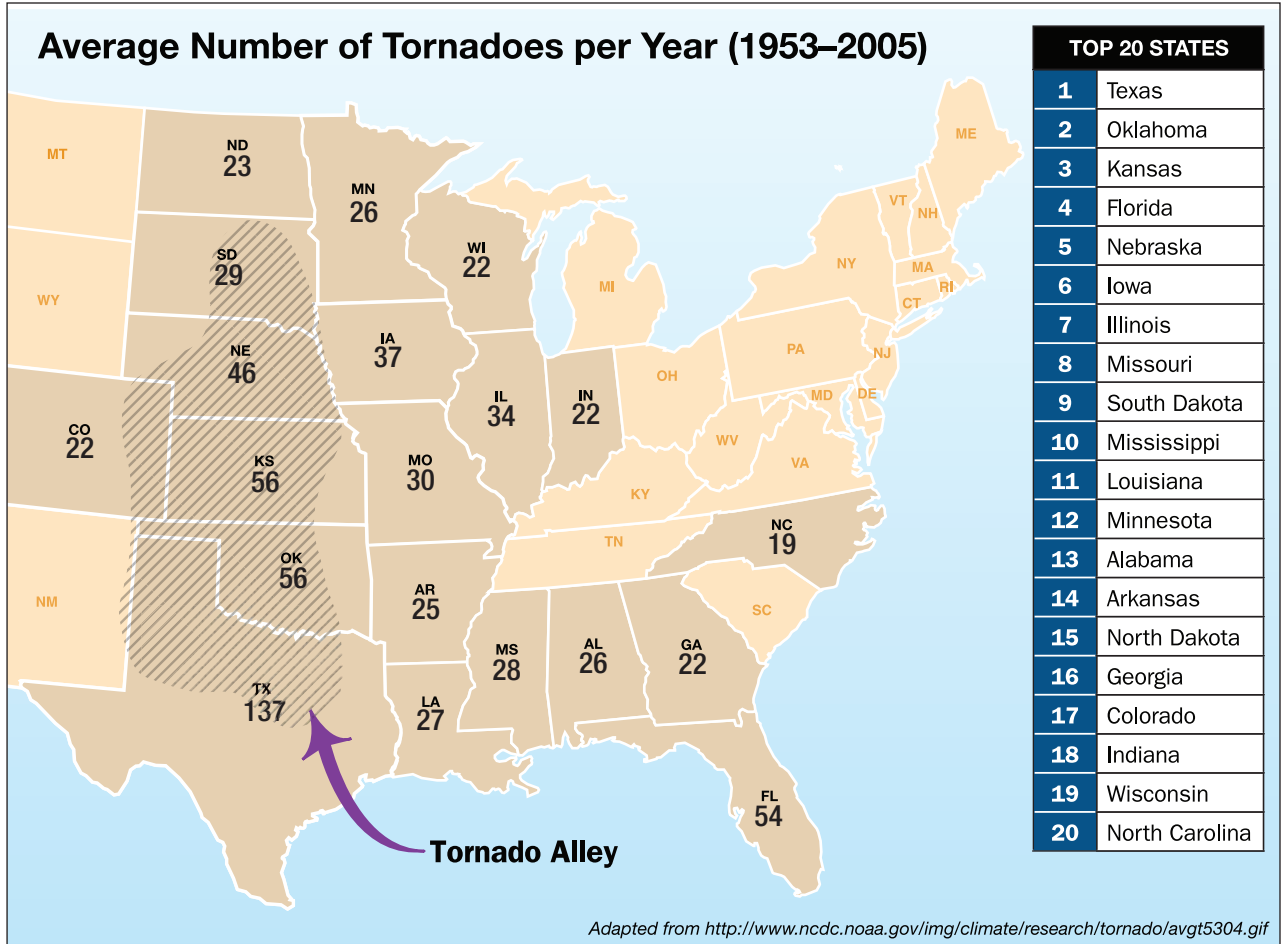

Figure 6-3: Average number of tornadoes per year (1953–2005)

In the classroom wing shown in Figure 6-4, all of the exterior windows were broken, and virtually all of the cementitious wood-fiber deck panels were blown away during a tornado. Much of the metal decking over the band and chorus area also blew off. The gymnasium collapsed, as did a portion of the multi-purpose room. The school was not in session at the time the tornado struck. See Section 6.5 for recommendations pertaining to tornadoes.

**Figure 6-4:**  
This high school was damaged by a strong tornado (Plainfield, IL 1990)



### 6.1.3 Wind/Building Interactions

When wind interacts with a building, both positive and negative (i.e., suction) pressures occur simultaneously. Schools must have sufficient strength to resist the applied loads from these pressures to prevent wind-induced building failure. Loads exerted on the building envelope are

transferred to the structural system, where in turn they must be transferred through the foundation into the ground. The magnitude of the pressures is a function of the following primary factors: exposure, basic wind speed, topography, building height, internal pressure, and building shape. General information on exposure and basic wind speed is presented below. For general information on topography, building height, and internal pressure, refer to Section 3.1.3 in FEMA 543. A description of key issues follows.

ASCE 7 specifies procedures for calculating wind pressures and forces based on the primary factors listed above. The IBC refers to ASCE 7 for wind load determination.

In the 2005 and earlier editions of ASCE 7, Exposure C included areas adjacent to water surfaces in hurricane-prone regions because earlier research indicated that wave conditions generated by hurricanes resulted in roughness that approximated Exposure C conditions. However, subsequent research showed that the surface roughness over the ocean during a hurricane is consistent with that of Exposure D. Consequently, the 2010 edition of ASCE 7 requires use of Exposure D along the hurricane coastline.

**Exposure:** The characteristics of the terrain (i.e., ground roughness and surface irregularities in the vicinity of a building) influence the wind loading. ASCE 7 defines three exposure categories, Exposures B, C, and D. Exposure B is the roughest terrain category and Exposure D is the

smoothest. Exposure B includes urban, suburban, and wooded areas. Exposure C includes flat open terrain with scattered obstructions and grasslands. Exposure D includes areas adjacent to water surfaces, mud flats, salt flats, and unbroken ice.

The smoother the terrain, the greater the wind load; therefore, schools (with the same basic wind speed) located in Exposure D would receive higher wind loads than those located in Exposure C.

**Wind speed:** ASCE 7 specifies the basic (design) wind speed for determining design wind loads. The basic wind speed is measured at 33 feet above grade in Exposure C (flat open terrain). If the building is located in Exposure B or D, rather than C, an adjustment for the actual exposure is made in the ASCE 7 calculation procedure.

Since the 1995 edition of ASCE 7, the basic wind speed measurement has been a 3-second peak gust speed. Prior to that time, the basic wind speed was a fastest-mile speed (i.e., the speed averaged over the time required for a mile-long column of air to pass a fixed point). Because the measuring time for peak gust versus fastest-mile is different, peak gust speeds are greater than fastest-mile speeds.

In the 2005 and earlier editions of ASCE 7, one map was used to determine the basic wind speed. However, in the 2010 edition of ASCE 7, three maps based on building risk provide the basic wind speed. One map is for Risk Category I buildings, another for Risk Category II buildings, and another for Risk Category III and IV buildings. All three are strength design wind speed maps. Hence, a load factor of 1.0 is used, rather than 1.6 as used in the 2005 edition. To account for the degree of hazard to human life and damage to property, the 2005 and earlier editions of ASCE 7 used an importance factor in the load calculation equation. In the 2010 edition, the importance factor was eliminated because the degree of hazard to human life and property damage is accounted for by the wind speeds in the appropriate map. Figure 6-5 shows the map for Risk Category III and IV, which as discussed in Section 6.3.1.2 are the Categories that this manual recommends for all schools.

For additional exposure information, see the Commentary of ASCE 7, which includes several aerial photographs that illustrate the different terrain conditions associated with Exposures B, C, and D.

Although the ASCE 7-10 maps provide strength design wind speeds, for the design of hurricane and tornado safe rooms/shelters, the design wind speeds given in FEMA 361 and ICC 500 are recommended (see Section 6.5). The FEMA 361 and ICC 500 speeds are based on a much greater mean recurrence interval than the ASCE 7 speeds.

Because the ASCE 7-10 maps are strength design wind speeds, the speeds are substantially greater than the speeds given in the 2005 and earlier editions. However, because of the load factor change, pressures calculated in accordance with the 2010 edition should be similar to those calculated in accordance with the 2005 edition.

Refer to Section 5.1.6.4 for a discussion of Risk Category III and IV.

Applied Technology Council wind speed Web site: A site-specific basic wind speed can be obtained at the following Web site by entering the site location. The Web site provides speeds based on ASCE 7-93, 7-05, and 7-10. <http://windspeed.atcouncil.org>



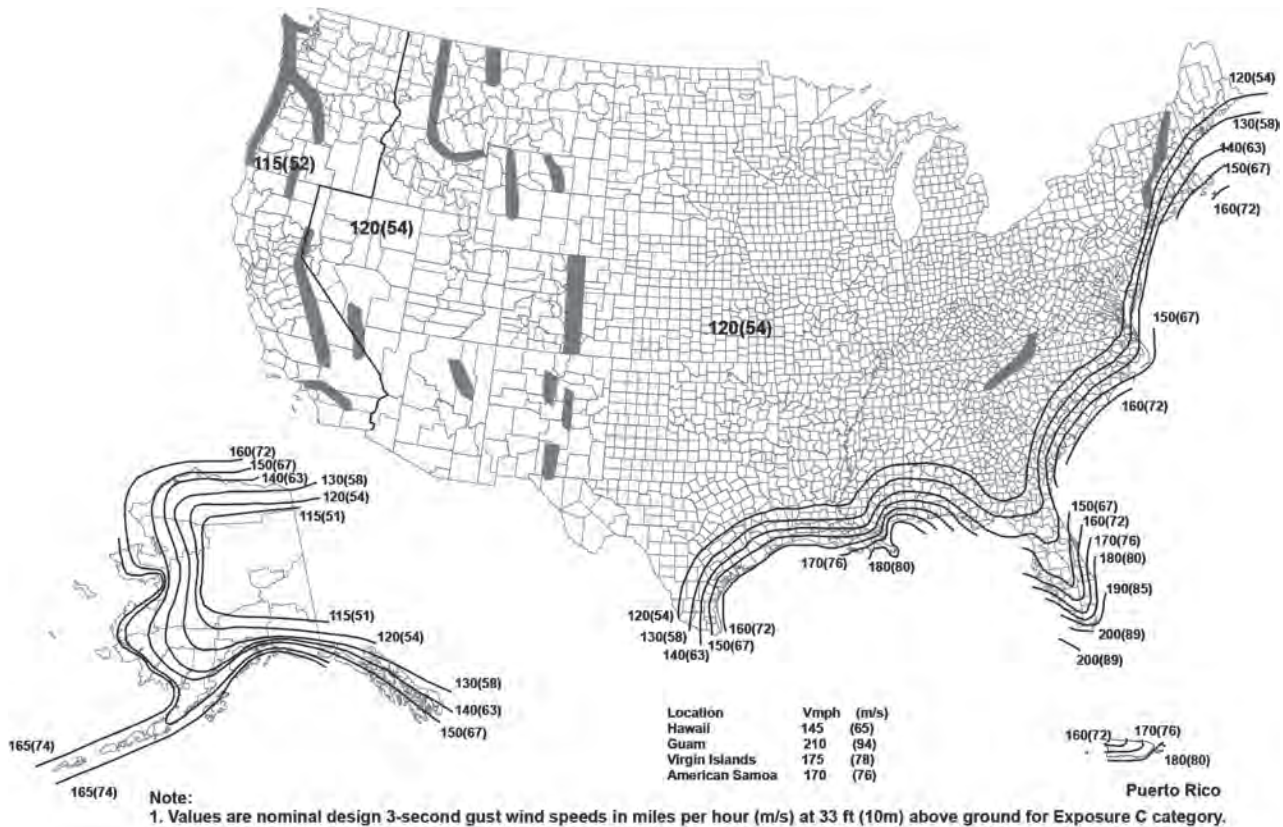

Figure 6-5: Basic wind speeds for Risk Category III and IV buildings and other structures

SOURCE: ASCE 7-10

As shown on Figure 6-5, for Risk Category III and IV buildings, most of the United States has a basic wind speed (peak gust) of 120 mph, but much higher speeds occur in Alaska and in hurricane-prone regions. The highest speed, 210 mph, occurs in Guam.

Hurricane-prone regions include Atlantic and Gulf coastal areas (where the basic wind speed is greater than 120 mph on the map shown in Figure 6-5), Hawaii, and the U.S. territories in the Caribbean and South Pacific. The boundary of the Atlantic and Gulf coast hurricane-prone region shifted towards the coast in the 2010 edition of ASCE 7 because of improvements in the hurricane simulation model (see Figure 6-2).

The MWFRS is an assemblage of structural elements assigned to provide support and stability for the overall structure. The system generally receives wind loading from more than one surface. The C&C are elements of the building envelope that do not qualify as part of the main wind-force resisting system.

In the ASCE 7 formula for determining wind pressures, the basic wind speed is squared. Therefore, as the wind speed increases, the pressures are exponentially increased, as illustrated in Figure 6-6. This figure also illustrates the relative difference in pressures exerted on the main wind-force resisting system (MWFRS) and the components and cladding (C&C) elements.

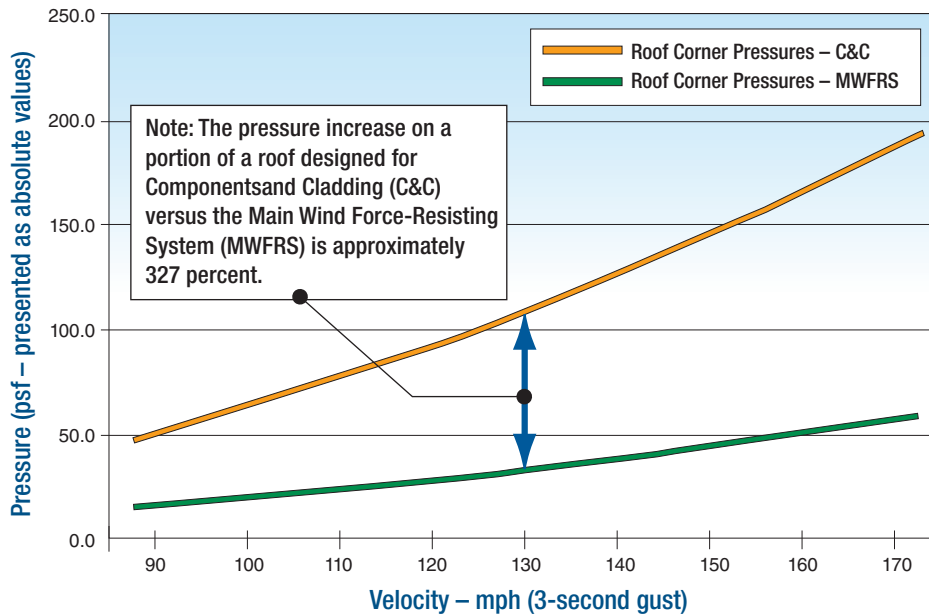

Figure 6-6:  
Wind pressure as a  
function of wind speed

**Building shape:** The highest uplift pressures occur at roof corners because of building aerodynamics (i.e., the interaction between the wind and the building). The roof perimeter has a somewhat lower load compared to the corners, and the field of the roof has still lower loads. Exterior walls typically have lower loads than the roof. The ends (edges) of walls have higher suction loads than the portion of wall between the ends. However, when the wall is loaded with positive pressure, the entire wall is uniformly loaded. Figure 6-7 illustrates these aerodynamic influences. The negative values shown in Figure 6-7 indicate suction pressure acting upward from the roof surface and outward from the wall surface. Positive values indicate positive pressure acting inward on the wall surface.

Aerodynamic influences are accounted for by using external pressure coefficients in load calculations. The value of the coefficient is a function of the location on the building (e.g., roof corner or field of roof) and building shape as discussed below. Positive coefficients represent a positive (inward-acting) pressure, and negative coefficients represent negative (outward-acting [suction]) pressure. External pressure coefficients for MWFRS and C&C are listed in ASCE 7.

Building shape affects the value of pressure coefficients and, therefore, the loads applied to the various building surfaces. For example, the uplift loads on a low-slope roof are larger than the loads on a gable or hip roof. The steeper the slope, the lower the uplift load. Pressure coefficients for monoslope (shed) roofs, sawtooth roofs, and domes are all different from those for low-slope and gable/hip roofs.



Building irregularities, such as re-entrant corners, bay window projections, a stair tower projecting out from the main wall, dormers, and chimneys can cause localized turbulence. Turbulence causes wind speed-up, which increases the wind loads in the vicinity of the building irregularity, as shown in Figures 6-8 and 6-9. Figure 6-8 shows the aggregate ballast on a building's single-ply membrane roof blown away at the re-entrant corner and in the vicinity of the corners of the wall projections at the window bays. The irregular wall surface created turbulence, which led to wind speed-up and loss of aggregate in the turbulent flow areas.

**Figure 6-7:**  
Relative roof uplift pressures as a function of roof geometry, roof slope, and location on roof, and relative positive and negative wall pressures as a function of location along the wall

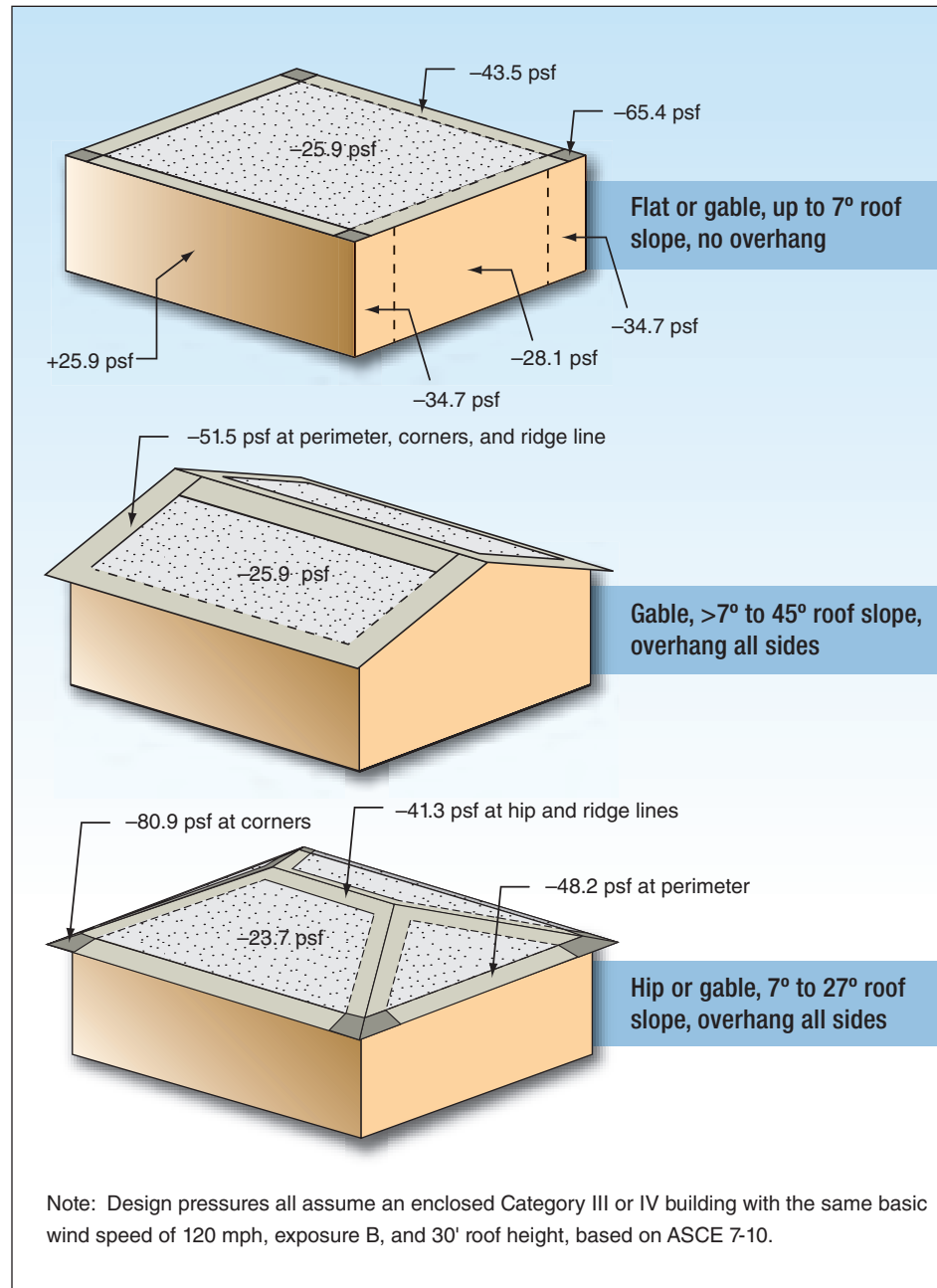



**Figure 6-8:**  
Aggregate blow-off associated with building irregularities. Hurricane Hugo (South Carolina, 1989)



**Figure 6-9:**  
The irregularity created by the stair tower (covered with a metal roof) caused turbulence resulting in wind speed-up and roof damage. Hurricane Andrew (Florida, 1992)

Figure 6-9 shows a building stair tower that caused turbulence resulting in wind speed-up. The speed-up increased the suction pressure on the base flashing along the parapet behind the stair tower. The built-up roof's base flashing was pulled out from underneath the coping because its attachment was insufficient to resist the suction pressure. The base flashing failure propagated and caused a large area of the roof membrane to lift and peel. Some of the wall covering on the stair tower was also blown away. Had the stair tower not existed, the built-up roof would likely not have been damaged. To avoid damage in the vicinity of building irregularities, attention needs to be given to the attachment of building elements located in turbulent flow areas.

Information pertaining to load calculations is presented in Section 6.3.1.2. For further general information on the nature of wind and wind-building interactions, see *Buildings at Risk: Wind Design Basics for Practicing Architects* (American Institute of Architects, 1997).

To avoid the roof membrane damage shown in Figure 6-9, it would be prudent to use corner uplift loads in lieu of perimeter uplift loads in the vicinity of the stair tower, as illustrated in Figure 6-10. Wind load increases due to building irregularities can be identified by wind tunnel studies; however, wind tunnel studies are rarely performed for schools. Therefore, identification of wind load increases due to building irregularities is normally based on the designer's professional judgment. Usually load

increases only need to be applied to the building envelope, and not to the MWFRS.

**Figure 6-10:** Plan view of a portion of the building in Figure 6-9 showing the use of a corner uplift zone in lieu of a perimeter uplift zone on the low-slope roof in the vicinity of the stair tower

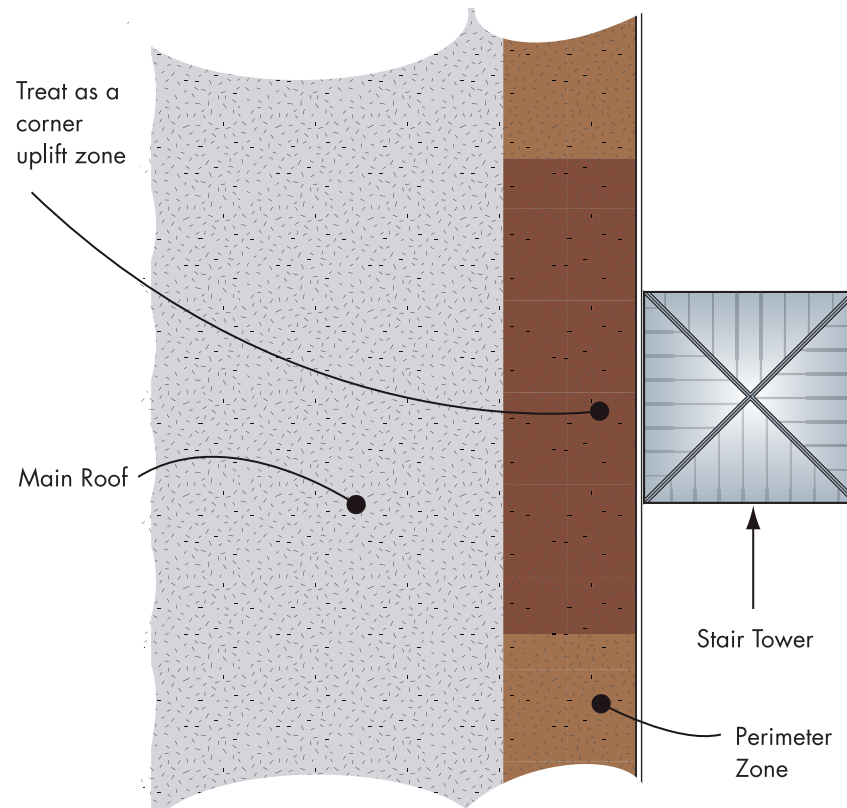

### 6.1.4 Building Codes

The IBC is the most extensively used model code. However, in some jurisdictions, one of the earlier model building codes, or a specially written State or local building code, may be used. The specific scope and/or effectiveness and limitations of these other building codes are somewhat different from those of the IBC. It is incumbent upon the design professionals to be aware of the specific code (including the edition of the code and local amendments) that has been adopted by the authority having jurisdiction over the location of the school.

#### 6.1.4.1 Scope of Building Codes

With respect to wind performance, the scope of the model building codes has greatly expanded since the mid-1980s. Some of the most significant improvements are discussed below.

**Recognition of increased uplift loads at the roof perimeter and corners:** Prior to the 1982 edition of the Standard Building Code (SBC) and the Uniform Building Code (UBC), and the 1987 edition of the National Building Code (NBC), these model codes did not account for the increased uplift at the roof perimeter and corners. Therefore, schools designed in accordance with earlier editions of these codes are very susceptible to blow-off of the roof deck and/or roof covering.

**Adoption of ASCE 7 for design wind loads:** Although the SBC, UBC, and NBC permitted use of ASCE 7, the 2000 edition of the IBC was the first model code to require ASCE 7 for determining wind design loads on all buildings. ASCE 7 has been more reflective of the current state of the knowledge than the earlier model codes, and use of this procedure typically has resulted in higher design loads.

**Roof coverings:** Several performance and prescriptive requirements pertaining to wind resistance of roof coverings have been incorporated into the model codes. The majority of these additional provisions were added after Hurricanes Hugo (1989) and Andrew (1992). Poor performance of roof coverings was widespread in both of those storms. Prior to the 1991 edition of the SBC and UBC, and the 1990 edition of the NBC, these model codes were essentially silent on roof covering wind loads and test methods for determining uplift resistance. Code improvements continued to be made through the 2006 edition of the IBC, which added a provision that prohibits aggregate roof surfaces in hurricane-prone regions.

**Glazing protection:** The 2000 edition of the IBC was the first model code to address wind-borne debris (missile) requirements for glazing in buildings located in hurricane-prone regions (via reference to the 1998 edition of ASCE 7). The 1995 edition of ASCE 7 was the first edition to address wind-borne debris requirements.

ASCE 7 requires impact-resistant glazing in wind-borne debris regions within hurricane-prone regions. Impact-resistant glazing can either be laminated glass, polycarbonate, or shutters tested in accordance with standards specified in ASCE 7. The wind-borne debris load criteria were developed to minimize property damage and to improve building performance. The criteria were not developed for occupant protection. Where occupant protection is a specific criterion, the more conservative wind-borne debris criterion given in FEMA 361, *Design and Construction Guidance for Community Shelters*, is recommended.



**Parapets and rooftop equipment:** The 2003 edition of the IBC was the first model code to address wind loads on parapets and rooftop equipment (via reference to the 2002 edition of ASCE 7, which was the first edition of ASCE 7 to address these elements).

**High-wind shelters:** The 2009 edition of the IBC was the first model code to adopt the new ICC 500. See Section 6.5 for further discussion of ICC 500.

#### 6.1.4.2 Effectiveness and Limitations of Building Codes

A key element of an effective building code is for a community to have an effective building department. Building safety depends on more than the codes and the standards they reference. Building safety results when trained professionals have the resources and ongoing support they need to stay on top of the latest advancements in building safety. An effective building safety system provides uniform code interpretations, product evaluations, and professional development and certification for inspectors and plan reviewers. Local building departments play an important role in helping to ensure buildings are designed and constructed in accordance with the applicable building codes. Meaningful plan review and inspection by the building department are particularly important for schools.

General limitations to building codes include the following:

- Because codes are adopted and enforced on the local or State level, the authority having jurisdiction has the power to eliminate or modify wind-related provisions of a model code, or write its own code instead. In places where important wind-related provisions of the current model code are not adopted and enforced, schools are more susceptible to wind damage. Additionally, a significant time lag often exists between the time a model code is updated and the time it is implemented by the authority having jurisdiction. Buildings designed to the minimum requirements of an outdated code are, therefore, not taking advantage of the current state of the knowledge. These buildings are prone to poorer wind performance compared to buildings designed according to the current model code.
- Adopting the current model code alone does not ensure good wind performance. The code is a minimum that should be used by knowledgeable design professionals in conjunction with their training, skills, professional judgment, and the best practices presented in this manual. To achieve good wind performance, in addition to good design, the construction work must be effectively executed, and the building must be adequately maintained and repaired.
- Schools need to perform at a higher level than required by codes and standards.

**IBC 2009:** The 2009 edition of the IBC is believed to be a relatively effective code, provided that it is properly followed and enforced. However, with respect to hurricanes, the IBC provisions pertaining to building envelopes and rooftop equipment do not adequately address the special needs of schools. For example, the following is a list of items that need to be addressed through the use of best practices:

- They do not account for water infiltration due to puncture of the roof membrane by missiles (see Figure 6-11)
- They do not adequately address the vulnerabilities of brittle roof coverings (such as tile) to missile-induced damage and subsequent progressive failure
- For schools used as hurricane recovery centers after a hurricane, they do not account for interruption of water or sewer service or prolonged interruption of electrical power.



**Figure 6-11:** The single-ply roof membrane on this school was torn by a missile. The tear was still unprotected 6 days after it was damaged. A substantial amount of water can enter the building through such a tear, unless the deck is water tight (see Figure 6-13) or a secondary roof membrane is used as discussed in Section 6.3.3.7. Estimated wind speed: 105 to 115 mph. Hurricane Ivan (Florida, 2004)

Addressing the first two elements is important for ensuring that the buildings are in suitable condition for school to resume within a couple of weeks after a hurricane. The last element is important for schools that will be used for recovery centers. Guidance for addressing these elements where they are not adequately addressed in IBC is provided in Sections 6.3 and 6.4.



- The 2000, 2003, 2006, and 2009 IBC rely on several referenced standards and test methods developed or updated in the last two decades. Prior to adoption, most of these standards and test methods had not been validated by actual building performance during design level wind events. The hurricanes of 2004, 2005, and 2008 provided an opportunity to evaluate the actual performance of buildings designed and constructed to the minimum provisions of the IBC. Building performance evaluations conducted by FEMA revealed the need for further enhancements to the 2009 IBC pertaining to some of the test methods used to assess wind and wind-driven rain resistance of building envelope components. For example, there is no test method to assess wind resistance of gutters. Further, the test method to evaluate the resistance of windows to wind-driven rain is inadequate for high wind events. However, before testing limitations can be overcome, research needs to be conducted, new test methods need to be developed, and some existing test methods need to be modified. Guidance to address shortcomings in standards and test methods is provided in Sections 6.3 and 6.4.
- The 2009 IBC Section 1614 is a new provision that addresses structural integrity (i.e., requirements for continuity, redundancy, or energy-dissipating capability [ductility] to limit the effects of local collapse, and to prevent or minimize progressive collapse after the loss of one or two primary structural members, such as a column). However, the Section only pertains to Category III and IV high-rise buildings. Although schools are not required to comply with this Section, this manual recommends that school designers consider the criteria in Section 1614.
- Except for storm shelters, the 2009 IBC does not account for tornadoes; therefore, except for weak tornadoes, it is ineffective for this type of storm.<sup>5</sup> Guidance to overcome this shortcoming is given in Section 6.5.

---

<sup>5</sup> Except for glass breakage, code-compliant buildings should not experience significant damage during weak tornadoes.

## 6.2 Schools Exposed to High Winds

### 6.2.1 Vulnerability: What High Winds Can Do to Schools

This section provides an overview of the common types of wind damage and their ramifications.

#### 6.2.1.1 Types of Building Damage

When damaged by wind, schools typically experience a variety of building component damage. For example, at the school shown in Figure 6-12, the roof covering was severely damaged, metal wall panels were blown off, and rooftop equipment was blown away. Water entered the building at all of these envelope breaches. The most common types of damage are discussed below in descending order of frequency.



**Figure 6-12:** Constructed in 1995, this school was used as a hurricane shelter. The large number of occupants moved from one area of the school to another as water entered various areas of the building due to envelope failures. Estimated wind speed: 105 to 115 mph. Hurricane Ivan (Florida, 2004)

**Roof:** Roof covering damage (including rooftop mechanical, electrical, and communications equipment) is the most common type of wind damage, as illustrated by Figure 6-13. At this school, a portion of the built-up membrane lifted and peeled after the metal edge flashing lifted. The cast-in-place concrete deck kept most of the water from entering the building. Virtually all of the loose aggregate blew off the roof and broke many windows in nearby houses. This school was used as a hurricane shelter at the time of the blow-off.

**Figure 6-13:** Extensive roof covering and rooftop equipment damage occurred on this school. However, the cast-in-place concrete deck kept most of the water from entering the school. Hurricane Andrew (Florida, 1992)



**Glazing:** Exterior glazing damage is very common during hurricanes and tornadoes, but is less common during other storms. The glass shown in Figure 6-14 was broken by the aggregate from a built-up roof. The inner panes had several impact craters. In several of the adjacent windows, both the outer and inner panes were broken. The aggregate flew more than 245 feet.

**Figure 6-14:** The outer window panes were broken by aggregate from a built-up roof. Estimated wind speed: 104 mph. Hurricane Hugo (South Carolina, 1989)





**Wall coverings, soffits, and large doors:** Exterior wall covering, soffit, and large door damage is common during hurricanes and tornadoes, but is less common during other storms. At the school shown in Figure 6-15, metal wall panels were blown off the gable end wall, thereby allowing wind-driven rain to enter the building.

**Wall collapse:** Collapse of non-load-bearing exterior walls is common during tornadoes, but is less common during other storms. At the school shown in Figure 6-16, the unreinforced CMU wall collapsed during a hurricane.



**Figure 6-15:** Blow-off of metal wall panels allowed wind-driven rain to enter this school. Hurricane Frances (Florida, 2004)



**Figure 6-16:** Collapsed unreinforced CMU wall. Hurricane Marilyn (U.S. Virgin Islands, 1995)

**Structural system:** Structural damage (e.g., roof deck blow-off, blow-off or collapse of the roof structure, collapse of exterior bearing walls, or collapse of the entire building or major portions thereof) is the principal type of damage that occurs during strong and violent tornadoes (see Figure 6-17). Structural damage occasionally occurs during hurricanes (Figures 6-18, 6-21, 6-24, 6-26, and 6-34). Portable classrooms are also sometimes severely damaged or overturned as shown in Figure 6-19.

Figure 6-17:  
The roof and all of the walls of a wing of this elementary school were blown away by a violent tornado. (Oklahoma City, 1999)



Figure 6-18:  
This elementary school was composed of several buildings. The building in the foreground collapsed and several others experienced significant structural damage. The buildings further up the hillside are residences. Hurricane Marilyn (U.S. Virgin Islands, 1995)







**Figure 6-19:** This portable classroom was blown up against the main school building. Depending upon the type of exterior wall, an impacting portable classroom may or may not cause wall collapse. Hurricane Marilyn (U.S. Virgin Islands, 1995)

### 6.2.1.2 Ramification of Damage

The ramifications of building component damage on schools are described below.

**Property damage:** Property damage requires repairing/replacing the damaged components (or replacing the entire facility), and may require repairing/replacing interior building components, furniture, and other equipment, books, and mold remediation. As illustrated by Figures 6-11, 6-12, 6-13, and 6-20, even when damage to the building envelope is limited, such as blow-off of a portion of the roof or wall covering or broken glazing, substantial water damage frequently occurs because heavy rains often accompany strong winds (particularly in the case of thunderstorms, tropical storms, hurricanes, and tornadoes).

Wind-borne debris such as roof aggregate, gutters, rooftop equipment, and siding blown from buildings can damage vehicles and other buildings in the vicinity. Debris can travel well over 300 feet in high-wind events.

Ancillary buildings (such as storage or shop buildings) adjacent to schools are also vulnerable to damage. Although loss of these buildings may not be crippling to the operation of the school, debris from ancillary buildings may strike and damage the school (Figure 6-21).

Modest wind speeds can drive rain into exterior walls. Unless adequate provisions are taken to account for water infiltration (see Sections 6.3.3.1–6.3.3.5), damaging corrosion, dry rot, and mold can occur within the walls.

**Figure 6-20:**  
This newly-constructed gymnasium had a structural metal roof panel (3-inch trapezoidal ribs at 24 inches on center) applied over metal purlins. The panels detached from their concealed clips. A massive quantity of water entered the school and buckled the wood gym floor. Typhoon Paka (Guam, 1997)



**Figure 6-21:**  
The entire metal deck and steel joist roof structure at this school's auto shop blew off. Estimated wind speed: 105 to 115 mph. Hurricane Ivan (Florida, 2004)



Portable classrooms are often particularly vulnerable to significant damage because they are seldom designed to the same wind loads as permanent school buildings. Portable classrooms are frequently blown over during high-wind events because of the inexpensive techniques typically used are inadequate to anchor the units to the ground (see Figures 6-19 and 6-22). Wind-borne debris from portables or an entire portable classroom may impact the permanent school building and cause serious damage (Figure 6-19).



**Figure 6-22:** The metal straps between this portable classroom and the ground anchors were not taut. This classroom is susceptible to being blown off the piers and to overturning. See Figure 6-27 for a robust anchoring system.

**Injury or death:** Although infrequent, school occupants or people outside schools have been injured and killed when struck by collapsed building components (such as exterior masonry walls or the roof structure) or wind-borne debris. The greatest risk of injury or death is during strong hurricanes and strong/violent tornadoes. The old school shown in Figure 6-23 was used as a hurricane shelter, even though it was not originally designed or subsequently retrofitted (i.e., mitigated) to serve as a shelter. The roof structure was composed of cementitious wood-fiber panels over steel joists. In the era when this building was constructed, these types of panels typically had very limited uplift resistance in perimeter and corner areas. Also, steel joists in that era typically offered limited uplift resistance. Structural failure was avoided not because of the strength of the building, but rather, because winds at the site were not as strong as they reasonably could have been expected to be.

People are not usually outside a school during hurricanes. However, when schools are used as hurricane shelters, it is common for people to arrive at schools during very high winds. Missiles such as roof aggregate or tile shedding from a school could injure or kill late arrivals to the shelter.

Also, students arriving at or departing from a school could be vulnerable. A 1967 tornado killed 13 students at the Belvedere High School in northern Illinois and seriously injured many others. School had been dismissed shortly before the tornado struck and many students were in school buses as the tornado approached the school. Although an attempt was made to get the students back inside the school, 12 of the buses were thrown about by the tornado before the students could seek shelter within the school. Aggregate from the school's built-up roof penetrated the flesh of several students.



**Figure 6-23:** This old school was used as a hurricane shelter. Structural failure did not occur during this hurricane. However, portions of the roof covering were blown off, rooftop equipment was damaged, and many windows were broken by aggregate from the built-up roof (red arrow). Estimated wind speed: 130 mph. Hurricane Katrina (Mississippi, 2005)



**Interrupted use:** Depending upon the magnitude of wind and water damage, it can take days, months, or more than a year to repair the damage or replace a facility (see Figure 6-24). In addition to the costs associated with repairing/replacing the damage, other social and financial costs can be even more significant. Additional costs related to interrupted use of schools can include the cost of bussing students to alternative schools and/or rental of temporary facilities, and can be quite substantial.

There are also social and psychological factors, such as difficulties imposed on students, parents, faculty, and the administration during the time the school is not usable.



**Figure 6-24:**  
A portion of the roof structure blew off this school, and a portion of it collapsed into classrooms. Extensive water damage can cause such a school to be out of operation for a considerable period of time. Hurricane Marilyn (U.S. Virgin Islands, 1995)

## 6.2.2 Priorities, Costs, And Benefits: New Schools

Priorities, costs, and benefits of potential risk reduction measures should be evaluated before beginning the risk reduction design process. These factors, as discussed below, should be considered within the context of performance-based wind design as discussed in Section 2.7.

### 6.2.2.1 Priorities

The first priority in risk reduction is the implementation of measures that will reduce risk of casualties to students, faculty, staff, and visitors. The second priority is the reduction of damage that leads to downtime and disruption. The third priority is the reduction of damage and repair costs. To realize these priorities, the school should be designed and constructed, as a minimum, in accordance with the latest edition of a current model building code such as the IBC unless the local building code has more conservative wind-related provisions, in which case the local building code should be used as the basis for design. In addition, the school should be adequately maintained and repaired.



The benefit-cost ratio of incorporating specially designed tornado safe rooms within schools can be assessed using software that accompanies the FEMA BCA Toolkit and the FEMA BCA Software (version 4.5.4). Tornado shelters have been constructed in several schools in Kansas, Oklahoma, and a few other States. An architect involved with several of the Kansas schools reports that the additional cost to incorporate a shelter ranges from about \$40.50 to \$51.50 per square foot (psf) of shelter space (year 2010 costs). Oftentimes as the safe room is small compared to the entire school, this results in only a 1 to 3 percent increase to total project cost. FEMA 361 recommends using a minimum of 5 square feet per person for sheltering; therefore, the \$40.50 to \$51.50 psf equates to about \$200 to \$260 per student and staff for “near absolute protection” (i.e., protection from injury or death) from a violent tornado. Tornado safe rooms and shelters are discussed in Section 6.5.

The increase in costs to construct a safe room for the hurricane hazard has a much more significant variation. This is because of the great variation of basic wind speeds in hurricane-prone regions. Hence, the incremental costs in the highest wind speed areas are much less than the costs in the lower wind speed areas. See FEMA 361, Chapter 2.<sup>7</sup>

For schools that will be used for emergency response after a storm and/or those schools that will be used for hurricane shelters, measures beyond those required by the IBC should be given high priority (see Section 6.5).

For schools located in tornado-prone regions, the incorporation of specially designed occupant shelters within the school (see Section 6.5) should be given priority. The decision to incorporate occupant shelters should be based on the assessment of risk (see Section 6.5).

For schools located in areas where the basic wind speed is greater than 120 mph, the incorporation of design, construction, and maintenance enhancements should be given priority.<sup>6</sup> The degree of priority given to these enhancements increases as the basic wind speed increases (see Step 4: Peer Review in Section 6.3.1.2 and Sections 6.3.2, 6.3.3 and 6.3.4 for enhancement examples).

#### 6.2.2.2 Cost, Budgeting, and Benefits

The cost to comply with the IBC should be considered as the minimum baseline cost.

For schools that will be used for emergency response after a storm and/or schools that will be used for hurricane shelters, the additional cost for implementing measures beyond those required by the 2009 edition of the IBC will typically add only a small percentage to the total cost of construction. Sections 6.3, 6.3.4, 6.4, and 6.5 discuss additional measures that should be considered.

6 The 120-mph basic wind speed is based on ASCE 7-10, Risk Category III and IV buildings. If ASCE 7-05 or an earlier version is used, the equivalent wind speed trigger is 90 mph.

7 FEMA 361 is a manual for architects and engineers. It presents detailed guidance concerning the design and construction of safe rooms that provide “near-absolute protection” from tornadoes and hurricanes (see Section 6.5 for the distinction between shelters and safe rooms). FEMA 361 discusses safe room location, design loads for wind pressure and wind-borne debris, performance criteria, and human factor criteria. It is accompanied by a benefit-cost model.

For all other schools, the additional cost for implementing enhancements will typically add only a very small percentage to the total cost of construction. Sections 6.3 to 6.4 discuss additional measures that should be considered.

The yearly cost of periodic maintenance and repair is greater than the alternative of not expending any funds for periodic maintenance (i.e., deferred maintenance and repair). The extent and cost of the deferred maintenance and repair is typically much greater over the long term. Also, if a windstorm causes damage that would have otherwise been avoided had maintenance or repairs been performed, the resulting costs can be significantly higher. (Note: Maintenance and repair costs are reduced when more durable materials and systems are used; see Section 6.3.1.2, under Step 3, Durability.)

**Budgeting:** School districts should give consideration to wind enhancement costs early in the development of a new school project. If enhancements, particularly those associated with schools used as hurricane shelters, for emergency response after a storm, and as tornado shelters, are not included in the initial project budget, often it is very difficult to find funds later during the design of the project. If the additional funds are not found, the enhancements may be eliminated because of lack of forethought and adequate budgeting.

**Benefits:** If strong storms do not occur during the life of a school, money and effort spent on wind resistance provide little benefit. However, considering the long life of most schools (hence, the greater probability of experiencing a design level event) and the importance of schools to the community, investing in adequate wind resistance is prudent. The potential for loss of life and injuries can be significantly reduced or virtually eliminated. Investing in wind resistance also minimizes future expenditures for repair or replacement of wind-damaged schools and avoids costly interruptions to building use.

Fortunately, most of the enhancements for increased wind resistance are relatively inexpensive compared to the benefits that they provide. Enhancements that provide greater performance reliability at a lower cost should be considered. For the building shown in Figure 6-25, a few inexpensive fasteners would have prevented costly repairs and interrupted use of a portion of the building. After the HVAC unit blew off the roof curb and landed in the parking lot, a substantial amount of water entered the building before a temporary covering could be placed over the opening. The blow-off was caused by a load path discontinuity; no provisions had been made to anchor the unit to the curb. The insignificant cost of a few fasteners would have prevented

repairs costing several thousand dollars and also prevented interrupted use of a portion of the building.

Wind resistance enhancements may also result in decreased insurance premiums. School districts should consult their insurer to see if premium reductions are available, and to see if special enhancements are required in order to avoid paying a premium for insurance. For those school districts that self-insure, enhanced wind resistance should result in a reduction of future payouts.

**Figure 6-25:**  
Lack of fasteners  
resulted in blow-off of  
the HVAC unit, which  
caused extensive  
interior water damage  
and interrupted facility  
use. Hurricane Marilyn  
(U.S. Virgin Islands,  
1995)



### 6.2.3 Priorities, Costs, and Benefits: Existing Schools

Priorities, costs, and benefits of potential risk reduction measures should be evaluated before beginning the risk reduction design process. These factors, as discussed below, should be considered within the context of performance-based wind design as discussed in Section 2.7.

#### 6.2.3.1 Priorities

School districts should assess schools for all applicable hazards to determine which schools are vulnerable to damage and most in need of remedial work. The highest priority work may or may not be related to wind. In some instances, the same remedial work may mitigate multiple hazards. For example, strengthening a roof deck attachment can improve both wind and seismic resistance.

School districts located in the following areas (listed in descending order of priority) are at the greatest risk for wind damage: hurricane-prone regions and school districts outside of hurricane-prone regions that have schools that will be used for emergency response after a storm; tornado-prone regions; areas where the basic wind speed is in excess of 120 mph (the priority increases as the basic wind speed increases); and areas where the basic wind speed is 120 mph or less.<sup>8</sup>

For school districts in hurricane-prone regions, schools that will be used as hurricane shelters should be the highest priority. Other priorities are as discussed at the beginning of Section 6.2.2.1. For school districts in tornado-prone regions, occupant protection (see Section 6.5) should be the highest priority. Other priorities are as discussed at the beginning of Section 6.2.2.1. For all other school districts, the priorities are the same as discussed at the beginning of Section 6.2.2.1.

In some instances, all the available funds for remedial work may be spent at one school. In other instances, the available funds may be used for remedial work at several schools.

See Section 6.4 for specific remedial work guidance.

### 6.2.3.2 Cost, Budgeting, and Benefits

Wind-resistance improvements should ideally address all elements in the load path from the building envelope to the structural system and into the ground (Load path is discussed in Section 6.3.1.2 under Step 3, Detailed Design). However, this approach can be very expensive if there are many inadequacies throughout the load path. The maximum return on investment for wind-resistance improvements is typically for enhancements to the building envelope. Obviously if there are serious structural deficiencies that could lead to collapse during strong storms, these types of deficiencies should receive top priority; however, this scenario is infrequent.

Because elements of the building envelope are the building components most likely to fail in the more common moderate wind speed events, strengthening these elements will avoid damage during those storms. In a storm approaching a design level event, the building envelope will remain attached to the structure, but a structural element may fail. For example, if the connections between the roof joists and bearing walls are the weak link, the roof covering will remain attached to the roof deck and the deck will remain attached to the joists, but the entire roof structure will blow off because the joists will detach from the wall. Although

---

<sup>8</sup> The 120-mph basic wind speed is based on ASCE 7-10, Risk Category III and IV buildings. If ASCE 7-05 or an earlier version is used, the equivalent wind speed trigger is 90 mph.



loss of the entire roof structure is more catastrophic than the loss of just the roof covering, much stronger events are typically required to cause structural damage. Hence, on a school district-wide level, strengthening building envelopes will likely result in the maximum return for wind-resistance improvements. Of course, for a specific school, the scope of wind-resistance work should be tailored to each school, commensurate with the findings from the hazard assessment (as discussed in Section 6.2.4.2) and the benefit-cost analysis (discussed below).

Costs can be minimized if wind-resistance improvements are executed as part of planned repairs or replacement. For example, if the roof deck is inadequately attached in the perimeter and corners (see Figure 6-26), and the roof covering has another 10 years of remaining service life, it would typically be prudent to postpone performing deck attachment upgrade until it is necessary to replace the roof covering. Then, as part of the reroofing work, the existing roof system could be torn off, the deck reattached or replaced, and the new membrane installed.<sup>9</sup> This approach provides the cost benefit of utilizing the full service life of the roof membrane.

**Figure 6-26:** The cementitious wood-fiber deck panels blew off the overhangs and caused a progressive lifting and peeling of the roof membrane. Strengthening (or replacing) inadequately attached roof decks during a reroofing project is both prudent and relatively economical. Estimated wind speed: 120 mph. Hurricane Katrina (Mississippi, 2005)



**Budgeting:** As with new construction, school districts should give consideration to wind enhancement costs early in the development of a major repair/renovation project (see discussion in Section 6.2.2.2).

<sup>9</sup> In some cases, reattaching the decking from below the deck may be more economical, but typically this approach is more costly.



**Benefits:** The benefits of money and effort spent on wind resistance for existing schools are the same as described for new schools in Section 6.2.2.2.

## 6.2.4 Evaluating Schools for Risk from High Winds

This section describes the process of hazard risk assessment. Although no formal methodology for risk assessment has been adopted, prior experience provides sufficient knowledge upon which to base a recommended procedure for risk assessment of schools. The procedures presented below establish guidelines for evaluating the risk to new and existing buildings from windstorms other than tornadoes. These evaluations will allow development of a vulnerability assessment that can be used along with the site's wind regime to assess the risk to schools.

In the case of tornadoes, neither the IBC nor ASCE 7 requires buildings (including schools) to be designed to resist tornado forces; nor are occupant shelters required in buildings located in tornado-prone regions.<sup>10</sup> Constructing tornado-resistant schools is extremely expensive because of the extremely high pressures and missile impact loads that tornadoes can generate. Therefore, when consideration is voluntarily given to tornado design, the emphasis is typically on occupant protection, which is achieved by “hardening” portions of a school for use as safe havens. FEMA 361 includes a comprehensive risk assessment procedure that designers can use to assist building owners in determining whether a tornado shelter should be included as part of a new school. See Section 6.5 for recommendations pertaining to best practices for incorporating safe rooms in schools in hurricane- and tornado-prone regions.

### 6.2.4.1 New Buildings

When designing new schools, a two-step procedure is recommended for evaluating the risk from windstorms (other than tornadoes).

**Step 1:** Determine the basic wind speed from ASCE 7. As the basic wind speed increases beyond 120 mph, the risk of damage increases.<sup>11</sup> Design, construction, and maintenance enhancements are recommended to compensate for the increased risk of damage (see Section 6.3).

---

<sup>10</sup> The 2009 edition of the IBC references ICC 500 for the design and construction of hurricane and tornado shelters. However, as discussed in Section 6.5, while ICC 500 specifies shelter criteria, it does not require shelters.

<sup>11</sup> The 120-mph basic wind speed is based on ASCE 7-10, Risk Category III and IV buildings. If ASCE 7-05 or an earlier version is used, the equivalent wind speed trigger is 90 mph.

As part of Steps 2 and 3, consider the availability of other schools or buildings in the community that could be used for educational purposes (and emergency response if the school is so designated) in the event that the school is damaged. For example, in an isolated community, the school may be the only facility available for education and/or emergency response, in which case loss of school use would be very serious. In this scenario, the enhancements given in Sections Sections 6.3.1.5, 6.3.2.2, 6.3.3.3, 6.3.3.5, 6.3.3.7, 6.3.4.2, 6.3.4.4, 6.3.5, and 6.3.6 should be followed and some of the enhancements should be even more robust.

**Step 2:** For schools not located in hurricane-prone regions, determine if the school will be used for emergency response after a storm (e.g., temporary housing, food or clothing distribution, or a place where people can fill out forms for assistance). If so, refer to the design, construction, and maintenance enhancements recommended for schools in hurricane-prone regions (see Sections 6.3.1.5, 6.3.2.2, 6.3.3.3, 6.3.3.5, 6.3.3.7, 6.3.4.2, 6.3.4.4, 6.3.5, and 6.3.6).

**Step 3:** For schools in hurricane-prone regions, refer to the design, construction, and maintenance enhancements recommended in Sections 6.3.1.5, 6.3.2.2, 6.3.3.3, 6.3.3.5, 6.3.3.7, 6.3.4.2, 6.3.4.4, 6.3.5, and 6.3.6

#### 6.2.4.2 Existing Buildings

The resistance of existing buildings is a function of their original design and construction, various additions or modifications, and the condition of building components (which may have weakened due to deterioration or fatigue). For existing buildings, a two-step procedure for evaluating the risk from windstorms (other than tornadoes) is also recommended.

**Step 1:** Calculate the wind loads on the building using the current edition of ASCE 7, and compare these loads with the loads for which the building was originally designed. The original design loads may be noted on the contract drawings. If not, calculate the loads using the code or standard to which the building was designed and constructed. If the original design loads are significantly lower than current wind loads, upgrading the load resistance of the building envelope and/or structure should be considered (see Section 6.2.4.2). An alternative to comparing current loads with original design loads is to evaluate the resistance of the existing facility as a function of the current wind loads to determine what elements are highly overstressed.

**Step 2:** Perform a field investigation to evaluate the primary building envelope elements, rooftop equipment, and structural system elements, to determine if the school was generally constructed as indicated on the original contract drawings. As part of the investigation, the primary elements should be checked for deterioration. Load path continuity should also be checked.

The above evaluations will allow development of a vulnerability assessment that can be used along with the site's wind characteristics to assess the risk. If the results of either step indicate the need for remedial work, see Section 6.4.

### 6.2.4.3 Portable Classrooms

Unless portable classrooms are designed and constructed (including anchorage to the ground—see Figure 6-27) to meet the same wind loads as the main school building, students and faculty should be considered at risk during high winds. Therefore, portable classrooms should not be occupied when high winds are forecast (even though the forecast speeds are well below design wind conditions for the main building). Also, during winds that are well below design wind conditions, wind-borne debris from disintegrating portable classrooms could impact and damage the main school building and/or nearby residences (Figure 6-28).



**Figure 6-27:** Unlike the portable classroom shown in Figure 6-22, with the thick T-shaped plates and taut turnbuckles, this portable classroom has a robust anchorage to the ground. Hurricane Francis (Florida, 2004)

**Figure 6-28:**  
Asphalt shingles and vinyl siding blew off of this portable classroom. This type of wind-borne debris can break unprotected glazing. Hurricane Francis (Florida, 2004)



### 6.3 Requirements and Best Practices in High-Wind Regions

**T**he performance of schools in past wind storms indicates that the most frequent and the most significant factor in the disruption of the operations of these facilities has been the failure of nonstructural building components. While acknowledging the importance of the structural systems, Chapter 6 emphasizes the building envelope components and the nonstructural systems. According to National Institute of Building Sciences (NIBS), the building envelope includes the below-grade basement walls and foundation and floor slab (although these are generally considered part of the building's structural system). The envelope includes everything that separates the interior of a building from the outdoor environment, including the connection of all the nonstructural elements to the building structure. The nonstructural systems include all mechanical, electrical, electronic, communications, and lightning protection systems. Historically, damage to roof coverings and rooftop equipment has been the leading cause of building performance problems during windstorms. Special consideration should be given to the problem of water infiltration through failed building envelope components, which can cause severe disruptions in the functioning of schools.

The key to enhanced wind performance is paying sufficient attention to all phases of the construction process (including site selection, design,



and construction) and to post-occupancy maintenance and repair. Of course, the school district must first budget sufficient funds for these efforts (see Sections 6.2.2.2 and 6.2.3.2).

## School Design Considerations In Hurricane-Prone Regions

Following the general design and construction recommendations, this manual presents recommendations specific to schools located in hurricane-prone regions. These recommendations are additional to the ones presented for schools located outside of hurricane-prone regions, and in many cases supersede those recommendations. Schools located in hurricane-prone regions require special design and construction attention because of the unique characteristics of this type of windstorm. Hurricanes can bring very high winds that last for many hours, which can lead to material fatigue failures. The variability of wind direction increases the probability that the wind will approach the building at the most critical angle. Hurricanes also generate a large amount of wind-borne debris, which can damage various building components and cause injury and death. In order to ensure continuity of service during and after hurricanes, the design, construction, and maintenance of schools should be very robust to provide sufficient resiliency to withstand the effects of hurricanes.

Designing a portion of a school to be used as a safe room requires the designer to consider additional design criteria beyond what is presented in this chapter. To find the design criteria for a safe room in a school, refer to FEMA 361 and Section 6.5 of this document.

### 6.3.1 General School Design Considerations

#### 6.3.1.1 Site

When selecting land for a school, sites located in Exposure D (see ASCE 7 for exposure definitions) should be avoided if possible. Selecting a site in Exposure C or preferably in Exposure B decreases the wind loads. Also, where possible, avoid selecting sites located on an escarpment or the upper half of a hill, where the abrupt change in the topography would result in increased wind loads.<sup>12</sup>

Trees with trunks larger than 6 inches in diameter, poles (e.g., light fixture poles, flagpoles, and power poles), or towers (e.g., electrical transmission and large communication towers) should not be placed near the building. Falling trees, poles, and towers can severely damage a school and injure the occupants. Large trees can crash through pre-engineered metal buildings and wood frame construction (see Figure 6-29). Falling trees can also rupture roof membranes and break windows.

<sup>12</sup> When selecting a site on an escarpment or the upper half of a hill is necessary, the ASCE 7 design procedure accounts for wind speed-up associated with this abrupt change in topography.



**Figure 6-29:** This fallen tree caused minor damage to these portable classrooms. However, had the tree landed on the classroom at the left of the photograph, it could have caused injuries if the building had been occupied. Although portable classrooms are not occupied during hurricanes, they are frequently occupied during thunderstorms, which often topple trees. Estimated wind speed: 105 to 115 mph. Hurricane Ivan (Florida, 2004)



Street signage should be designed to resist the design wind loads so that toppled signs do not block access roads or become wind-blown debris. AASHTO LTS-4-5 provides guidance for determining wind loads on highway signs.

Providing at least two means of site egress is prudent for all schools, but is particularly important for schools in hurricane-prone regions. If one route becomes blocked by trees or other debris, or by floodwaters, the other access route may still be available.

To the extent possible, site portable classrooms so that, if they disintegrate during a storm that approaches from the prevailing wind direction, debris will avoid impacting the main school building and residences. Debris can travel in excess of 300 feet. Destructive winds from hurricanes and tornadoes can approach from any direction. These storms can also throw debris much farther.

### 6.3.1.2 School Design

Good wind performance depends on good design (including details and specifications), materials, installation, maintenance, and repair. A significant shortcoming in any of these five elements could jeopardize the performance of a school against wind. Design, however, is the key element to achieving good performance of a building against wind damage. Design inadequacies frequently cannot be compensated for with other elements. Good design, however, can compensate for other inadequacies to some extent. The following steps should be included in the design process for schools.

#### Step 1: Calculate Loads

Calculate loads on the MWFRS, the building envelope, and rooftop equipment in accordance with the latest edition of ASCE 7 or the local building code, whichever procedure results in the highest loads. In calculating wind loads, design professionals should consider the following items.

**Risk Category:** This manual recommends that all schools be classified as Risk Category III or IV buildings.

**Wind directionality factor:** The ASCE 7 wind load calculation procedure incorporates a wind directionality factor ( $K_d$ ). The directionality factor accounts for the reduced probability of maximum winds coming from any given direction. By applying the prescribed value of 0.85, the loads are reduced by 15 percent. Because hurricane winds can come from any direction, and because of the historically poor performance of building envelopes and rooftop equipment, this manual recommends a more conservative approach for schools in hurricane-prone regions. A directionality factor of 1.0 is recommended for the building envelope and rooftop equipment (a load increase over what is required by ASCE 7). For the MWFRS, a directionality factor of 0.85 is recommended (hence, no change for MWFRS).

For assistance in applying the provisions of ASCE 7, refer to the Applied Technology Council's (ATC) Design Guide 2, *Basic Wind Engineering for Low-Rise Buildings*. Topics include how to determine mean roof height for various building shapes, how to determine the building exposure, how to determine a building's enclosure category, and how to apply loads using the three analytical methods given in ASCE 7 in order to help the user understand the differences in and the sensitivities to these methods. This Guide is based on the 2005 edition of ASCE 7. A future edition of the Guide will be based on the 2010 edition of ASCE 7.

In the past, design professionals seldom performed load calculations on the building envelope (i.e., roof and wall coverings, doors, windows, and skylights) and rooftop equipment. These building components are the ones that have failed the most during past wind events. In large part, they failed because of the lack of proper load determination and inappropriate design of these elements. It is imperative that design professionals determine the loads for the building envelope and rooftop equipment, and design them to accommodate such loads.

The design wind loads for a Risk Category III or IV building are 15 percent greater than for Category II building. This load increase is intended to make Category III and IV buildings more capable of resisting the wind pressures induced by stronger, rarer hurricanes than Category II buildings.

Even if a school (or portion thereof) is hardened for improved wind resistance and damage reduction, the facility will not provide hurricane or tornado life-safety protection unless it has been designed and constructed to meet the criteria in FEMA 361 or the ICC 500. See Section 6.5.

Uplift loads on roof assemblies can also be determined from FM Global (FMG) Data Sheets (dates vary). If the school is FMG insured, and the FMG-derived loads are higher than those derived from ASCE 7 or the building code, the FMG loads should govern. However, if the ASCE 7 or code-derived loads are higher than those from FMG, the ASCE 7 or code-derived loads should govern (whichever procedure results in the highest loads).

When using allowable stress design, a safety factor is applied to account for reasonable variations in material strengths, construction workmanship, and conditions when the actual wind speed somewhat exceeds design wind speed. For design purposes, the ultimate resistance an assembly achieves in testing is reduced by the safety factor. For example, if a roof assembly resisted an uplift pressure of 100 pounds per square foot (psf), after applying a safety factor of 2, the assembly would be suitable where the design load after application of the load combination reduction factor was 50 psf or less.<sup>13</sup> Conversely, if the design load after application of the load combination is known, multiplying it by the safety factor equals the minimum required test pressure (e.g., 50 psf design load multiplied by a safety factor of 2 equals a minimum required test pressure of 100 psf).

## Step 2: Determine Load Resistance

When using allowable stress design, after loads have been determined, it is necessary to determine a reasonable safety factor in order to select the minimum required load resistance. For building envelope systems, a minimum safety factor of 2 is recommended. For anchoring exterior-mounted mechanical, electrical, and communications equipment (such as satellite dishes), a minimum safety factor of 3 is recommended. When using allowable stress design, refer to the load combinations specified in ASCE 7. When using strength design, load combinations and load factors specified in ASCE 7 are used.

For structural members and cladding elements where strength design can be used, load resistance can be determined by calculations. For other elements where allowable stress design is used (such as most types of roof coverings), load resistance is primarily obtained from system testing.

The load resistance criteria need to be provided in contract documents. For structural elements, the designer of record typically accounts for load resistance by indicating the material, size, spacing, and connection of the elements. For nonstructural elements, such as roof coverings or windows, the load and safety factor can be specified. In this case, the specifications should require the contractor's submittals to demonstrate that the system will meet the load resistance criteria. This performance specification approach is necessary if, at the time of the design, it is unknown who will manufacture the system.

Regardless of which approach is used, it is important that the designer of record ensure that it can be demonstrated, via calculations or tests, that the structure, building envelope, and nonstructural systems (exterior-mounted mechanical, electrical, and communications equipment) have sufficient strength to resist design wind loads.

<sup>13</sup> If the 2005 or earlier edition of ASCE 7 is used, the design wind load prior to application of



### Step 3: Detailed Design

It is vital to design, detail, and specify the structural system, building envelope, and exterior-mounted mechanical, electrical, and communications equipment to meet the factored design loads (based on appropriate analytical or test methods). It is also vital to respond to the risk assessment criteria discussed in Section 6.2.4, as appropriate.

As part of the detailed design effort, load path continuity should be clearly indicated in the contract documents via illustration of connection details. Load paths need to accommodate design uplift, racking, and overturning loads. Load path continuity obviously applies to MWFRS elements, but it also applies to building envelope elements. Figure 6-30 shows load path discontinuities within a roof covering system. In this system, metal roof panels were attached to plywood, which was attached to 4x4 nailers running cross-slope. These top nailers were attached to 4x4 nailers that ran up-slope. The top nailers were inadequately attached to the bottom nailers and the bottom nailers were inadequately attached to the roof structure. To effectively attach the top nailer to the bottom nailer, high-strength connectors such as metal framing connectors are needed. To effectively attach the bottom nailers, a variety of fasteners may be used, provided a sufficient number are used.

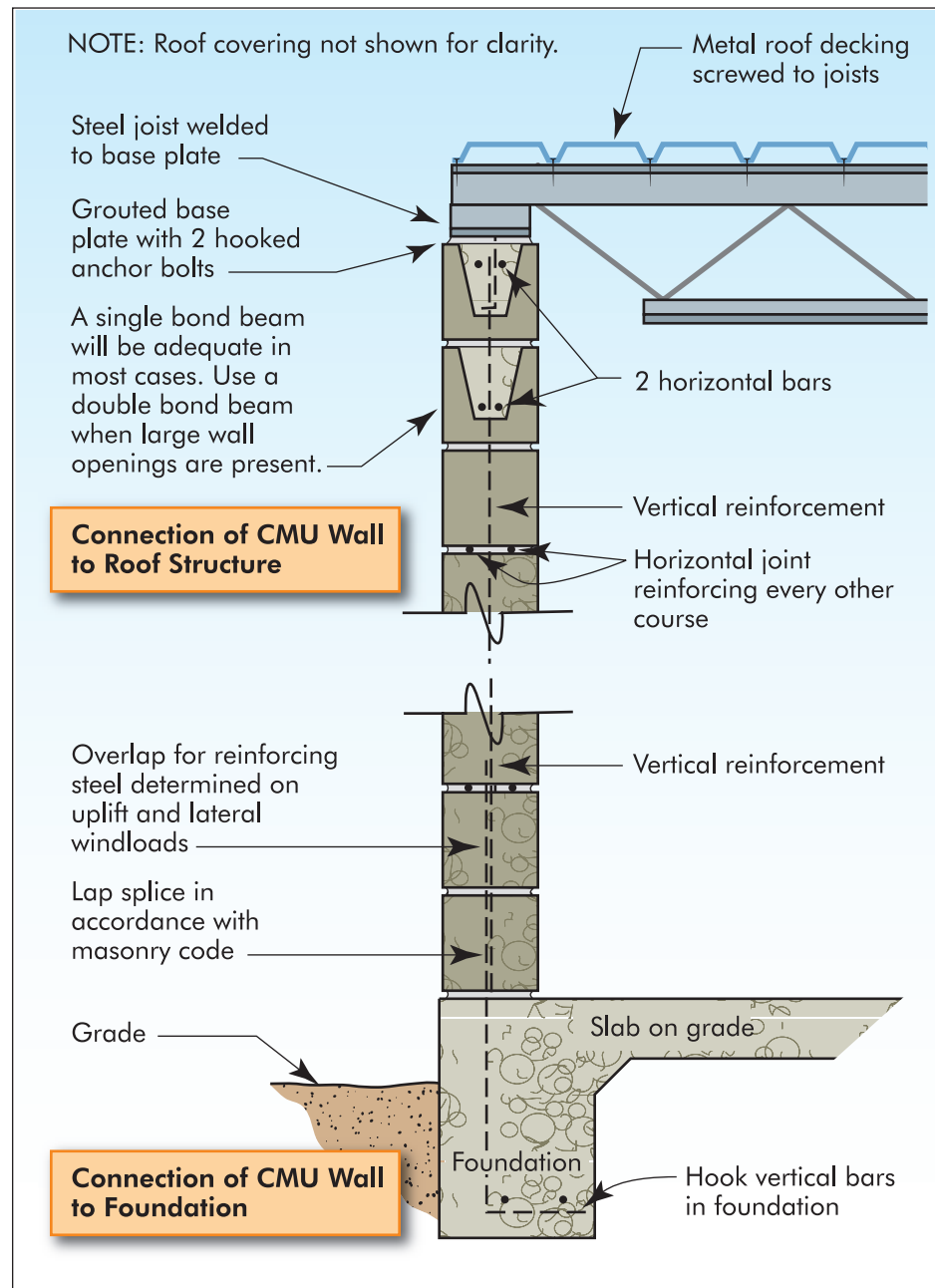

**Figure 6-30:** In most of the areas on this roof, the connection of the top nailer to the bottom nailer was the weakest link. However, in a few locations, the connection of the bottom nailer to the roof structure was the weak link (three of the blown-off bottom nailers are shown by the red lines).

Connections are a key aspect of load path continuity between various structural and nonstructural building elements. In a window, for example, the glass must be strong enough to resist the wind pressure and must be adequately anchored to the window frame, the frame adequately anchored to the wall, the wall to the foundation, and the foundation to the ground. As loads increase, greater load capacity must be developed in the connections.

Figure 6-31 illustrates the load path concept. Members are sized to accommodate the design loads. Connections are designed to transfer uplift loads applied to the roof, and the positive and negative loads applied to the exterior bearing walls, down to the foundation and into the ground. The roof covering (and wall covering, if there is one) is also part of the load path. To avoid blow-off, the nonstructural elements must also be adequately attached to the structure.

**Figure 6-31:**  
Illustration of load path continuity





As part of the detailed design process, special consideration should be given to the durability of materials and water infiltration.

**Durability:** Because some locales have very aggressive atmospheric corrosion (such as areas near oceans), special attention needs to be given to the specification of adequate protection for ferrous metals, or to specify alternative metals such as stainless steel. FEMA TB-8, *Corrosion Protection for Metal Connectors in Coastal Areas* (1996), contains information on corrosion protection. Attention also needs to be given to dry rot avoidance, for example, by specifying preservative-treated wood or developing details that avoid excessive moisture accumulation. Appendix J of FEMA 55, *Coastal Construction Manual* (2000), presents information on wood durability. Note: An updated version of FEMA 55 is expected to be released in 2011.

Durable materials are particularly important for components that are inaccessible and cannot be inspected regularly (such as fasteners used to attach roof insulation). Special attention also needs to be given to details. For example, details that do not allow water to stand at connections or sills are preferred. Without special attention to material selection and details, the demands on maintenance and repair will be increased, along with the likelihood of failure of components during high winds.

**Water infiltration (rain):** Although prevention of building collapse and major building damage is the primary goal of wind-resistant design, consideration should also be given to minimizing water damage and subsequent development of mold from the penetration of wind-driven rain. To the extent possible, non-load-bearing walls and door and window frames should be designed in accordance with rain-screen principles. With this approach, it is assumed that some water will penetrate past the face of the building envelope. The water is intercepted in an air-pressure equalized cavity that provides drainage from the cavity to the outer surface of the building. See Sections 6.3.3.1 and 6.3.3.4, and Figure 6-52 for further discussion and an example.

In conjunction with the rain-screen principle, it is desirable to avoid using sealant as the first or only line of defense against water infiltration. When sealant joints are exposed, obtaining long-lasting watertight performance is difficult because of the complexities of sealant joint design and installation (see Figure 6-52, which shows the sealant protected by a removable stop).

Further information on the rain-screen principle can be found in the National Institute of Building Sciences' *Building Envelope Design Guide* ([www.wbdg.org/design/envelope.php](http://www.wbdg.org/design/envelope.php)).

### Step 4: Peer Review

If the design team's wind expertise and experience is limited, wind design input and/or peer review should be sought from a qualified individual. The design input or peer review could be arranged for the entire building, or for specific components such as the roof or glazing systems, that are critical and beyond the design team's expertise.

When a room or portion of a school has been design per FEMA 361 to function as a safe room with an occupancy of 50 persons or more, a peer review must be performed for the safe room.

Regardless of the design team's expertise and experience, peer review should be considered when a school:

- is located in an area where the basic wind speed is greater than 120 mph (peak gust)<sup>14</sup>
- will be used for emergency response after a storm
- will be used for a hurricane shelter
- will incorporate a hurricane or tornado safe room or shelter

#### 6.3.1.3 Construction Contract Administration

After a suitable design is complete, the design team should endeavor to ensure that the design intent is achieved during construction. The key elements of construction contract administration are submittal reviews and field observations, as discussed below.

**Submittal reviews:** The specifications need to stipulate the submittal requirements. This includes specifying what systems require submittals (e.g., windows) and test data (where appropriate). Each submittal should demonstrate the development of a load path through the system and into its supporting element. For example, a window submittal should show that the glazing has sufficient strength, its attachment to the frame is adequate, and the attachment of the frame to the wall is adequate.

During submittal review, it is important for the designer of record to be diligent in ensuring that all required documents are submitted and that they include the necessary information. The submittal information needs to be thoroughly checked to ensure its validity. For example, if an approved method used to demonstrate compliance with the design load has been altered or incorrectly applied, the test data should be rejected, unless the contractor can demonstrate the test method was suitable. Similarly, if a new test method has been developed by a manufacturer or the contractor, the contractor should demonstrate its suitability.

<sup>14</sup> The 120-mph basic wind speed is based on ASCE 7-10, Risk Category III and IV buildings. If ASCE 7-05 or an earlier version is used, the equivalent wind speed trigger is 90 mph.

**Field observations:** It is recommended that the design team analyze the design to determine which elements are critical to ensuring high-wind performance. The analysis should include the structural system and exterior-mounted electrical equipment, but it should focus on the building envelope and exterior-mounted mechanical and communications equipment. After determining the list of critical elements to be observed, observation frequency and the need for special inspections by an inspection firm should be determined. Observation frequency and the need for special inspections will depend on the magnitude of the results of the risk assessment described in Section 6.2.4, the complexity of the facility, and the competency of the general contractor, subcontractors, and suppliers.

#### 6.3.1.4 Post-Occupancy Inspections, Periodic Maintenance, Repair, and Replacement

The design team should advise the school administration of the importance of periodic inspections, maintenance, and timely repair. It is important for the administration to understand that a facility's wind resistance will degrade over time due to exposure to weather unless it is regularly maintained and repaired. The goal should be to repair or replace items before they fail in a storm. This approach is less expensive than waiting for failure and then repairing the failed components and consequential damage.

Prior to hurricane landfall, a special roof inspection is recommended. Remove debris and other items that are not anchored so that they do not become wind-borne debris. Also, clean roof drains and sumps so that their drainage capacity is not impaired (see Figure 6-32). Lack of debris maintenance can lead to clogging. If overflow drains or scuppers are also clogged, roof collapse may occur.

The building envelope and exterior-mounted equipment should be inspected once a year by persons knowledgeable of the systems/materials they are inspecting. Items that require maintenance, repair, or replacement should be documented and scheduled for work. For example, the deterioration of glazing is often overlooked. After several years of exposure, scratches and chips can become extensive enough to weaken the glazing. Also, if an engineered film was surface-applied to glazing for wind-borne debris protection, the film should be periodically inspected and replaced before it is no longer effective.

A special inspection is recommended following unusually high winds (such as a thunderstorm with wind speeds of 70 mph peak gust or greater). The purpose of the inspection is to assess whether the storm caused damage that needs to be repaired to maintain building strength and integrity. In addition to inspecting for obvious signs of damage, the inspector should determine if cracks or other openings have developed that may allow water infiltration, which could lead to corrosion or dry rot of concealed components.

**Figure 6-32:**  
Dirt and vegetation surrounded this roof drain (red arrow) and impeded drainage. Roof drains should be checked at least annually and cleaned of debris if found. Drains should also be checked prior to hurricane landfall. Hurricane Ike (Texas, 2008)



### 6.3.1.5 Site and General Design Considerations in Hurricane-Prone Regions

Via ASCE 7, the 2009 edition of the IBC has only two special wind-related provisions pertaining to schools in hurricane-prone regions. One pertains to glazing protection within wind-borne debris regions (as defined in ASCE 7). The other provision pertains to schools that will be used as hurricane evacuation shelters. If used as shelters, schools must be designed as Risk Category IV buildings. These are the only hurricane-related school requirements currently in the IBC. These two additional requirements do not provide adequate protection of occupants of a school during a hurricane, nor do they ensure a school will be functional after a hurricane. Further, a school may comply with IBC, but still remain vulnerable to water and missile penetration through the roof or walls. To mitigate this water and missile vulnerability, see Sections 6.3.2.2, 6.3.3.3, 6.3.3.5, and 6.3.3.7.

During the design phase, the architect should determine from the school district whether or not the school will be designated or used as a hurricane evacuation shelter. If it will be used as a shelter, see Section 6.5 for design recommendations.

The following recommendations are made regarding siting:

- Locate poles, towers, and trees with trunks larger than 6 inches in diameter away from primary site access roads so that they do not block access to, or hit, the facility if toppled.
- Determine if existing buildings within 1,500 feet of the new facility have aggregate surfaced roofs. If roofs with aggregate surfacing are present, it is recommended that the aggregate be removed to prevent it from impacting the new facility. Aggregate removal may necessitate reroofing or other remedial work in order to maintain the roof's fire or wind resistance.
- In cases where a building on a school campus will be used as a hurricane safe room or shelter, if there are multiple buildings on campus, it is recommended that enclosed walkways be designed to connect the buildings. The enclosed walkways (above- or below-grade) are particularly important for protecting people moving between buildings during a hurricane if it becomes necessary to evacuate occupants from one building to another (see Figure 6-33).

Publication 4496 by the American Red Cross (ARC, 2002), *Standards for Hurricane Evacuation Shelter Selection*, provides information regarding assessing existing buildings for use as hurricane shelters. Unless a school has been specifically designed for use as a safe room or shelter, it should only be used as a last resort and only if the school meets the criteria given in ARC 4496.



Figure 6:33:  
Open walkways do not  
provide protection from  
wind-borne debris.  
Hurricane Katrina  
(Mississippi, 2005).



## 6.3.2 Structural Systems

### 6.3.2.1 Design Parameters for Structural Systems

Based on post-storm damage evaluations, with the exception of canopies and strong and violent tornado events, the structural systems (i.e., MWFRS and structural components such as roof decking) of schools have typically performed quite well during design wind events. There have, however, been notable exceptions; in these cases, the most common problem has been blow-off of the roof deck, but instances of collapse have also been documented (Figures 6-18, 6-21, 6-24, 6-26, and 6-34). The structural problems have primarily been caused by lack of an adequate load path, with connection failure being a common occurrence. Problems have also been caused by reduced structural capacity due to termites, workmanship errors (commonly associated with steel decks attached by puddle welds), and limited uplift resistance of deck connections in roof perimeters and corners (due to lack of code-required enhancement in older editions of the model codes).



**Figure 6-34:** The structure on this school was composed of light gauge metal framing, with a proprietary composite deck system composed of light gauge corrugated metal deck and gypsum board. In addition to the gable end wall failure, the asphalt shingles and underlayment were blown off at the corner of the eave and ridge. Estimated wind speed: 140 to 160 mph. Hurricane Charley (Florida, 2004)

With the exception of strong and violent tornado events, structural systems designed and constructed in accordance with the IBC should typically offer adequate wind resistance, provided attention was given to load path continuity and to the durability of building materials (with respect to corrosion and termites). However, the greatest reliability is offered by cast-in-place concrete. There are no known reports of any cast-in-place concrete buildings experiencing a significant structural problem during wind events, including the strongest hurricanes (Category 5) and tornadoes (EF5).

The following design parameters are recommended for structural systems:

- If a pre-engineered metal building is being contemplated, special steps should be taken to ensure the structure has more redundancy than is typically the case with pre-engineered buildings.<sup>15</sup> Steps should be taken to ensure the structure is not vulnerable to progressive collapse in the event a primary bent (steel moment frame) is compromised or bracing components fail.
- Exterior load-bearing walls of masonry or precast concrete should be designed to have sufficient strength to resist external and internal loading when analyzed as C&C. CMU walls should have vertical and horizontal reinforcing and grout to resist wind loads.

<sup>15</sup> The structural system of pre-engineered metal buildings is composed of rigid steel frames, secondary members (including roof purlins and wall girts made of Z- or C-shaped members), and bracing.

The connections of precast concrete wall panels should be designed to have sufficient strength to resist wind loads.

- For roof decks, concrete, steel, plywood, or oriented strand board (OSB) is recommended.
- For steel roof decks, it is recommended that a screw attachment be specified, rather than puddle welds or powder-driven pins. Screws are more reliable and much less susceptible to workmanship problems, as illustrated by Figure 6-35. These roof joists and decking blew off and landed several feet from the building. The decking was attached with closely-spaced screws. Because of the strength and reliability of the screwed connections, the decking remained attached to the joists.

**Figure 6-35:**  
Even though the roof structure blew off, because of the strength and reliability of the screwed deck connections, the decking remained attached to the joists. Hurricane Charley (Florida, 2004)



Figure 6-36 shows decking that was attached with puddle welds. At most of the welds, there was only superficial bonding of the metal deck to the joist. Only a small portion of the deck near the center of the weld area (as delineated by the circle) was well fused to the joist. Figures 6-37 and 6-38 show problems with acoustical decking attached with powder-driven pins. The pin shown on the left of Figure 6-38 is properly seated. However, the pin at the right did not penetrate far enough into the steel joist below.



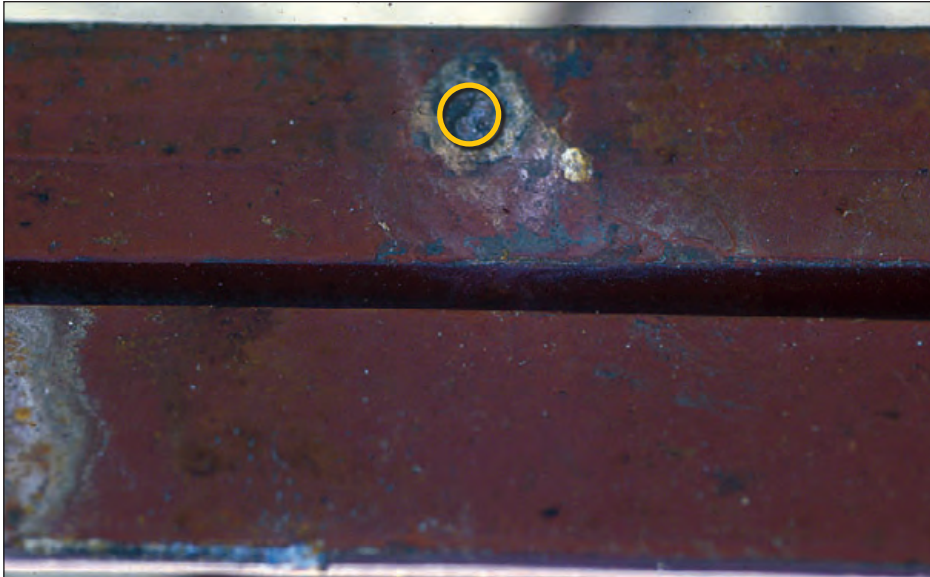

**Figure 6-36:**  
View looking down at the top of a steel joist after the metal decking blew away. Only a small portion of the deck was well fused to the joist (circled area). Tornado (Oklahoma, 1999)



**Figure 6-37:**  
Looking down at a sidelap of a deck attached with powder-driven pins. The washer at the top pin blew through the deck.



**Figure 6-38:**  
View looking along a sidelap of a deck attached with powder-driven pins. The right pin does not provide adequate uplift and shear resistance.

- For attaching wood-sheathed roof decks, screws, ring-shank, or screw-shank nails are recommended in the corner regions of the roof. Where the basic wind speed is greater than 120 mph, these types of fasteners are also recommended for the perimeter regions of the roof.<sup>16</sup>

<sup>16</sup> The 120-mph basic wind speed is based on ASCE 7-10, Risk Category III and IV buildings. If ASCE 7-05 or an earlier version is used, the equivalent wind speed trigger is 90 mph.

- For precast concrete decks it is recommended that the deck connections be designed to resist the design uplift loads because the deck dead load itself is often insufficient to resist the uplift. The deck in Figure 6-39 had bolts to provide uplift resistance; however, anchor plates and nuts had not been installed. Without the anchor plates, the dead load of the deck was insufficient to resist the wind uplift load.
- For precast Tee decks, it is recommended that the reinforcing be designed to accommodate the uplift loads in addition to the gravity loads. Otherwise, large uplift forces can cause member failure due to the Tee's own pre-stress forces after the uplift load exceeds the dead load of the Tee. This type of failure occurred at one of the roof panels shown in Figure 6-40, where a panel lifted because of the combined effects of wind uplift and pre-tension. Also, because the connections between the roof and wall panels provided very little uplift load resistance, several other roof and wall panels collapsed.
- For buildings that have mechanically attached single-ply or modified bitumen membranes, designers should refer to the decking recommendations presented in the *Wind Design Guide for Mechanically Attached Flexible Membrane Roofs*, B1049 (National Research Council of Canada, 2005).

If an FMG-rated roof assembly is specified, the roof deck also needs to comply with the FMG criteria. See text box about FM Global in Section 6.3.3.6.

**Figure 6-39:**  
Portions of this waffled precast concrete roof deck were blown off. Typhoon Paka (Guam, 1997)







**Figure 6-40:**  
Twin-Tee roof panel  
lifted as a result of  
the combined effects  
of wind uplift and  
pre-tension. Tornado  
(Missouri, May 2003)

Walkway and entrance canopies are often damaged during high winds (see Figure 6-41). Wind-borne debris from damaged canopies can damage nearby buildings and injure people; hence, these elements should also receive design and construction attention.



**Figure 6-41:**  
The wind speed was  
sufficient to collapse  
this school's canopy,  
but the speed was not  
high enough to blow  
the canopy debris very  
far. Hurricane Francis  
(Florida, 2004)

ASCE 7-05 provides pressure coefficients for open canopies of various slopes (referred to as “free roofs” in ASCE 7). The free roof figures for MWFRS in ASCE 7-05 (Figures 6-18A to 6-18D) include two load cases, Case A and Case B. While there is no discussion describing the two load cases, they pertain to fluctuating loads and are intended to represent upper and lower limits of instantaneous wind pressures. Loads for both cases must be calculated to determine the critical loads. Figures 6-18A to 6-18C are for a wind direction normal to the ridge. For wind direction parallel to the ridge, use Figure 6-18D in ASCE 7-05.

In ASCE 7-10, Commentary Section C27.4.3 was revised to include discussion of the two load cases. The Commentary was also expanded to include discussion about “clear wind flow” and “obstructed wind flow,” which pertains to storage of goods or materials under the free roof (which restrict wind flow).

### 6.3.2.2 Design Parameters for Structural Systems in Hurricane-Prone Regions

Because of the exceptionally good wind performance and wind-borne debris resistance that reinforced cast-in-place concrete structures offer, a reinforced concrete roof deck and reinforced concrete or reinforced and fully grouted CMU exterior walls are recommended as follows:

**Roof deck:** A minimum 4-inch thick cast-in-place reinforced concrete deck is the preferred deck. Other recommended decks are minimum 4-inch thick structural concrete topping over steel decking, and precast concrete with an additional minimum 4-inch structural concrete topping. With these deck types, deck blow-off or penetration by wind-borne debris is highly unlikely, thus avoiding water infiltration (when combined with the roof system recommendations given in Section 6.3.3.7). Figure 6-42 illustrates the type of damage that can occur to other types of decks impacted by large momentum debris.

If precast concrete is used for the roof or wall structure, the connections should be carefully designed, detailed, and constructed.

**Exterior load-bearing walls:** A minimum 6-inch thick, cast-in-place concrete wall reinforced with #4 rebar at 12 inches on center each way is the preferred wall. Other recommended walls are a minimum 8-inch thick, fully grouted CMU reinforced vertically with #4 rebar at 16 inches on center, and precast concrete that is a minimum 6-inches thick and reinforced equivalent to the recommendations for cast-in-place walls.



**Figure 6-42:**  
At the school shown in Figure 6-34, wind-borne debris ruptured the proprietary composite deck system composed of light gauge corrugated metal deck and gypsum board. Estimated wind speed: 140 to 160 mph. Hurricane Charley (Florida, 2004)

### 6.3.3 Building Envelope

The following section highlights the design considerations for building envelope components that have historically sustained the greatest and most frequent damage in high winds.

The design considerations for building envelope components of schools in hurricane-prone regions include a number of additional recommendations. The principal concern that should be addressed is the additional risk from wind-borne debris and water leakage. Design considerations specific to hurricane-prone regions are discussed in Sections 6.3.3.3, 6.3.3.5, and 6.3.3.7. Design guidance for building envelope components of safe rooms within schools is addressed in Section 6.5.

#### 6.3.3.1 Exterior Doors

This section addresses primary and secondary egress doors, sectional (garage) doors, and rolling doors. Although blow-off of personnel doors is uncommon, it can cause serious problems. Blown-off doors allow entrance of rain and tumbling doors can damage buildings and cause injuries.



For further general information on doors, see “Fenestration Systems” in the National Institute of Building Sciences’ Building Envelope Design Guide ([www.wbdg.org/design/envelope.php](http://www.wbdg.org/design/envelope.php)).

Although many schools do not have sectional or rolling doors, blow-off of these types of doors is quite common. These failures are typically caused by the use of door and track assemblies that have insufficient wind resistance, or by inadequate attachment of the tracks or nailers to the wall.

### Loads and Resistance

The IBC requires that the door assembly (i.e., door, hardware, frame, and frame attachment to the wall) be of sufficient strength to resist the positive and negative design wind pressure. Design professionals should require that doors comply with wind load testing in accordance with ASTM E 1233. Design professionals should also specify the attachment of the door frame to the wall (e.g., type, size, spacing, and edge distance of frame fasteners). For sectional and rolling doors attached to wood nailers, design professionals should also specify the attachment of the nailer to the wall.

For design guidance on attachment of door frames, see Technical Data Sheet #161, *Connecting Garage Door Jambs to Building Framing*, published by the Door & Access Systems Manufacturers Association, 2003 (revised May 2008). Available at [www.dasma.com](http://www.dasma.com).

### Water Infiltration

Heavy rain that accompanies high winds (e.g., thunderstorms, tropical storms, and hurricanes) can cause significant wind-driven water infiltration problems. The magnitude of the problem increases with the wind speed. Leakage can occur between the door and its frame, the frame and the wall, and between the threshold and the door. When wind speeds approach 165 mph, some leakage should be anticipated because of the very high wind pressures and numerous opportunities for leakage path development.<sup>17</sup>

The following recommendations should be considered to minimize infiltration around exterior doors.

**Vestibule:** Adding a vestibule allows both the inner and outer doors to be equipped with weatherstripping. The vestibule can be designed with water-resistant finishes (e.g., concrete or tile) and the floor can be equipped with a drain. In addition, installing exterior threshold trench drains can be helpful (openings must be small enough to avoid trapping high-heeled shoes). Note that trench drains do not eliminate the problem, since water can still penetrate at door edges.

Where corrosion is problematic, anodized aluminum or galvanized doors and frames, and stainless steel frame anchors and hardware are recommended.

<sup>17</sup> The 165-mph basic wind speed is based on ASCE 7-10, Risk Category III and IV buildings. If ASCE 7-05 or an earlier version is used, the equivalent wind speed trigger is 120 mph.

**Door swing:** Out-swinging doors have weatherstripping on the interior side of the door, where it is less susceptible to degradation, which is an advantage when compared to in-swinging doors. Some interlocking weatherstripping assemblies are available for out-swinging doors.

The successful integration of the door frame and the wall is a special challenge when designing doors. See Section 6.3.3.2 for discussion of this juncture.

ASTM E 2112 provides information pertaining to the installation of doors, including the use of sill pan flashings with end dams and rear legs (see Figure 6-43). It is recommended that designers use ASTM E 2112 as a design resource.

**Weatherstripping**

A variety of pre-manufactured weatherstripping components is available, including drips, door shoes and bottoms, thresholds, and jamb/head weatherstripping.

**Drips:** These are intended to shed water away from the opening between the frame and the door head, and the opening between the door bottom and the threshold (see Figures 6-44 and 6-45). Alternatively, a door sweep can be specified (see Figure 6-45). For high-traffic doors, periodic replacement of the neoprene components will be necessary.

For primary swinging entry/exit doors, exit door hardware is recommended to minimize the possibility of the doors being pulled open by wind suction. Exit hardware with top and bottom rods is more secure than exit hardware that latches at the jamb.

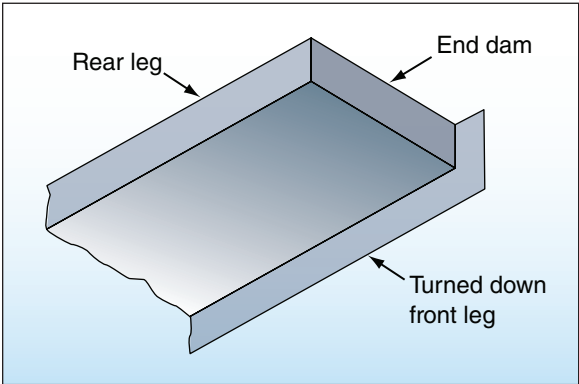

**Figure 6-43:** Door sill pan flashing with end dams, rear leg, and turned-down front leg

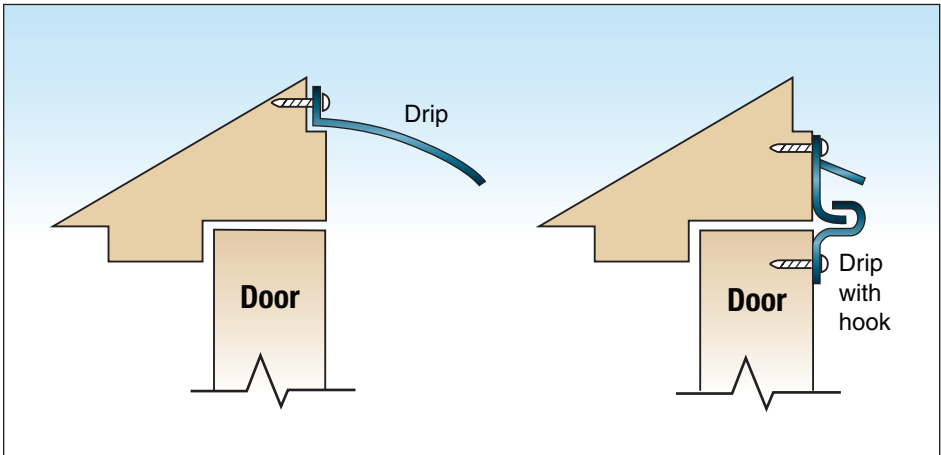

**Figure 6-44:** Drip at door head and drip with hook at head



Figure 6-45:  
Door shoe with drip  
and vinyl seal (left);  
neoprene door sweep  
(right)

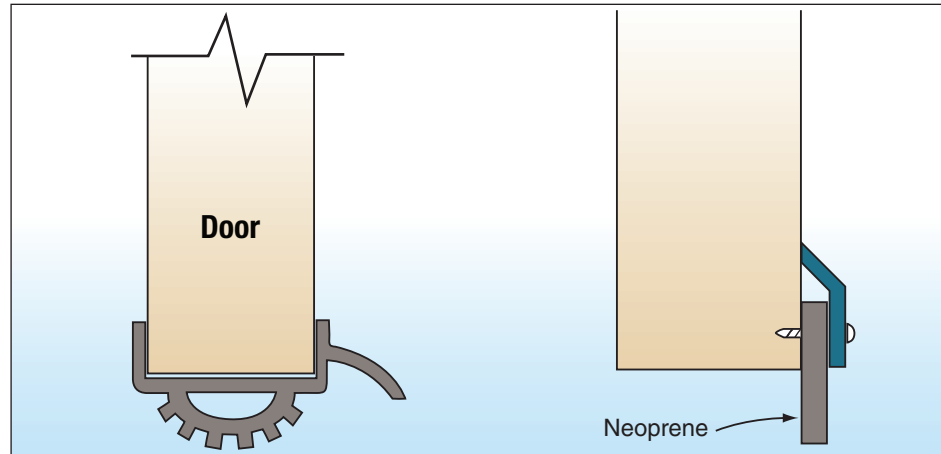
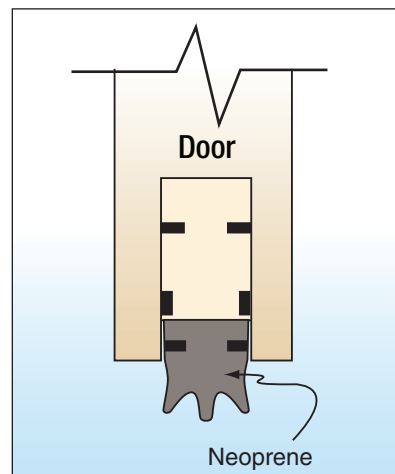

Figure 6-46:  
Automatic door bottom



**Door shoes and bottoms:** These are intended to minimize the gap between the door and the threshold. Figure 6-45 illustrates a door shoe that incorporates a drip. Figure 6-46 illustrates an automatic door bottom. Door bottoms can be surface-mounted or mortised. For high-traffic doors, periodic replacement of the vinyl or neoprene components will be necessary.

**Thresholds:** These are available to suit a variety of conditions. Thresholds with high (e.g., 1-inch) vertical offsets offer enhanced resistance to wind-driven water infiltration. However, the offset is limited where the thresholds are required to comply with the Americans with Disabilities Act (ADA), or at high-traffic doors. At other doors, high offsets are preferred.

Thresholds can be interlocked with the door (see Figure 6-47), or thresholds can have a stop and seal (see Figure 6-48). In some instances, the threshold is set directly on the floor. Where this is appropriate, setting the threshold in butyl sealant is recommended to avoid water infiltration between the threshold and the floor. In other instances, the threshold is set on a pan flashing (as previously discussed in this section). If the threshold has weep holes, specify that the weep holes not be obstructed during construction (see Figure 6-47).

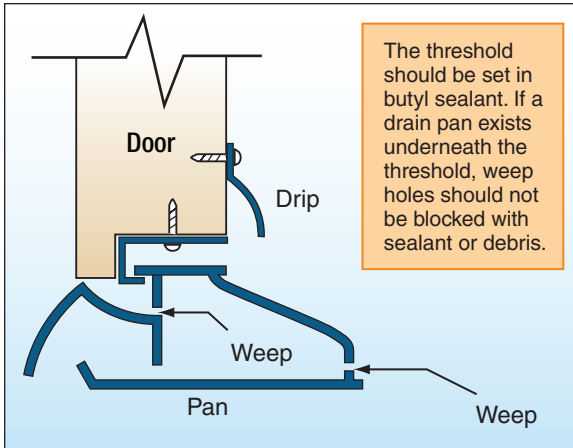

**Figure 6-47:**  
Interlocking threshold with drain pan

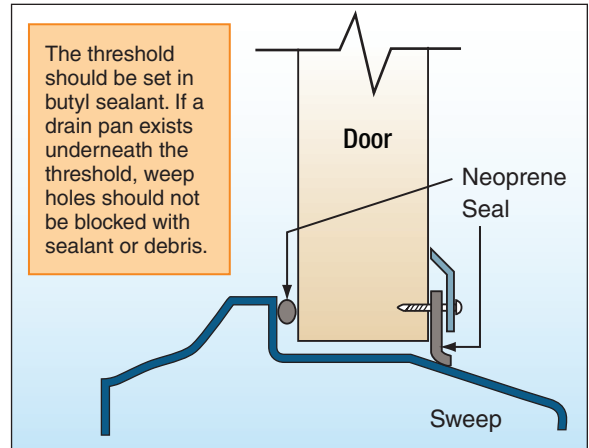

**Figure 6-48:**  
Threshold with stop and seal

**Adjustable jamb/head weatherstripping:** This type of weatherstripping is recommended because the wide sponge neoprene offers good contact with the door (see Figure 6-49). The adjustment feature also helps to ensure good contact, provided the proper adjustment is maintained.

**Meeting stile:** At the meeting stile of pairs of doors, an overlapping astragal weatherstripping offers greater protection than weatherstripping that does not overlap.

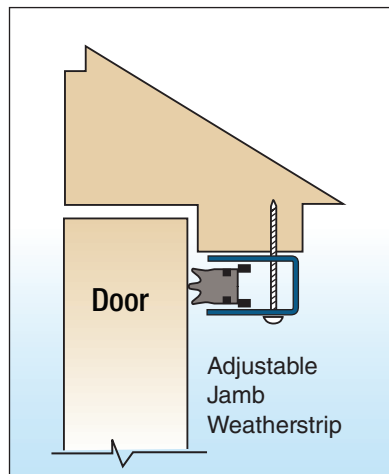

**Figure 6-49:**  
Adjustable jamb/head weatherstripping

### 6.3.3.2 Windows and Skylights

This section addresses general design considerations for exterior windows and skylights. For additional information on windows and skylights located in hurricane-prone regions, see Section 6.3.3.3.

#### Loads and Resistance

The IBC requires that windows, curtain walls, and skylight assemblies (i.e., the glazing, frame, and frame attachment to the wall or roof) have sufficient strength to resist the positive and negative design wind pressure (see Figure 6-50). Design professionals should specify that these assemblies

For further general information on windows, see the National Institute of Building Sciences' *Building Envelope Design Guide* ([www.wbdg.org/design/envelope.php](http://www.wbdg.org/design/envelope.php)).

comply with wind load testing in accordance with ASTM E 1233. It is important to specify an adequate load path and to check its continuity during submittal review.

Where water infiltration protection is particularly demanding and important, it is recommended that on-site water infiltration testing in accordance with ASTM E 1105, be specified.

**Figure 6-50:**  
Two complete windows, including frames, blew out as a result of an inadequate number of fasteners. Typhoon Paka (Guam, 1997)



### Water Infiltration

Heavy rain accompanied by high winds can cause wind-driven water infiltration problems. The magnitude of the problem increases with the wind speed. Leakage can occur at the glazing/frame interface, the frame itself, or between the frame and wall. When the basic wind speed is greater than 165 mph, because of the very high design wind pressures and numerous opportunities for leakage path development, some leakage should be anticipated when the design wind speed conditions are approached.<sup>18</sup>

Where corrosion is problematic, anodized aluminum or galvanized window frames, and stainless steel frame anchors and hardware are recommended.

The successful integration of windows and curtain walls into exterior walls is a challenge in protecting against water infiltration. To the extent possible, when detailing the interface between the wall and the window or curtain wall units, designers should

rely on sealants as the secondary line of defense against water infiltration, rather than making the sealant the primary protection. If a sealant

<sup>18</sup> The 165-mph basic wind speed is based on ASCE 7-10, Risk Category III and IV buildings. If ASCE 7-05 or an earlier version is used, the equivalent wind speed trigger is 120 mph.

joint is the first line of defense, a second line of defense should be designed to intercept and drain water that drives past the sealant joint.

When designing joints between walls and windows and curtain wall units, consider the shape of the sealant joint (i.e., a square joint is typically preferred) and the type of sealant to be specified. The sealant joint should be designed to enable the sealant to bond on only two opposing surfaces (i.e., a backer rod or bond-breaker tape should be specified). Butyl is recommended as a sealant for concealed joints, and polyurethane for exposed joints. During installation, cleanliness of the sealant substrate is important (particularly if polyurethane or silicone sealants are specified), as is the tooling of the sealant. ASTM E 2112 provides guidance on the design of sealant joints, as well as other information pertaining to the installation of windows, including the use of sill pan flashings with end dams and rear legs (see Figure 6-51). Windows that do not have nailing flanges should typically be installed over a pan flashing. It is recommended that designers use ASTM E 2112 as a design resource.

Sealant joints can be protected with a removable stop, as illustrated in Figure 6-52. The stop protects the sealant from direct exposure to the weather and reduces the possibility of wind-driven rain penetration.

The maximum test pressure used in the current ASTM test standard for evaluating resistance of window units to wind-driven rain is well below design wind pressures. Therefore, units that demonstrate adequate wind-driven rain resistance during testing may experience leakage during actual wind events.

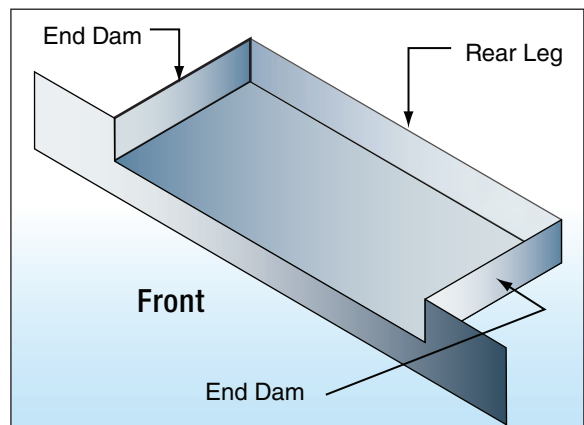

**Figure 6-51:** View of a typical window sill pan flashing with end dams, rear leg, and turned-down front leg.

SOURCE: ASTM E 2112

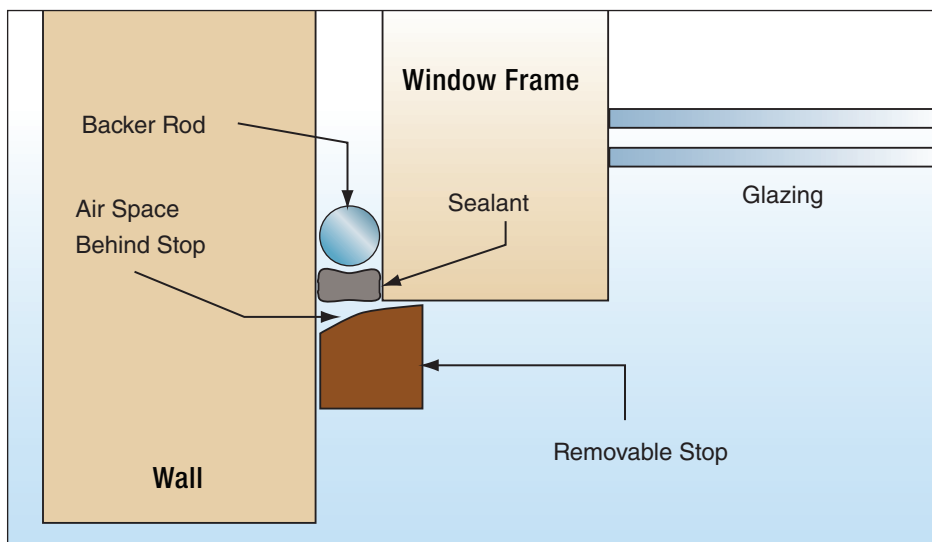

**Figure 6-52:** Protecting sealant retards weathering and reduces the exposure to wind-driven rain

### 6.3.3.3 Windows and Skylights in Hurricane-Prone Regions

Exterior glazing that is not impact-resistant (such as laminated glass or polycarbonate) or protected by shutters is extremely susceptible to breaking if struck by wind-borne debris. Even small, low-momentum missiles can easily break glazing that is not protected. At the building shown in Figure 6-53, approximately 400 windows were broken. Most of the breakage was caused by wind-blown aggregate from the building's aggregate-ballasted single-ply membrane roofs, and aggregate from built-up roofs. With broken windows, a substantial amount of water can be blown into a building, and the internal air pressure can be greatly increased, which may damage the interior partitions and ceilings.

**Figure 6-53:** Plywood panels (black continuous bands) installed after the glass spandrel panels were broken by roof aggregate.<sup>19</sup> Estimated wind speed: 130 mph. Hurricane Katrina (Mississippi, 2005)



In order to minimize interior damage, the IBC, through ASCE 7, prescribes that exterior glazing in wind-borne debris regions be impact-resistant, or be protected with an impact-resistant covering (shutters). ASCE 7 refers to ASTM E 1996 for missile loads and to ASTM E 1886 for the test method to be used to demonstrate compliance with the E 1996 load criteria. In addition to testing impact resistance, the window unit is subjected to pressure cycling after test missile impact to evaluate whether the window can still resist wind loads. If wind-borne debris glazing protection is provided by shutters,

Protection of glazing for safe rooms must meet debris impact criteria that is more restrictive (significant) than that presented in the building codes and the ICC 500. See Chapter 3 of FEMA 361 for the design criteria for debris impact resistance for safe rooms.

<sup>19</sup> Glass spandrel panels are opaque glass. They are placed in curtain walls to conceal the area between the ceiling and the floor above.



the glazing is still required by ASCE 7 to meet the positive and negative design air pressures.

For Category III and IV buildings in areas with a basic wind speed of 130 mph or greater, the glazing or shutter is required to resist a larger momentum test missile than would Category II, III, and IV buildings in areas with basic wind speeds less than 130 mph. (Note: The 2009 edition of ASTM E 1996 references 130 mph based on ASCE 7-05. When using ASCE 7-10, a basic wind speed of 175 mph applies for Risk Category III and IV buildings).

Although the ASCE 7 wind-borne debris provisions only apply to glazing within a portion of hurricane-prone regions, it is recommended that all schools located where the basic wind speed is 135 mph or greater comply with the following recommendation:<sup>20</sup>

- To avoid interior wind and water damage, it is recommended that exterior glazing be designed to resist the test Missile D load (unless the E test missile is required as previously discussed) specified in ASTM E 1996 (see text box on the following page).

Window assemblies with laminated glass that have passed ASTM E 1886 can also be easily broken by low-momentum debris. However, unlike other types of glass, when laminated glass breaks, it is expected to remain in the frame and prevent entrance of wind and water. Cost will be incurred to replace the broken laminated glass, but that cost is significantly less than the cost of repairing interior wind and water damage, and the costs associated with loss of use of the school during repair work. Figure 6-54 shows laminated glass that was broken, but protected the building's interior as intended.



**Figure 6-54:** The red arrow shows a piece of laminated glass that was broken, but remained in the frame to protect the building's interior. The blue arrow shows unbroken laminated glass. The yellow arrows show granite wall panels. Estimated wind speed: 105 mph. Hurricane Katrina (Louisiana, 2005)

<sup>20</sup> The 135-mph basic wind speed is based on ASCE 7-10, Risk Category III and IV buildings. If ASCE 7-05 or an earlier version is used, the equivalent wind speed trigger is 100 mph.

ASTM E 1996 specifies five missile categories, A through E. The missiles are of various weights and fired at various velocities during testing. Building type (critical or non-critical) and basic wind speed determine the missiles required for testing. Of the five missiles, the E missile has the greatest momentum. Missile E is required for critical facilities located where the basic wind speed is greater than or equal to 130 mph. Missile D is permitted where the basic wind speed is less than 130 mph. FEMA 361 also specifies a missile for shelters. The shelter missile has much greater momentum than the D and E missiles, as shown below:

Missile	Missile Weight	Impact Speed	Momentum
ASTM E 1996—D	9 pound 2x4 lumber	50 feet per second (34 mph)	14 lb <sub>f</sub> -s*
ASTM E 1996—E	9 pound 2x4 lumber	80 feet per second (55 mph)	22 lb <sub>f</sub> -s*
FEMA 361 (Shelter Missile)	15 pound 2x4 lumber	147 feet per second (100 mph)	68 lb <sub>f</sub> -s*

\*lb<sub>f</sub>-s = POUNDS FORCE PER SECOND

- For those facilities where glazing resistant to bomb blasts is desired, the windows and glazed doors can be designed to accommodate wind pressure, missile loads, and blast pressure. However, the window and door units need to be tested for missile loads and cyclic air pressure, as well as for blast. A unit that meets blast criteria will not necessarily meet the ASTM E 1996 and ASTM E 1886 criteria, and vice versa.

For further information on designing glazing to resist blast, see the “Blast Safety” resource pages of the National Institute of Building Sciences’ *Building Envelope Design Guide* ([www.wbdg.org/design/envelope.php](http://www.wbdg.org/design/envelope.php)).

With the advent of building codes requiring glazing protection in wind-borne debris regions, a variety of shutter designs have entered the market. Shutters typically have a lower initial cost than laminated glass. However, unless the shutter is permanently anchored to the building (e.g., an accordion shutter), storage space will be needed. Also, when a hurricane is forecast, costs will be incurred each time shutters are installed and removed. The cost

and difficulty of shutter deployment and demobilization on upper-level glazing may be avoided by using motorized shutters, although laminated glass may be a more economical solution. For further information on shutters, see Section 6.4.2.1.

For further general information on non-load-bearing walls and wall coverings, see the National Institute of Building Sciences’ *Building Envelope Design Guide* ([www.wbdg.org/design/envelope.php](http://www.wbdg.org/design/envelope.php)).

#### 6.3.3.4 Non-Load-Bearing Walls, Wall Coverings, and Soffits

This section addresses exterior non-load-bearing walls, exterior wall coverings, and soffits, as well as the underside of elevated floors, and provides guidance for interior non-load-bearing masonry

walls. See Section 6.4.3.5 for additional information pertaining to non-load-bearing walls, exterior wall coverings, and soffits for schools located in hurricane-prone regions.

### Loads and Resistance

The IBC requires that soffits, exterior non-load-bearing walls, and wall coverings have sufficient strength to resist the positive and negative design wind pressures.

**Soffits:** Depending on the wind direction, soffits can experience either positive or negative pressure.

Besides the cost of repairing the damaged soffits, wind-borne soffit debris can cause property damage and injuries. Failed soffits may also provide a convenient path for wind-driven rain to enter the building, as illustrated by Figure 6-55. This school had a steep-slope roof with a ventilated attic space. The exterior CMU/brick veneer wall stopped just above the soffit (red arrows at Figure 6-55). Wind-driven rain entered the attic space where the soffit had blown away. This and other storm-damage research has shown that water blown into attic spaces after the loss of soffits can cause significant damage and the collapse of ceilings. Even in instances where soffits remain in place, water can penetrate through soffit vents and cause damage.

Where corrosion is a problem, stainless steel fasteners are recommended for wall and soffit systems. For other components (e.g., furring, blocking, struts, and hangers), nonferrous components (such as wood), stainless steel, or steel with a minimum of G-90 hot-dipped galvanized coating are recommended. Additionally, access panels are recommended so components within soffit cavities can be periodically inspected for corrosion or dry rot.



Figure 6-55:

The exterior wall stopped just above the soffit (red arrows). After the metal soffit panels blew away, wind-driven rain blew into the attic space, which saturated the fiberglass batt insulation and caused the ceiling boards to collapse. Estimated wind speed: 130 mph. Hurricane Katrina (Mississippi, 2005)



For soffit design and application recommendations, see FEMA P-499, Fact Sheet 7.5, *Minimizing Water Intrusion Through Roof Vents in High-Wind Regions*, (2010), available at <http://www.fema.gov/library/viewRecord.do?id=2138>.

The 2010 edition of ASCE 7 added loading criteria for soffits. Section 30.9.3 states that pressures on soffits (referred to as “overhangs”) are equal to the adjacent wall pressures. At this time, the only known test standard pertaining to soffit wind and wind-driven rain resistance is the Florida Building Code’s *Testing Application Standard (TAS) No. 100(A)-95*. With this method, wind pressure testing is

conducted to a maximum test speed of 140 mph, and wind-driven rain testing is conducted to a maximum test speed of 110 mph. The results of laboratory research have shown the need to develop an improved test method to evaluate the wind pressure and wind-driven rain resistance of soffits, but an improved test method has not yet been standardized.

**Exterior non-load-bearing masonry walls:** Particular care should be given to the design and construction of exterior non-load-bearing masonry walls. Although these walls are not intended to carry gravity loads, they should be designed to resist the external and internal loading for components and cladding in order to avoid collapse.

When these types of walls collapse, they represent a severe risk to life because of their great weight.

**Interior non-load-bearing masonry walls:** Special consideration should also be given to interior non-load-bearing masonry walls. Although these walls are not required by building codes to be designed to resist wind loads, if the exterior glazing is broken, or the exterior doors are blown away, the interior walls could be subjected to significant loads as the building rapidly becomes fully pressurized. To avoid casualties, it is recommended that interior non-load-bearing masonry walls adjacent to occupied areas be designed to accommodate loads exerted by a design wind event, using the partially enclosed pressure coefficient (see Figure 6-56). By doing so, wall collapse may be prevented if the building envelope is breached. This recommendation is applicable to schools that will be used as hurricane evacuation shelters, to schools located in areas with a basic wind speed greater than 165 mph,<sup>21</sup> and to schools in tornado-prone regions that do not have shelter space designed in accordance with FEMA 361.



**Figure 6-56:** The red arrows show the original location of a CMU wall that nearly collapsed following a rolling door failure. Estimated wind speed: 140–160 mph. Hurricane Charley (Florida, 2004)

<sup>21</sup> The 165-mph basic wind speed is based on ASCE 7-10, Risk Category III and IV buildings. If ASCE 7-05 or an earlier version is used, the equivalent wind speed trigger is 120 mph.

## Wall Coverings

There are a variety of exterior wall coverings. Brick veneer, exterior insulation finish systems (EIFS), stucco, metal wall panels, and aluminum and vinyl siding have often exhibited poor wind performance. Veneers (such as ceramic tile and stucco) over concrete, stone veneer, and cement-fiber panels and siding have also blown off. Wood siding and panels rarely blow off. Although tilt-up precast walls have failed during wind storms, precast wall panels attached to steel or concrete framed buildings typically offer excellent wind performance. The elevated school shown in Figure 6-57 had precast wall panels. The panels performed well, but portions of the roof covering blew off. Rooftop equipment also blew off. A gas line to one of the rooftop units was ruptured and displaced.

Most schools do not have elevator penthouses. But for those that do, the penthouse walls must possess adequate wind and water resistance in order to ensure continuity of elevator service. If the walls blow away or water leaks through the wall system, the elevator controls and/or motors can be destroyed. Loss of elevators may affect facility operations. The restoration of elevator service can take weeks, even with expedited work.



**Figure 6-57:** Although uncommon for schools, precast wall panels were attached to the structural frame of this school. This type of wall typically offers excellent wind performance. Note the roof covering damage and displaced gas line. Estimated wind speed: Approximately 125–130 mph. Hurricane Katrina (Louisiana, 2005)

**Brick veneer:** Brick veneer is frequently blown off walls during high winds. When brick veneer fails, wind-driven water can enter and damage buildings, and building occupants can be vulnerable to injury from wind-borne debris (particularly if the walls are sheathed with plastic foam insulation or wood fiberboard in lieu of wood panels). Pedestrians in the vicinity of damaged walls can also be vulnerable to injury from falling veneer. Common failure modes include tie (anchor) fastener pull-out, failure of masons to embed ties into the mortar (Figure 6-58), poor bonding between ties and mortar, a mortar of poor quality, and tie corrosion.



**Figure 6-58:**  
The four ties shown by the red arrows were not embedded into the mortar. Estimated wind speed: 105 mph. Hurricane Katrina, (Mississippi, 2005)



For brick veneer design and application recommendations, see FEMA P-499, Fact Sheet 5.4, *Attachment of Brick Veneer in High-Wind Regions*, (2010), available at <http://www.fema.gov/library/viewRecord.do?id=2138>.

Ties are often installed before brick laying begins. When this is done, ties are often improperly placed above or below the mortar joints. When misaligned, the ties must be angled up or down to be embedded into the mortar joints. Misalignment not only reduces the embedment depth, but also reduces the effectiveness of the ties, because wind forces do not act parallel to the ties themselves.

Corrugated ties typically used in residential veneer construction provide little resistance to compressive loads. The use of compression struts would likely be beneficial, but off-the-shelf devices do not currently exist. Two-piece adjustable ties provide significantly greater compressive strength than corrugated ties, and are therefore recommended.

To avoid water leaking into the building, it is important that weep holes be adequately spaced and not be blocked during brick installation, and that through-wall flashings be properly designed and installed. When the base of the brick veneer occurs near grade, the grade should be designed so that it occurs several inches below the weeps so that drainage from the weeps is not impeded. Also, landscaping should be kept clear of weeps so that vegetation growth does not cause blockage of weeps. At the building shown in Figure 6-59, water leaked into the building along the base of many of the brick veneer walls. When high winds accompany heavy rain, a substantial amount of water can be blown into the wall cavity.

**EIFS:** Figure 6-60 shows typical EIFS assemblies. Figure 6-61 shows EIFS blow-off. In this case, the molded expanded polystyrene (MEPS) was attached to gypsum board, which in turn was attached to metal studs. The gypsum board detached from the studs, which is a common EIFS failure mode. When the gypsum board on the exterior side of the studs is blown away, it is common for gypsum board on the interior side to also be blown off. The opening allows the building to become fully pressurized and allows the entrance of wind-driven rain. Other common types of failure include wall framing failure (see Figure 6-63), separation of the MEPS from its substrate, and separation of the synthetic stucco from the MEPS.

When EIFS is applied over a concrete or CMU wall, the concrete/CMU substrate normally prevents wind and water from entering a building. But if the EIFS debonds from the concrete/CMU, EIFS debris can break unprotected glazing.



**Figure 6-59:** Water leaked inside along the base of the brick veneer walls (red arrow). Estimated wind speed: 115 mph. Hurricane Katrina (Louisiana, 2005)

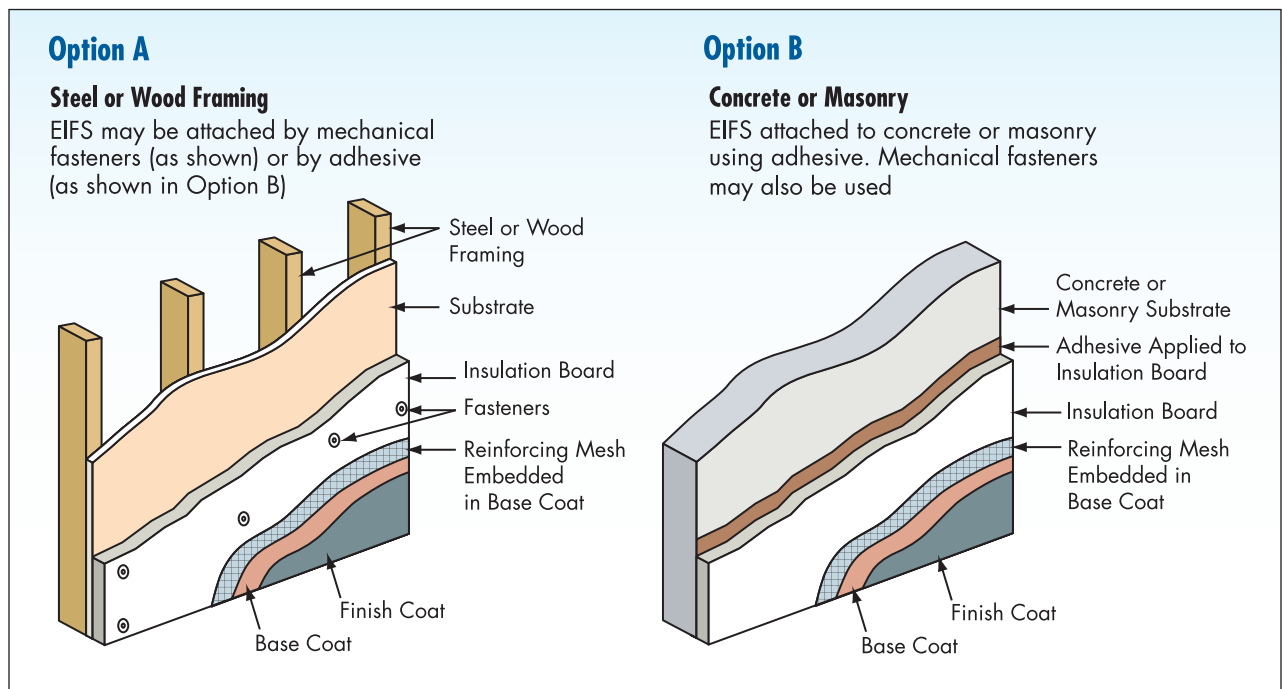

**Figure 6-60:** Typical EIFS assemblies

**Figure 6-61:**  
EIFS blow-off near a wall corner. At one area, the metal fascia was also blown in.

SOURCE: FEMA 342, OKLAHOMA AND KANSAS MIDWEST TORNADOES OF MAY 3, 1999 (1999B)



Reliable wind performance of EIFS is very demanding on the designer and installer. It is particularly important to attach the gypsum board with a sufficient number of properly located fasteners and to properly apply the adhesive. At the newly constructed building shown in Figure 6-62, several of the gypsum boards blew off because of an inadequate number of screws. Also, at the gypsum board joint, there was insufficient fastener edge distance. Although not the primary failure mode, the adhesive between the MEPS and gypsum board was applied in rows, rather than continuously over the entire substrate with a notched trowel.

**Figure 6-62:**

At this EIFS failure, the screws attaching the gypsum board (yellow colored material) were too far apart (red circle). Additionally, at the board joint, the screws were too close to the board edge (blue circle). In this area, the screws were spaced at  $4\frac{1}{2}$ , 4, 6, 6, 9, and  $9\frac{1}{2}$  inches on center. Also, the adhesive between the gypsum board and MEPS was applied in rows rather than continuously over the gypsum board. Estimated wind speed: 120 mph. Hurricane Katrina (Mississippi, 2005)



Maintenance of EIFS and associated sealant joints in order to minimize the reduction of EIFS' wind resistance due to water infiltration is also important. It is strongly recommended that EIFS be designed with a drainage system that allows for the dissipation of water leaks. For further information on EIFS performance during high winds and design guidance, see FEMA 489 and 549.

Another issue associated with EIFS is the potential for judgment errors. EIFS applied over studs is sometimes mistaken for a concrete wall, which people may seek shelter behind. However, instead of being protected by several inches of concrete, only two layers of gypsum board (i.e., one layer on each side of the studs) and a layer of MEPS separate the occupants from the impact of wind-borne debris that can easily penetrate such a wall and cause injury.

**Stucco over studs:** Wind performance of traditional stucco walls is similar to the performance of EIFS, as shown in Figure 6-63. In several areas the metal stud system failed, in other areas the gypsum sheathing blew off the studs, and in other areas, the metal lath blew off the gypsum sheathing. The failure shown in Figure 6-63 illustrates the importance of designing and constructing wall framing (including attachment of stud tracks to the building and attachment of the studs to the tracks) to resist the design wind loads.



**Figure 6-63:** The stucco wall failure was caused by inadequate attachment between the stud tracks and the building's structure. All of the metal stud framing within the red oval blew away. The arrow shows a bottom stud track that detached and pulled away from the building. Estimated wind speed: 110–125 mph. Hurricane Ivan (Florida, 2004)

**Metal wall panels:** Wind performance of metal wall panels is highly variable. Performance depends on the strength of the specified panel (which is a function of material and thickness, panel profile, panel width, and whether the panel is a composite) and the adequacy of the attachment (which can be by either concealed clips or exposed fasteners). Excessive spacing between clips/fasteners is the most common problem. Clip/fastener spacing should be specified, along with the specific type and size of fastener. Figure 6-64 illustrates metal wall panel problems. At this school (which is also shown in Figure 6-12), the metal panels were attached with concealed fasteners. The panels unlatched at the standing seams. In addition to generating wind-borne debris, loss of panels allowed wind-driven rain to enter the building. Water entry was facilitated by lack of a moisture barrier and solid sheathing behind the metal panels (as discussed below).

**Figure 6-64:**  
The loss of metal wall panels allowed a substantial amount of wind-driven rain to penetrate into the classroom. Estimated wind speed: 105–115 mph. Hurricane Ivan (Florida, 2004)



Metal wall panel performance also depends on adequacy of the framing to which it is attached. At the school shown in Figure 6-65, the metal fascia panels were attached to wood furring that was inadequately attached to CMU. Unlike the condition at the school shown at Figure 6-64, with the CMU behind the metal panels, water was prevented from entering the school. However, wind-borne fascia debris can cause damage or cause injury.





**Figure 6-65:**  
Blow-off of metal fascia panels due to inadequate attachment of wood furring to the CMU wall. Estimated wind speed: 85–95 mph. Hurricane Ivan (Florida, 2004)

To minimize water infiltration at metal wall panel joints, it is recommended that sealant tape be specified at sidelaps when the basic wind speed is in excess of 120 mph.<sup>22</sup> However, endlaps should be left unsealed so that moisture behind the panels can be wicked away. endlaps should be a minimum of 3 inches (4 inches where the basic wind speed is greater than 165 mph<sup>23</sup>) to avoid wind-driven rain infiltration. At the base of the wall, a 3-inch (4-inch) flashing should also be detailed, or the panels should be detailed to overlap with the slab or other components by a minimum of 3 inches (4 inches).

**Siding:** Vinyl siding blow-off is typically caused by nails spaced too far apart and/or the use of vinyl siding that has inadequate wind resistance. Vinyl siding is available with enhanced wind resistance features, such as an enhanced nailing hem, greater interlocking area, and greater thickness. In high wind regions, fiber cement siding blow-off is typically caused by the use of blind nails rather than face nails (see Figure 6-66). Where the design wind speed is low enough to use blind nailing, if blow-off occurs, it is typically caused by nails spaced too far apart and/or too close to the edge of the siding. Wood siding generally performs well in high wind events.

<sup>22</sup> The 120-mph basic wind speed is based on ASCE 7-10, Risk Category III and IV buildings. If ASCE 7-05 or an earlier version is used, the equivalent wind speed trigger is 90 mph.

<sup>23</sup> The 165-mph basic wind speed is based on ASCE 7-10, Risk Category III and IV buildings. If ASCE 7-05 or an earlier version is used, the equivalent wind speed trigger is 120 mph.



**Figure 6-66:**

This cement fiber siding was attached with blind nails (red circle). Because of the high design wind speed, face nails should have been used (blue circle). Hurricane Francis (Florida, 2004)

**Secondary line of protection:** Almost all wall coverings permit the passage of some water past the exterior surface of the covering, particularly when the rain is wind-driven. For this reason, most wall coverings should be considered water-shedding, rather than waterproofing coverings. To avoid moisture-related problems, it is recommended that a

secondary line of protection with a moisture barrier (such as housewrap or asphalt-saturated felt) and flashings around door and window openings be provided. Designers should specify that horizontal laps of the moisture barrier be installed so that water is allowed to drain from the wall (i.e., the top sheet should lap over the bottom sheet so that water running down the sheets remains on their outer surface). The bottom of the moisture barrier needs to be designed to allow drainage. Had the

metal wall panels shown in Figure 6-64 been applied over a moisture barrier and sheathing, the amount of water entering the school would have likely been eliminated or greatly reduced, as is the case with the school shown in Figure 6-65.

For siding design and application recommendations, see FEMA P-499, Fact Sheet 5.3, *Siding Installation in High-Wind Regions*, (2010), available at <http://www.fema.gov/library/viewRecord.do?id=2138>.

In areas that experience frequent wind-driven rain, incorporating a pressure-equalized rain screen design, by installing vertical furring strips between the moisture barrier and siding materials, will facilitate drainage of water from the space between the moisture barrier and backside of the siding. (For further information on rain screen wall systems, see the Siding Advisory.) In areas that frequently experience strong winds, enhanced flashing is recommended. Enhancements include use of flashings that have extra-long flanges, and the use of sealant and tapes. Flashing design should recognize that wind-driven water could be pushed up vertically. The height to which water can be pushed increases with wind speed. Water can also migrate vertically and horizontally by capillary action between layers of materials (e.g., between a flashing flange and housewrap). Use of a rain screen design, in conjunction with enhanced flashing design, is recommended in areas that frequently experience wind-driven rain or strong winds. It is recommended that designers attempt to determine what type of flashing details have successfully been used in the area where the facility will be constructed.

#### Underside of Elevated Floors

- If sheathing is applied to the underside of joists or trusses elevated on piles (e.g., to protect insulation installed between the joists/trusses), its attachment should be specified in order to avoid blow-off. Stainless steel or hot-dip galvanized nails or screws are recommended. Since ASCE 7 does not provide guidance for load determination, professional judgment in specifying attachment is needed.

#### 6.3.3.5 Non-Load-Bearing Walls, Wall Coverings, and Soffits in Hurricane-Prone Regions

To minimize long-term problems with exterior wall coverings and soffits, it is recommended that they be avoided to the maximum extent possible. Exposed or painted reinforced concrete or CMU offers greater reliability (i.e., they have no coverings that can blow off and become wind-borne debris).

For interior non-load-bearing masonry walls in schools located where the basic wind speed is greater than 165 mph, see the recommendations given in Section 6.3.3.4.<sup>24</sup>

---

<sup>24</sup> The 165-mph basic wind speed is based on ASCE 7-10, Risk Category III and IV buildings. If ASCE 7-05 or an earlier version is used, the equivalent wind speed trigger is 120 mph

### 6.3.3.6 Roof Systems

For further general information on roof systems, see the National Institute of Building Sciences' *Building Envelope Design Guide* ([www.wbdg.org/design/envelope.php](http://www.wbdg.org/design/envelope.php)).

Because roof covering damage has historically been the most frequent and the costliest type of wind damage, special attention needs to be given to roof system design. See Section 6.3.3.7 for additional information pertaining to schools located in hurricane-prone regions.

#### Code Requirements

The IBC requires the load resistance of the roof assembly to be evaluated by one of the test methods listed in IBC's Chapter 15. Design professionals are cautioned that designs that deviate from the tested assembly (either with material substitutions or change in thickness or arrangement) may adversely affect the wind performance of the assembly. The IBC does not specify a minimum safety factor. However, for the roof system, a safety factor of 2 is recommended. To apply the safety factor, divide the test load by 2 to determine the allowable design load. Conversely, multiply the design load by 2 to determine the minimum required test resistance.

The roof of the elevator penthouse must possess adequate wind and water resistance to ensure continuity of elevator service. It is recommended that a secondary roof membrane, as discussed in Section 6.3.3.7, be specified over the elevator penthouse roof deck.

The Design Load when using allowable stress design:

When using ASCE 7-05 and earlier editions, the design load is the load derived from the calculation procedure given in Chapter 6.

When using ASCE 7-10, the design load is the load derived from the calculation procedure given in Chapter 30, which is then multiplied by 0.6 (the load combination factor given in Section 2.4.1).

For structural metal panel systems, the IBC requires test methods UL 580 or ASTM E 1592. It is recommended that design professionals specify use of E 1592, because it gives a better representation of the system's uplift performance capability. At the building shown in Figure 6-67, three of the standing seams opened up (unlatched). In the opened condition, the panels were very susceptible to progressive failure, and they were no longer in a watertight condition. At other roof areas, several panels were blown off. ASTM E 1592 is more suitable than UL 580 for assessing the potential for panels to unlatch. Note the air terminal ("lightning rod") shown by the red arrow. The lightning protection system (LPS) conductor ran underneath the ridge flashing. By being concealed underneath the ridge flashing, the conductor was shielded from the wind, (as recommended in Section 6.3.4.4) and was therefore not susceptible to blow-off.





**Figure 6-67:**  
Three of the panel ribs opened up (one to the right of the blue arrow and two to the left). The LPS conductor serving the air terminal (red arrow) ran underneath the ridge flashing. Estimated wind speed: 105–115 mph. Hurricane Ivan (Florida, 2004)

### Load Resistance

Load resistance is commonly specified by a Factory Mutual Research (FMR) rating, such as FM 1-75. The first number (1) indicates that the roof assembly passed the FMR tests for a Class 1 fire rating. The second number (75) indicates the uplift resistance in pounds per square foot (psf) that the assembly achieved during testing. With a safety factor of two this assembly would be suitable for a maximum design uplift load of 37.5 psf.

The highest uplift load occurs at the roof corners because of building aerodynamics as discussed in Section 6.1.3. The perimeter has a somewhat lower load, while the field of the roof has the lowest load. FMG Property Loss Prevention Data Sheets (dates vary) are formatted so that a roof assembly can be selected for the field of the roof. For the perimeter and corner areas, FMG Data Sheet 1-29 provides three options: 1) use the FMG *Approval Guide* listing if it includes a perimeter and corner fastening method; 2) use a roof system with the appropriate FMG Approval rating in the field, perimeter, and corner, in accordance with Table 1 in FMG Data Sheet 1-29; or 3) use prescriptive recommendations given in FMG Data Sheet 1-29.

FM Global (FMG) is the name of the Factory Mutual Insurance Company and its affiliates. One of FMG's affiliates, Factory Mutual Research (FMR) provides testing services, produces documents that can be used by designers and contractors, and develops test standards for construction products and systems. FMR evaluates roofing materials and systems for resistance to fire, wind, hail, water, foot traffic, and corrosion. Roof assemblies and components are evaluated to establish acceptable levels of performance. Some documents and activities are under the auspices of FMG and others are under FMR.

Although other test labs can test systems using FMG test methods, in order to achieve FMG approval, system testing must be conducted by FMG. Roof assemblies that meet FMG requirements can be found at <https://roofnav.fmgglobal.com/RoomNav/Login.aspx>.

FMG's Loss Prevention Data Sheets can be downloaded from the above Web site. The Data Sheets are not updated on a regular basis. Refer to the Web site to ensure that the current edition is being used.



When perimeter and corner uplift resistance values are based on a prescriptive method rather than testing, the field assembly is adjusted to meet the higher loads in the perimeter and corners by increasing the number of fasteners or decreasing the spacing of adhesive ribbons by a required amount. However, this assumes that the failure is the result of the fastener pulling out from the deck, or that the failure is in the vicinity of the fastener plate, which may not be the case. Also, the increased number of fasteners required by FMG may not be sufficient to comply with the perimeter and corner loads derived from the building code. Therefore, if FMG resistance data are specified, it is prudent for the design professional to specify the resistance for each zone of the roof separately. Using the example cited above, if the field of the roof is specified as 1-75, the perimeter would be specified as 1-130 and the corner would be specified as 1-190.

If the roof system is fully adhered, it is not possible to increase the uplift resistance in the perimeter and corners. Therefore, for fully adhered systems, the uplift resistance requirement should be based on the corner load rather than the field load.

### Roof System Performance

Storm-damage research has shown that sprayed polyurethane foam (SPF) and liquid-applied roof systems are very reliable high-wind performers. If the substrate to which the SPF or liquid-applied membrane is applied does not lift, it is highly unlikely that these systems will blow off. Both systems are also more resistant to leakage after missile impact damage than most other systems. Built-up roofs (BURs) and modified bitumen systems have also demonstrated good wind performance provided the edge flashing/coping does not fail (which happens frequently). The exception is aggregate surfacing, which is prone to blow-off (see Figures 6-14, 6-23, and 6-53). Modified bitumen applied to a concrete deck has demonstrated excellent resistance to progressive peeling after blow-off of the metal edge flashing. Metal panel performance is highly variable. Some systems are very wind resistant, while others are quite vulnerable.

Of the single-ply attachment methods, the paver-ballasted and fully adhered methods are the least problematic. Systems with aggregate ballast are prone to blow-off, unless care is taken in specifying the size of aggregate and the parapet height (see Figures 6-8 and 6-53). The performance of protected membrane roofs (PMRs) with a factory-applied cementitious coating over insulation boards is highly variable. When these boards are installed over a loose-laid membrane, it is critical that an air retarder be incorporated to prevent the membrane from ballooning and disengaging the boards. ANSI/SPRI RP-4 (which is referenced

in the IBC) provides wind guidance for ballasted systems using aggregate, pavers, and cementitious-coated boards.

When fully adhering boards to concrete decks, it is recommended that a planar flatness of a maximum of ¼-inch variation over a 10-foot length (when measured by a straightedge) be specified. Prior to installation of the roof insulation, it is recommended that the planar flatness be checked with a straightedge. If the deck is outside of the ¼-inch variation, it is recommended that the high spots be ground or the low spots be suitably filled.

The *Wind Design Guide for Mechanically Attached Flexible Membrane Roofs*, B1049 (National Research Council of Canada, 2005) provides recommendations related to mechanically attached single-ply and modified bituminous systems. B1049 is a comprehensive wind design guide that includes discussion on air retarders. Air retarders can be effective in reducing membrane flutter, in addition to being beneficial for use in ballasted single-ply systems. When a mechanically attached system is specified, careful coordination with the structural engineer in selecting deck type and thickness is important.

When fully adhering insulation boards, it is recommended that the boards be no larger than 4 feet by 4 feet. It is also recommended that the board thickness not exceed 2 inches (1½ inches is preferable). Use of small thin boards makes it easier for the contractor to conform the boards to the substrate. At the building shown in Figure 6-68, 4-foot by 8-foot insulation boards were set in hot asphalt over a concrete deck. A few of the boards detached from the deck. The boards may have initiated the membrane blow-off, or the membrane blow-off may have been initiated by lifting and peeling of the metal edge flashing, in which case, loss of the insulation boards was a secondary failure.



**Figure 6-68:** The blown off insulation (red arrow) may have initiated blow-off of the roof membrane. Estimated wind speed: 105–115 mph. Hurricane Ivan (Florida, 2004)

For metal panel and metal shingle roof system design and application recommendations, FEMA P-499, Fact Sheet 7.6, *Metal Roof Systems in High-Wind Regions*, (2010), is available at <http://www.fema.gov/library/viewRecord.do?id=2138>.

When specifying a mechanically attached single-ply membrane, if a steel deck is selected, it is critical to specify that the membrane fasteners be attached in rows perpendicular to the steel flanges to avoid overstressing the attachment of the deck to the deck support structure. At the school shown in Figure 6-69, the fastener rows of the mechanically attached single-ply membrane ran parallel to the

top flange of the steel deck. The deck fasteners were overstressed and a portion of the deck blew off and the membrane progressively tore. When membrane fasteners run parallel to the flange, the flange with membrane fasteners essentially carries the entire uplift load because of the deck's inability to transfer any significant load to adjacent flanges. Hence, at the joists shown in Figure 6-68, the deck fasteners on either side of the flange with the membrane fasteners are the only connections to the joist that are carrying substantial uplift load.

**Figure 6-69:**  
The orientation of the membrane fastener rows led to blow-off of the steel deck. Hurricane Marilyn (U.S. Virgin Islands, 1995)



### Edge Flashings and Copings

Roof membrane blow-off is almost always a result of lifting and peeling of the metal edge flashing or coping, which serves to clamp down the membrane at the roof edge. Therefore, it is important for the design professional to carefully consider the design of metal edge flashings, copings, and the nailers to which they are attached. The metal edge flashing on the modified bitumen membrane roof shown in Figure 6-70 was installed

underneath the membrane, rather than on top of it, and then stripped in. In this location, the edge flashing was unable to clamp the membrane down. At one area, the membrane was not sealed to the flashing. An ink pen was inserted into the opening prior to photographing to demonstrate how wind could catch the opening and lift and peel the membrane.



**Figure 6-70:**  
The ink pen shows an opening that the wind can catch to cause lifting and peeling of the membrane.

ANSI/SPRI ES-1 provides general design guidance including a methodology for determining the outward-acting load on the vertical flange of the flashing/coping (ASCE 7 does not provide this guidance). ANSI/SPRI ES-1 is referenced in the IBC. ANSI/SPRI ES-1 also includes test methods for assessing flashing/coping resistance. This manual recommends a minimum safety factor of 3 for edge flashings, copings, and nailers for schools. For FMG-insured facilities, FMR-approved flashing should be used and FM Data Sheet 1-49 should also be consulted.

The traditional edge flashing/coping attachment method relies on concealed cleats that can deform under wind load and lead to disengagement of the flashing/coping (see Figure 6-71) and subsequent lifting and peeling of the roof membrane. When a vertical flange disengages and lifts up, the edge flashing and membrane are very susceptible to failure. Normally, when a flange lifts, the failure continues to propagate and the metal edge flashing and roof membrane blows off.



**Figure 6-71:**  
The metal edge flashing on this building disengaged from the continuous cleat and the vertical flange lifted. Hurricane Hugo (South Carolina, 1989)



At the building shown in Figure 6-72, the cleat nailing provided very little resistance to outward deflection of the cleat and coping. While most of the continuous inner and outer cleats remained on the building, several sections of coping and at least one cleat blew off once the amount of deflection was sufficient for the coping to disengage from the cleat. In this case, the roof membrane did not lift and peel as often happens when the coping blows off. However, the coping debris did gouge the roof membrane. Note that the base flashing was stopped at the top of the parapet. It should have been run across the top of the nailer and turned down and nailed so as to provide greater watertight protection in the event of coping leakage or coping blow-off.

**Figure 6-72:**  
The coping blew off because of inadequate attachment of the cleats. Estimated wind speed: 92 mph. Hurricane Ike (Texas, 2008)





Storm-damage research has revealed that, in lieu of cleat attachment, the use of exposed fasteners to attach the vertical flanges of copings and edge flashings is a very effective and reliable attachment method. The coping shown in Figure 6-73 was attached with ¼-inch diameter stainless steel concrete spikes at 12 inches on center. When the fastener is placed in wood, #12 stainless steel screws with stainless steel washers are recommended. The fasteners should be more closely spaced in the corner areas (the spacing will depend upon the design wind loads). ANSI/SPRI ES-1 provides guidance on fastener spacing and thickness of the coping and edge flashing.



**Figure 6-73:** Both vertical faces of the coping were attached with exposed fasteners instead of concealed cleats. Typhoon Paka (Guam, 1997)

### Gutters and Downspouts

Storm-damage research has shown that gutters are seldom designed and constructed to resist wind loads. At the school shown in Figure 6-74, the gutter brackets were attached with a fastener near the top and bottom of the bracket. Hence, the fasteners prevented the brackets from rotating out from the wall. However, because the gutter was not attached to the brackets, the gutter blew away. When a gutter lifts, it typically causes the edge flashing that laps into the gutter to lift as well. Frequently, this results in a progressive lifting and peeling of the roof membrane. The membrane blow-off shown in Figure 6-75 was initiated by gutter uplift. The gutter was similar to that shown in Figure 6-74. The membrane blow-off caused significant interior water damage.

Figure 6-74: Because this gutter was not attached to the bracket, wind lifted the gutter along with the metal edge flashing that lapped into the gutter. Bracket fasteners are indicated by the red arrows. Hurricane Francis (Florida, 2004)



Figure 6-75: The original modified bitumen membrane was blown away after the gutter lifted in the area shown by the red arrow (the black membrane is a temporary roof). Hurricane Francis (Florida, 2004)



Special design attention needs to be given to attaching gutters to prevent uplift, particularly for those in excess of 6 inches in width. Currently, there are no design guides or standards pertaining to gutter wind resistance. It is recommended that the designer calculate the uplift load on gutters using the overhang coefficient from ASCE 7. There are two approaches to resist gutter uplift.

- Gravity-support brackets can be designed to resist uplift loads. In these cases, in addition to being attached at its top, the bracket should also be attached at its low end to the wall (as was the case for the brackets shown in Figure 6-74). The gutter also needs to be designed so it is attached securely to the bracket in a way that will effectively transfer the gutter uplift load to the bracket (see Figure 6-76). Bracket spacing

will depend on the gravity and uplift load, the bracket's strength, and the strength of connections between the gutter/bracket and the bracket/wall. With this option, the bracket's top will typically be attached to a wood nailer, and that fastener will be designed to carry the gravity load. The bracket's lower connection will resist the rotational force induced by gutter uplift. Because brackets are usually spaced close together to carry the gravity load, developing adequate connection strength at the lower fastener is generally not difficult. Screws rather than nails are recommended to attach brackets to the building because screws are more resistant than nails to dynamically induced pull-out forces.



**Figure 6-76:** At this gutter, a fastener connected the bracket to the gutter. Note: To avoid leakage at the fasteners between the bracket and gutter, the bracket should extend near or to the top of the gutter so that the fastener would be above the waterline. Estimated wind speed: 95 mph. Hurricane Ike (Texas, 2008)

- The other option is to use gravity-support brackets only to resist gravity loads, and use separate sheet-metal straps at 45-degree angles to the wall to resist uplift loads (Figure 6-77). Strap spacing will depend on the gutter uplift load and strength of the connections between the gutter/strap and the strap/wall. Note that FMG Data Sheet 1-49 recommends placing straps 10 feet apart. However, at that spacing with wide gutters, fastener loads induced by uplift are quite high. When straps are spaced at 10 feet, it can be difficult to achieve sufficiently strong uplift connections.

When designing a bracket's lower connection to a wall or a strap's connection to a wall, designers should determine appropriate screw pull-out values. With this option, a minimum of two screws at each end of a strap is recommended. At a wall, screws should be placed side by side, rather than vertically aligned, so the strap load is carried equally by the two fasteners. When fasteners are vertically aligned, most of the load is carried by the top fastener.

**Figure 6-77:**  
Sheet metal straps  
were attached to an  
existing gutter that  
lacked sufficient uplift  
resistance.



Since the uplift load in the corners is much higher than the load between the corners, enhanced attachment is needed in corner areas regardless of the option chosen. ASCE 7 provides guidance about determining a corner area's length.

Storm damage research has also shown that downspouts are seldom designed and constructed to resist wind loads (see Figure 6-78). Special design attention needs to be given to attaching downspouts to prevent blow-off. Currently there are no design guides or standards pertaining to downspout wind resistance. The keys to achieving successful performance include providing brackets that are not excessively spaced, bracket strength, and the strength of the connections between the brackets and wall.

### Parapet Base Flashings

Information on loads for parapet base flashings was first introduced in the 2002 edition of ASCE 7. The loads on base flashings are greater than the loads on the roof covering if the parapet's exterior side is air-permeable. When base flashing is fully adhered, it has sufficient wind resistance in most cases. However, when base flashing is mechanically fastened, typical fastening patterns may be inadequate, depending on design wind conditions (see Figure 6-79). Therefore, it is imperative that the base flashing loads be calculated, and attachments be designed to accommodate these loads. It is also important for designers to specify the attachment spacing in parapet corner regions to differentiate them from the regions between corners.





**Figure 6-78:**  
Blow-off of this downspout resulted in glazing breakage. Estimated wind speed: 105–115 mph. Hurricane Ivan (Florida, 2004)



**Figure 6-79:**  
If mechanically attached base flashings have an insufficient number of fasteners, the base flashing can be blown away. Hurricane Andrew (Florida, 2004)

When the roof membrane is specified to be adhered, it is recommended that fully adhered base flashings be specified in lieu of mechanically attached base flashings. Otherwise, if the base flashing is mechanically attached, ballooning of the base flashing during high winds can lead to lifting and progressive peeling of the roof membrane.



## Steep-Slope Roof Coverings

For a discussion of wind performance of asphalt shingle (see Figure 6-12) and tile roof coverings (see Figure 6-83), see FEMA 488, FEMA 489, FEMA 549, and FEMA P-757. For recommendations pertaining to asphalt shingles and tiles, see Fact Sheets 7.1, 7.2, and 7.3 in FEMA P-499.

For design and application recommendations pertaining to roof vents, see FEMA P-499, Fact Sheet 7.5, *Minimizing Water Intrusion Through Roof Vents in High-Wind Regions*, (2010), available at <http://www.fema.gov/library/viewRecord.do?id=2138>.

### 6.3.3.7 Roof Systems in Hurricane-Prone Regions

The following types of roof systems are recommended for schools in hurricane-prone regions, because they are more likely to avoid water infiltration if the roof is hit by wind-borne debris, and also because these systems are less likely to become sources of wind-borne debris:

- In tropical climates where insulation is not needed above the roof deck, specify either liquid-applied membrane over cast-in-place concrete deck, or modified bitumen membrane torched directly to primed cast-in-place concrete deck.
- Install a secondary membrane over a concrete deck (if another type of deck is specified, a cover board may be needed over the deck). Seal the secondary membrane at perimeters and penetrations. Specify rigid insulation over the secondary membrane. Where the basic wind speed is up to 150 mph,<sup>25</sup> a minimum 2-inch thick layer of insulation is recommended. Where the speed is between 150 and 175 mph,<sup>26</sup> a total minimum thickness of 3 inches is recommended (installed in two layers). Where the speed is greater than 175 mph, a total minimum thickness of 4 inches is recommended (installed in two layers). A layer of 5/8-inch thick glass mat gypsum roof board is recommended over the insulation, followed by a modified bitumen membrane. A modified bitumen membrane is recommended for the primary membrane because of its somewhat enhanced resistance to puncture by small missiles compared with other types of roof membranes.

25 The 150-mph basic wind speed is based on ASCE 7-10, Risk Category III and IV buildings. If ASCE 7-05 or an earlier version is used, the equivalent wind speed trigger is 110 mph.

26 The 150- to 175-mph basic wind speed is based on ASCE 7-10, Risk Category III and IV buildings. If ASCE 7-05 or an earlier version is used, the equivalent wind speed trigger is between 110 and 130 mph.

The purpose of the insulation and gypsum roof board is to absorb missile energy. If the primary membrane is punctured or blown off during a storm, the secondary membrane should provide watertight protection unless the roof is hit with missiles of very high momentum that penetrate the insulation and secondary membrane. Figure 6-80 illustrates the merit of specifying a secondary membrane. Although the copper roof blew off, fortunately there was a very robust underlayment (a built-up membrane) that remained in place. The minor leakage that occurred did not impair building operations.



**Figure 6-80:**  
The secondary membrane prevented significant leakage into the building after the copper roof blew off. Hurricane Andrew (Florida, 1992)

For an SPF roof system over a concrete deck (if another type of deck is specified, a cover board may be needed over the deck), where the basic wind speed is less than 175 mph,<sup>27</sup> it is recommended that the foam be a minimum of 3 inches thick to avoid missile penetration through the entire layer of foam. Where the speed is greater than 175 mph, a 4-inch minimum thickness is recommended. It is also recommended that the SPF be coated, rather than protected with an aggregate surfacing.

With respect to wind-borne debris, SPF behaves quite differently than other types of roof coverings. Except for paver-ballasted systems, other types of coverings (including tough membranes such as modified bitumen and metal panels) can be easily penetrated by debris. When these other types of coverings are punctured, water enters the roof system and typically leaks into the building unless there is a secondary membrane.

<sup>27</sup> The 175-mph basic wind speed is based on ASCE 7-10, Risk Category III and IV buildings. If ASCE 7-05 or an earlier version is used, the equivalent wind speed trigger is 130 mph.

With SPF, missiles can gouge the foam (as shown in Figure 6-81), but it is rare for missiles to completely penetrate through the foam. When a quality SPF is gouged, only an insignificant amount of moisture is absorbed into the foam cells at the gouged area, even if the gouge is not repaired for several months.

**Figure 6-81:**  
Although a missile cut into the SPF, the roof was still watertight. The ink pen (blue arrow) shows the relative size of the impact area. Estimated wind speed: 110 mph. Hurricane Ike (Texas, 2008)



- For a PMR, it is recommended that pavers weighing a minimum of 22 psf be specified. In addition, base flashings should be protected with metal (such as shown in Figure 6-88) to provide debris protection. Parapets with a 3-foot minimum height (or higher if so indicated by ANSI/SPRI RP-4) are recommended at roof edges. This manual recommends that PMRs not be used for schools in hurricane-prone regions where the basic wind speed exceeds 175 mph.<sup>28</sup>
- For structural metal roofs, it is recommended that a roof deck be specified, rather than attaching the panels directly to purlins as is commonly done with pre-engineered metal buildings. If panels blow off buildings without roof decking, wind-borne debris and rain are free to enter the building.

Structural standing seam metal roof panels with concealed clips and mechanically seamed ribs spaced at 12 inches on center are recommended. If the panels are installed over a concrete deck, a modified bitumen secondary membrane is recommended if the deck has a slope less than ½:12. If the panels are installed over

<sup>28</sup> The 175-mph basic wind speed is based on ASCE 7-10, Risk Category III and IV buildings. If ASCE 7-05 or an earlier version is used, the equivalent wind speed trigger is 130 mph.



a steel deck or wood sheathing, a modified bitumen secondary membrane (over a suitable cover board when over steel decking) is recommended, followed by rigid insulation and metal panels. Where the basic wind speed is up to 150 mph,<sup>29</sup> a minimum 2-inch thick layer of insulation is recommended. Where the speed is between 150 and 175 mph,<sup>30</sup> a total minimum thickness of 3 inches is recommended. Where the speed is greater than 175 mph, a total minimum thickness of 4 inches is recommended. Although some clips are designed to bear on insulation, it is recommended that the panels be attached to wood nailers attached to the deck, because nailers provide a more stable foundation for the clips.

If the metal panels are blown off or punctured during a hurricane, the secondary membrane should provide watertight protection unless the roof is hit with missiles of very high momentum. At the roof shown in Figure 6-82, the structural standing seam panel clips bore on rigid insulation over a steel deck. Had a secondary membrane been installed over the steel deck, the membrane would have likely prevented significant interior water damage and facility disruption.



**Figure 6-82: Significant interior water damage and facility interruption occurred after the standing seam roof blew off. Hurricane Marilyn (U.S. Virgin Islands, 1995)**

29 The 150-mph basic wind speed is based on ASCE 7-10, Risk Category III and IV buildings. If ASCE 7-05 or an earlier version is used, the equivalent wind speed trigger is 110 mph.

30 The 150- to 175-mph basic wind speed is based on ASCE 7-10, Risk Category III and IV buildings. If ASCE 7-05 or an earlier version is used, the equivalent wind speed trigger is between 110 and 130 mph.

Based on field performance of architectural metal panels in hurricane-prone regions, exposed fastener panels are recommended in lieu of architectural panels with concealed clips. For panel fasteners, stainless steel screws are recommended. A secondary membrane protected with insulation is recommended, as discussed above for structural standing seam systems.

In order to avoid the possibility of roofing components blowing off and causing damage to other portions of the school or striking people arriving at a school shelter during a storm, the following roof systems are not recommended: aggregate surfacings, either on BUR, single-ply, or SPF; lightweight concrete pavers; cementitious-coated insulation boards; slate; and tile (see Figures 6-83 and 6-84). Even when slates and tiles are properly attached to resist wind loads, their brittleness makes them vulnerable to breakage as a result of wind-borne debris impact. The tile and slate fragments can be blown off the roof, and fragments can damage other parts of the roof causing a cascading failure.

The tiles shown in Figure 6-83 were attached with the foam-adhesive (adhesive-set) method. The tiles shown in Figure 6-84 were attached with the wire-tied method (an uncommon method in the eastern portion of the United States). In addition to the wire attachments, the tiles were also attached with stainless steel clips at the first three rows from the eave. All of the tiles had tail hooks, and adhesive was used between the tail and head of all tiles. Except for the three perimeter rows which were clipped, the wires did not prevent the tiles from lifting a short distance above the concrete deck. The failure was attributed to tiles lifting and then slamming back down on the deck, where upon they broke and the tile fragments blew away.

**Figure 6-83:**  
Brittle roof coverings, like slate and tile, can be broken by missiles, and tile debris can break other tiles. Estimated wind speed: 140–160 mph. Hurricane Charley (Florida, 2004)







**Figure 6-84**  
These wire-tied tiles were installed over a concrete deck. The failure was attributed to lack of vertical restraint, which allowed the tiles to lift and then be broken when they slammed back down onto the deck. Typhoon Paka (Guam, 1997)

Mechanically attached and air-pressure equalized single-ply membrane systems are susceptible to massive progressive failure after missile impact, and are therefore not recommended for schools in hurricane-prone regions. At the school shown in Figure 6-85, a missile struck the fully adhered low-sloped roof and slid into the steep-sloped reinforced mechanically attached single-ply membrane in the vicinity of the red arrow. A large area of the mechanically attached membrane was blown away as a result of progressive membrane tearing. Fully adhered single-ply membranes are very vulnerable to missile puncture and are not recommended unless they are ballasted with pavers.



**Figure 6-85:** This mechanically attached single-ply membrane progressively tore after being cut by wind-borne debris. Hurricane Andrew (Florida, 1992)

**Edge flashings and copings:** If cleats are used for attachment, it is recommended that a “peel-stop” bar be placed over the roof membrane near the edge flashing/coping, as illustrated in Figure 6-86. The purpose of the bar is to provide secondary protection against membrane lifting and peeling in the event that edge flashing/coping fails. A robust bar specifically made for bar-over mechanically attached single-ply systems is recommended. The bar needs to be very well anchored to the parapet or the deck. Depending on design wind loads, spacing between 4 and 12 inches on center is recommended. A gap of a few inches should be left between each bar to allow for water flow across the membrane. After the bar is attached, it is stripped over with a stripping ply.

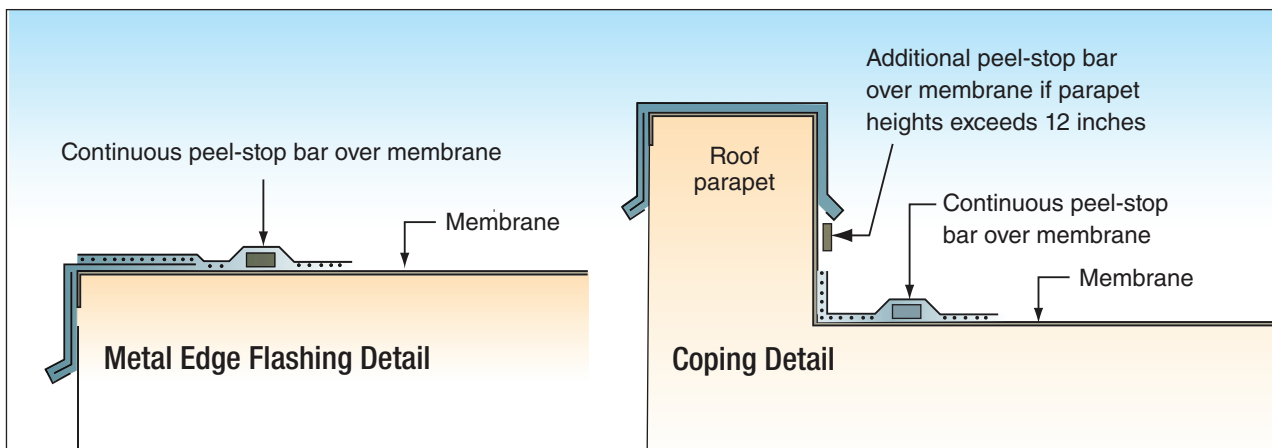

**Figure 6-86:** A continuous peel-stop bar over the membrane may prevent a catastrophic progressive failure if the edge flashing or coping is blown off. (Modified from FEMA 55, 2000)

**Walkway pads:** Roof walkway pads are frequently blown off during hurricanes (Figure 6-87). Pad blow-off does not usually damage the roof membrane. However, wind-borne pad debris can damage other building components and injure people. Currently there is no test standard to evaluate uplift resistance of walkway pads. Walkway pads are therefore not recommended in hurricane-prone regions.

**Parapets:** For low-sloped roofs, minimum 3-foot high parapets are recommended. With parapets of this height or greater, the uplift load in the corner region is substantially reduced (ASCE 7 permits treating the corner zone as a perimeter zone). Also, a high parapet (as shown in Figure 6-106) may intercept wind-borne debris and keep it from blowing off the roof and damaging other building components or injuring people. To protect base flashings from wind-borne debris damage and subsequent water leakage, it is recommended that metal panels on furring strips be installed over the base flashing (Figure 6-88). Exposed stainless steel screws are recommended for attaching the panels to the furring strips, because using exposed fasteners is more reliable than using concealed fasteners or clips (as were used for the failed panels shown in Figure 6-64).



**Figure 6-87:**  
Several rubber walkway pads were blown off the single-ply membrane roof. Estimated wind speed: 130 mph. Hurricane Katrina (Mississippi, 2005)



**Figure 6-88:**  
Base flashing protected by metal wall panels attached with exposed screws. Estimated wind speed: 120 mph. Hurricane Katrina (Mississippi, 2005)



### 6.3.4 Nonstructural Systems and Equipment

Nonstructural systems and equipment include all components that are not part of the structural system or building envelope. Exterior-mounted mechanical equipment (e.g., exhaust fans, HVAC units, relief air hoods, rooftop ductwork, and boiler stacks), electrical equipment (e.g., light fixtures and LPSs), and communications equipment (e.g., antennae and satellite dishes) are often damaged during high winds. Damaged equipment can impair the operation of the facility, the equipment can detach and become wind-borne missiles, and water can enter the facility where equipment was displaced (see Figure 6-89). The most common problems typically relate to inadequate equipment anchorage, inadequate strength of the equipment itself, and corrosion.

**Figure 6-89:**  
This gooseneck was attached with only two small screws. Emergency repairs had not been made at the time this photograph was taken, which was 5 days after the hurricane struck. A substantial amount of water was able to enter the school. Hurricane Francis (Florida, 2004)

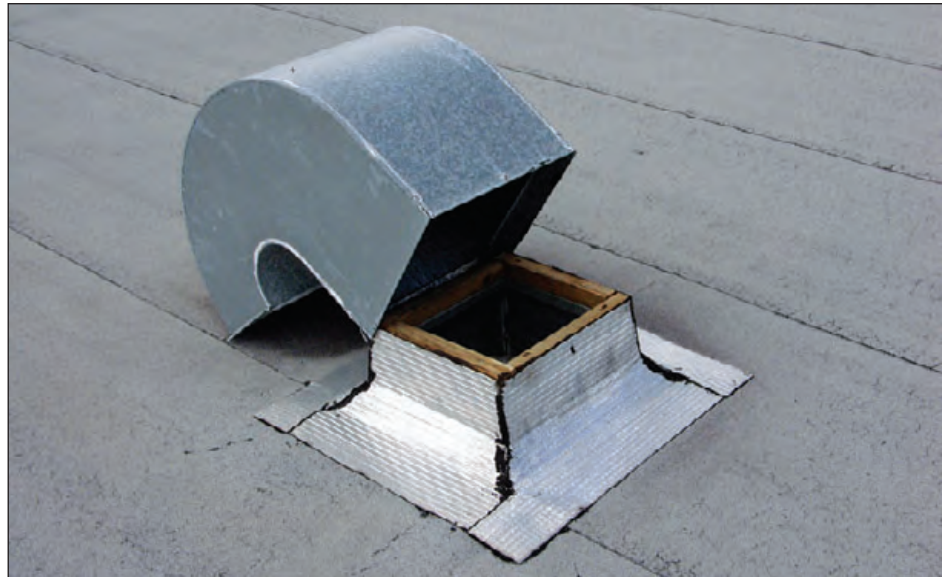

Exterior-mounted equipment is especially vulnerable to hurricane-induced damage, and special attention should be paid to positioning and mounting of these components in hurricane-prone regions. See Sections 6.3.4.2 and 6.3.4.4 for additional information pertaining to schools located in hurricane-prone regions.

#### 6.3.4.1 Exterior-Mounted Mechanical Equipment

This section discusses loads and attachment methods, as well as the problems of corrosion and water infiltration.

##### Loads and Attachment Methods

Information on loads on rooftop equipment was first introduced in the 2002 edition of ASCE 7. For guidance on load calculations, see *Calculating Wind Loads and Anchorage Requirements for Rooftop Equipment*

(ASHRAE, 2006). A minimum safety factor of 3 is recommended for schools. Loads and resistance should also be calculated for heavy pieces of equipment since the dead load of the equipment is often inadequate to resist the design wind load. The 30-foot by 10-foot by 8-foot 18,000-pound HVAC unit shown in Figure 6-90 was attached to its curb with 16 straps (one screw per strap). Although the wind speeds were estimated to be only 85 to 95 miles per hour (peak gust), the HVAC unit blew off the building. The inset at Figure 6-90 shows the curb upon which the unit was attached. A substantial amount of water entered the building at the curb openings before the temporary tarp was placed.

Mechanical penetrations through the elevator penthouse roof and walls must possess adequate wind and water resistance to ensure continuity of elevator service (see Section 6.3.3.4). In addition to paying special attention to equipment attachment, air intakes and exhausts should be designed and constructed to prevent wind-driven water from entering the penthouse.



**Figure 6-90:**  
Although this 18,000-pound HVAC unit was attached to its curb with 16 straps, it blew off the building during Hurricane Ivan. (Florida, 2004)

To anchor fans, small HVAC units, and relief air hoods, the minimum attachment schedule provided in Table 6-1 is recommended. The attachment of the curb to the roof deck also needs to be designed and constructed to resist wind loads. The cast-in-place concrete curb shown in Figure 6-91 was cold-cast over a concrete roof deck. Dowels were not installed between the deck and curb, hence a weak connection occurred.



**Table 6-1: Number of #12 screws for base case attachment of rooftop equipment**

Case No	Curb Size and Equipment Type	Equipment Attachment	Fastener Factor for Each Side of Curb or Flange
1	12" x 12" Curb with Gooseneck Relief Air Hood	Hood Screwed to Curb	1.6
2	12" x 12" Gooseneck Relief Air Hood with Flange	Flange Screwed to 22 Gauge Steel Roof Deck	2.8
3	12" x 12" Gooseneck Relief Air Hood with Flange	Flange Screwed to 15/32" OSB Roof Deck	2.9
4	24" x 24" Curb with Gooseneck Relief Air Hood	Hood Screwed to Curb	4.6
5	24" x 24" Gooseneck Relief Air Hood with Flange	Flange Screwed to 22 Gauge Steel Roof Deck	8.1
6	24" x 24" Gooseneck Relief Air Hood with Flange	Flange Screwed to 15/32" OSB Roof Deck	8.2
7	24" x 24" Curb with Exhaust Fan	Fan Screwed to Curb	2.5
8	36" x 36" Curb with Exhaust Fan	Fan Screwed to Curb	3.3
9	5'-9" x 3'- 8" Curb with 2'- 8" high HVAC Unit	HVAC Unit Screwed to Curb	4.5*
10	5'-9" x 3'- 8" Curb with 2'- 8" high Relief Air Hood	Hood Screwed to Curb	35.6*

**Notes to Table 6-1:**

- The loads are based on ASCE 7-05. The resistance includes equipment weight. When using ASCE 7-10, convert the 7-10 Category III / IV basic wind speed to a 7-05 basic wind speed as follows: 7-10 speed divided by the square root of  $(1.15 \times 1.6) = 7-05$  speed.
- The Base Case for the tabulated numbers of #12 screws (or ¼ pan-head screws for flange-attachment) is a 90-mph basic wind speed, 1.15 importance factor, 30' building height, Exposure C, using a safety factor of 3. The 7-05 Base Case is equivalent to 120 mph for 7-10 Risk Category III and IV buildings.
- For other basic wind speeds, multiply the tabulated number of #12 screws by  $\left(\frac{V_D^2}{90^2}\right)$  to determine the required number of #12 screws (or ¼ pan-head screws) required for the desired basic wind speed,  $V_D$  (mph).
- For other roof heights up to 200', multiply the tabulated number of #12 screws by  $(1.00 + 0.003 [h - 30])$  to determine the required number of #12 screws or ¼ pan-head screws for buildings between 30' and 200'.

Example A: 24" x 24" exhaust fan screwed to curb (table row 7), Base Case conditions (see Note 1): 2.5 screws per side; therefore, round up and specify 3 screws per side.

Example B: 24" x 24" exhaust fan screwed to curb (table row 7), Base Case conditions, except 120 mph:  $120^2 \times 1 \div 90^2 = 1.78 \times 2.5$  screws per side = 4.44 screws per side; therefore, round down and specify 4 screws per side.

Example C: 24" x 24" exhaust fan screwed to curb (table row 7), Base Case conditions, except 150' roof height:  $1.00 + 0.003 (150' - 30') = 1.00 + 0.36 = 1.36 \times 2.5$  screws per side = 3.4 screws per side; therefore, round down and specify 3 screws per side.

- \* This factor only applies to the long sides. At the short sides, use the fastener spacing used at the long sides.



**Figure 6-91:**  
The gooseneck on this building remained attached to the curb, but the curb detached from the deck. Typhoon Paka (Guam, 1997)

**Fan cowling attachment:** Fans are frequently blown off their curbs because they are poorly attached. When fans are well attached, the cowlings frequently blow off during high winds (see Figure 6-92). Blown-off cowlings can tear roof membranes and break glazing. Unless the fan manufacturer specifically engineered the cowling attachment to resist the design wind load, cable tie-downs (see Figure 6-93) are recommended to avoid cowling blow-off where the basic wind speed is greater than 120 mph.<sup>31</sup> For fan cowlings less than 4 feet in diameter,  $\frac{1}{8}$ -inch diameter stainless steel cables are recommended. For larger cowlings, use  $\frac{3}{16}$ -inch diameter cables. When the basic wind speed is 165 mph or less, specify two cables.<sup>32</sup> Where the basic wind speed is greater than 165 mph, specify four cables. To minimize leakage potential at the anchor point, it is recommended that the cables be adequately anchored to the equipment curb (rather than anchored to the roof deck). The attachment of the curb itself also needs to be designed and specified.

To avoid corrosion-induced failure (Figure 6-105), it is recommended that exterior-mounted mechanical, electrical, and communications equipment be made of nonferrous metals, stainless steel, or steel with minimum G-90 hot-dip galvanized coating for the equipment body, stands, anchors, and fasteners. When equipment with enhanced corrosion protection is not available, the designer should advise the building owner that periodic equipment maintenance and inspection is particularly important to avoid advanced corrosion and subsequent equipment damage during a windstorm.

31 The 120-mph basic wind speed is based on ASCE 7-10, Risk Category III and IV buildings. If ASCE 7-05 or an earlier version is used, the equivalent wind speed trigger is 90 mph.

32 The 165-mph basic wind speed is based on ASCE 7-10, Risk Category III and IV buildings. If ASCE 7-05 or an earlier version is used, the equivalent wind speed trigger is 120 mph.

**Figure 6-92:**  
Cowlings blew off two of the three fans. Note also the loose LPS conductors and missing walkway pad (red arrow). Estimated wind speed: 140–160 mph. Hurricane Charley (Florida, 2004)



**Figure 6-93:**  
Cables were attached to prevent the cowling from blowing off. Typhoon Paka (Guam, 1997)



**Ductwork:** To avoid wind and wind-borne debris damage to rooftop ductwork, it is recommended that ductwork not be installed on the roof (see Figure 6-138). If ductwork is installed on the roof, it is recommended that the ducts' gauge and the method of attachment be able to resist the design wind loads.

**Condenser attachment:** In lieu of placing rooftop-mounted condensers on wood sleepers resting on the roof (see Figure 6-94), it is recommended that condensers be anchored to equipment stands. The attachment of the stand to the roof deck also needs to be designed to resist the design loads. In addition to anchoring the base of the condenser to the stand,



two metal straps with two side-by-side #12 screws or bolts with proper end and edge distances at each strap end are recommended where the basic wind speed is greater than 120 mph (see Figure 6-95).<sup>33</sup>



**Figure 6-94:** These condensers were blown off their sleepers. Displaced condensers can rupture roof membranes and refrigerant lines. Estimated wind speed: 120 mph. Hurricane Katrina (Mississippi)

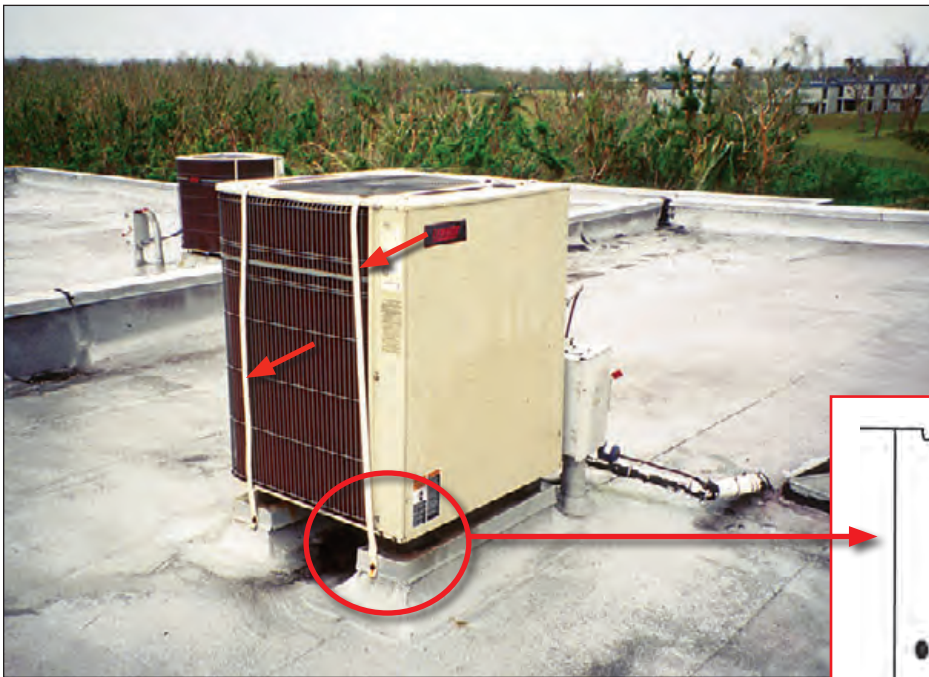

**Figure 6-95:** This condenser had supplemental attachment straps (see red arrows). Typhoon Paka (Guam, 1997)

<sup>33</sup> The 120-mph basic wind speed is based on ASCE 7-10, Risk Category III and IV buildings. If ASCE 7-05 or an earlier version is used, the equivalent wind speed trigger is 90 mph.

**Vibration isolators:** If vibration isolators are used to mount equipment, only those able to resist design uplift loads should be specified and installed, or an alternative means to accommodate uplift resistance should be provided (see Figure 6-96).

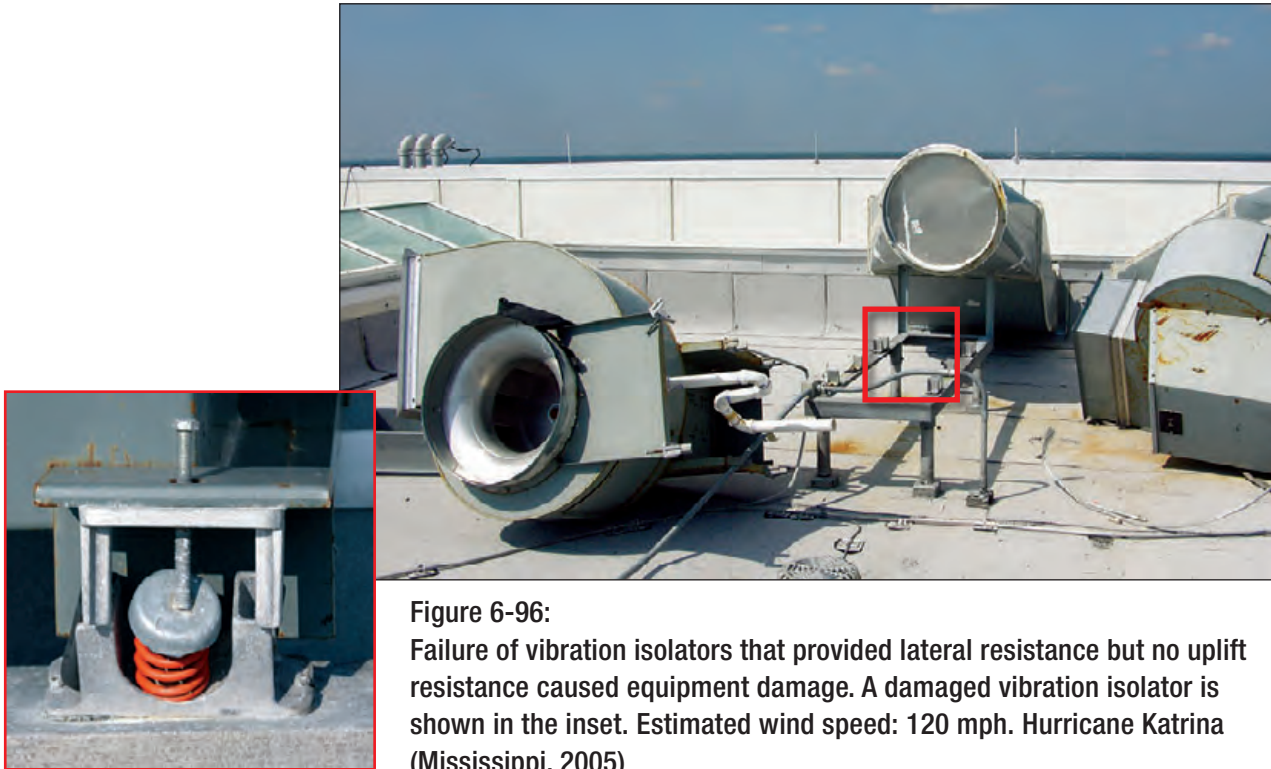

**Figure 6-96:** Failure of vibration isolators that provided lateral resistance but no uplift resistance caused equipment damage. A damaged vibration isolator is shown in the inset. Estimated wind speed: 120 mph. Hurricane Katrina (Mississippi, 2005)

**Boiler and exhaust stack attachment:** To avoid wind damage to boiler and exhaust stacks, wind loads on stacks should be calculated and guy-wires should be designed and constructed to resist the loads. Toppled stacks, as shown at the building in Figure 6-97, can allow water to enter the building at the stack penetration, damage the roof membrane, and become wind-borne debris. The designer should advise the building owner that guy-wires should be inspected annually to ensure they are taut.

Three publications pertaining to seismic restraint of equipment provide general information on fasteners and edge distances:

- FEMA 412, *Installing Seismic Restraints for Mechanical Equipment* (2002)
- FEMA 413, *Installing Seismic Restraints for Electrical Equipment* (2004b)
- FEMA 414, *Installing Seismic Restraints for Duct and Pipe* (2004a)



**Access panel attachment:** Equipment access panels frequently blow off (see Figure 6-98). Unless the equipment manufacturer specifically engineered the panel attachment to resist the design wind load, job-site modifications, such as attaching hasps and locking devices like carabiners, are recommended. The modification details need to be customized. Detailed design may be needed after the equipment has been delivered to the job site. Modification details should be approved by the equipment manufacturer.



**Figure 6-97:** Guyed flue blew over (red arrow indicates one of the guys). Estimated wind speed: 92 mph. Hurricane Ike (Texas, 2008)



**Figure 6-98:** The school shown in Figure 6-65 also had an access panel blow off. Blown-off panels can puncture roof membranes, break glazing, and cause injury. Estimated wind speed: 85–95 mph. Hurricane Ivan (Florida, 2004)

**Natural gas and condensate drain lines:** Natural gas lines and condensate drain lines serving rooftop HVAC units are seldom anchored to resist wind loads. Gas line rupture can be due to lack of line anchorage or due to HVAC unit blow-off (see Figures 6-57 and 6-99). Where the basic wind speed is greater than 120 mph,<sup>34</sup> it is recommended that gas line supports be designed and constructed to resist the design wind load (see Figure 6-100).

**Figure 6-99:**  
The school shown in Figures 6-65 and 6-98 also experienced gas line rupture (shown by the lines dangling over the side of the building). Estimated wind speed: 85–95 mph. Hurricane Ivan (Florida, 2004)



**Figure 6-100:**  
At a periodic gas line support on this roof, a steel angle was welded to a pipe that was anchored to the roof deck. A strap looped over the gas line and was bolted to the support angle. Such a connection provides resistance to lateral and uplift loads.



<sup>34</sup> The 120-mph basic wind speed is based on ASCE 7-10, Risk Category III and IV buildings. If ASCE 7-05 or an earlier version is used, the equivalent wind speed trigger is 90 mph.

Although blow-off of condensate drain lines is not as potentially catastrophic as rupture of gas lines, blown off condensate drain lines can puncture roof membranes, break glazing, and cause injury (see Figure 6-101). Where the basic wind speed is greater than 120 mph,<sup>35</sup> it is recommended that condensate drain line supports be designed and constructed to resist the design wind load.



**Figure 6-101:** These two condensate drain lines detached from their HVAC units. They had not been anchored to the roof. Estimated wind speed: 125 mph. Hurricane Katrina (Mississippi, 2005)

**Equipment screens:** Screens around rooftop equipment are frequently blown away (see Figure 6-102). Screens should be designed to resist the wind load derived from ASCE 7. Since the effect of screens on equipment wind loads is unknown, the equipment attachment behind the screens should be designed to resist the design load.

### Water Infiltration

During high winds, wind-driven rain can be driven through air intakes and exhausts unless special measures are taken. Louvers should be designed and constructed to prevent leakage between the louver and wall. The louver itself should be designed to avoid water being driven past the louver. However, it is difficult to prevent infiltration during very high winds. Designing sumps with drains that will intercept water driving past louvers or air intakes should be considered. ASHRAE 62.1 provides some information on rain and snow intrusion. The *Standard 62.1 User's Manual* (2007a) provides additional information, including examples and illustrations of various designs.

<sup>35</sup> The 120-mph basic wind speed is based on ASCE 7-10, Risk Category III and IV buildings. If ASCE 7-05 or an earlier version is used, the equivalent wind speed trigger is 90 mph.



**Figure 6-102:**  
Equipment screen panels can puncture roof membranes, break glazing, and cause injury. Estimated wind speed: 105–115 mph. Hurricane Ivan (Florida, 2004)



#### 6.3.4.2 Nonstructural Systems and Mechanical Equipment in Hurricane-Prone Regions

**Mechanical Penthouses:** By placing equipment in mechanical penthouses rather than leaving them exposed on the roof, equipment can be shielded from high-wind loads and wind-borne debris (see Figure 6-103). Although screens (such as shown in Figure 6-102) could be designed and constructed to protect equipment from horizontally flying debris, they are not effective in protecting equipment from missiles that have an angular trajectory. It is therefore recommended that mechanical equipment be placed inside mechanical penthouses. The penthouse itself should be designed and constructed in accordance with the recommendations given in Sections 6.3.2.2, 6.3.3.5, and 6.3.3.7.

If rooftop ductwork is exposed on the roof, and if there are flexible connectors between the ducts and fans, the connectors may be punctured by wind-borne debris. If equipment is not protected by a penthouse, the following is recommended:

- Because of their small size, the potential for a flexible connector to be punctured by wind-borne debris is typically very low. However, if site-specific conditions present an unusually high potential for debris damage, it is recommended that the flexible connectors be protected by equipment screens or a custom-designed shield.

As part of annual roof inspections prior to hurricane season, it is recommended that all flexible connectors be inspected. Those found to be in a weathered condition (e.g., cracked, torn, or embrittled) should be immediately replaced.



**Figure 6-103:** This exhaust fan was impacted by wind-borne debris. Although it is often impractical to place all equipment such as fans in penthouses, doing so to the extent possible avoids debris damage. Estimated wind speed: 130 mph. Hurricane Katrina (Mississippi, 2005)

**Roof drainage:** Roof drains and scuppers have the potential to be blocked by leaves, tree limbs, and other wind-borne debris during a hurricane (see Figure 6-104). If primary and overflow drains/scuppers become blocked, development of deep ponding water may inundate base flashings and cause leakage problems or lead to roof collapse. To avoid problems with blocked drains and scuppers, the following are recommended:

- **Scuppers** – Only a relatively small scupper is needed to drain a large roof area, provided the scupper opening is not blocked by debris. However, since small openings are more easily blocked than larger openings, it is recommended that scupper openings be much larger than normal. It is recommended that scupper openings be a minimum of 24 inches wide and 16 inches high. In addition, it is recommended that the distance between scuppers be such that, in the event a scupper becomes blocked, the adjacent scuppers have sufficient capacity to drain the roof.
- **Roof drains** – Avoiding blockage of drains is more problematic than avoiding blockage of scuppers. Drain lines need to be protected by domes to prevent debris from flowing into the lines and blocking them. For domes to be effective in protecting drain lines from

As part of pre-storm preparations, drains, scuppers, and gutters should be cleaned of debris in order to maximize their effectiveness in draining the roof and minimize the potential for their blockage during a hurricane (see Figure 6-32).



blockage, the dome openings must be relatively small. To provide overflow protection, it is recommended that overflow scuppers be provided. Where drainage patterns necessitate that overflow protection be provided by overflow drains (rather than, or in addition to, overflow scuppers), it is recommended that additional overflow drains be installed. By doing so, if both a main drain and its nearby overflow drain become blocked, the additional overflow drain in the vicinity can provide drainage and avoid roof collapse.

**Figure 6-104:**  
Leaf debris and ponding near a scupper (red and blue arrows). The yellow arrow indicates a piece of coping that blew off an upper roof shown in Figure 6-72. Estimated wind speed: 92 mph. Hurricane Ike (Texas, 2008)



#### 6.3.4.3 Exterior-Mounted Electrical and Communications Equipment

Damage to exterior-mounted electrical equipment is infrequent, mostly because of its small size (e.g., disconnect switches). Exceptions include communication towers, surveillance cameras, electrical service masts, satellite dishes, and LPSs. The damage is typically caused by inadequate mounting as a result of failure to perform wind load calculations and anchorage design. Damage is also sometimes caused by corrosion (see Figure 6-105 and text box in Section 6.3.4.1 regarding corrosion).



**Figure 6-105:** Collapsed light fixtures caused by severe corrosion (see inset). Estimated wind speed: 105–115 mph. Hurricane Ivan (Florida, 2004)



**Communication towers and poles:** NFPA 70 provides guidance for determining wind loads on power distribution and transmission poles and towers. AASHTO LTS-4-5 provides guidance for determining wind loads on light fixture poles (standards).

Both ASCE 7 and ANSI/TIA-222-G contain wind load provisions for communication towers (structures). The IBC allows the use of either approach. The ASCE wind load provisions are generally consistent with those contained in ANSI/TIA-222-G. ASCE 7, however, contains provisions for dynamically sensitive towers that are not present in the ANSI/TIA standard. ANSI/TIA classifies towers according to their use (Class I, Class II, and Class III). This manual recommends that towers (including antennae) that are mounted on, located near, or serve schools be designed as Class III structures.

Collapse of both large and small communication towers is quite common during high-wind events (see Figure 6-106). These failures often result in complete loss of communication capabilities. In addition to the disruption of communications, collapsed towers can puncture roof membranes and allow water leakage into the school, unless the roof system incorporated a secondary membrane (as discussed in Section 6.3.3.7). At the tower shown in Figure 6-106 the anchor bolts were pulled out of the deck, which resulted in a progressive peeling of the fully adhered single-ply roof membrane. Tower collapse can also injure or kill people.

**Figure 6-106:**  
The collapse of the antenna tower at this school caused progressive peeling of the roof membrane. Also note that the exhaust fan blew off the curb, but the high parapet kept it from blowing off the roof. Hurricane Andrew (Florida, 1992)



See Sections 6.3.1.1 and 6.3.1.5 regarding site considerations for light fixture poles, power poles, and electrical and communications towers.

**Electrical service masts:** Service mast failure is typically caused by collapse of overhead power lines, which can be avoided by using underground service. Where overhead service is provided, it is recommended that the service mast not penetrate the roof. Otherwise, a downed service line could pull on the mast and rupture the roof membrane.

**Satellite dishes:** For the satellite dish shown in Figure 6-107, the dish mast was anchored to a large metal pan that rested on the roof membrane. CMU was placed on the pan to provide overturning resistance. This anchorage method should only be used where calculations demonstrate that it provides sufficient resistance. In this case, the wind approached the satellite dish in such a way that it experienced very little wind pressure. In hurricane-prone regions, use of this anchorage method is not recommended (see Figure 6-108).

**Lightning protection systems (LPS):** For attachment of building LPS located where the basic wind speed is in excess of 120 mph,<sup>36</sup> see the following section on attaching LPS in hurricane-prone regions.

<sup>36</sup> The 120-mph basic wind speed is based on ASCE 7-10, Risk Category III and IV buildings. If ASCE 7-05 or an earlier version is used, the equivalent wind speed trigger is 90 mph.





Figure 6-107: Common anchoring method for satellite dish. Estimated wind speed: 85–95 mph. Hurricane Ivan (Florida, 2004)



Figure 6-108: A satellite dish anchored similarly to that shown in Figure 6-107 was blown off this five-story building. Estimated wind speed: 140–160 mph. Hurricane Charley (Florida, 2004)

#### 6.3.4.4 Lightning Protection Systems in Hurricane-Prone Regions

LPSs frequently become disconnected from rooftops during hurricanes. Displaced LPS components can puncture and tear roof coverings, thus allowing water to leak into buildings (see Figures 6-109 and 6-110). Prolonged and repeated slashing of the roof membrane by loose conductors (“cables”) and puncturing by air terminals (“lightning rods”) can result in lifting and peeling of the membrane. Also, when displaced, the LPS is no longer capable of providing lightning protection in the vicinity of the displaced conductors and air terminals.

**Figure 6-109:**  
An air terminal (red arrow) debonded from the roof. Even though the school had a tough membrane (modified bitumen), the displaced air terminal punctured the membrane in two locations (blue arrows). Hurricane Charley (Florida, 2004)



**Figure 6-110:**  
View of an end of a conductor that became disconnected. Estimated wind speed: 130 mph. Hurricane Katrina (Mississippi, 2005)



Lightning protection standards such as NFPA 780 and UL 96A provide inadequate guidance for attaching LPSs to rooftops in hurricane-prone regions, as are those recommendations typically provided by LPS and roofing material manufacturers. LPS conductors are typically attached to the roof at 3-foot intervals. The conductors are flexible, and when they are exposed to high winds, the conductors exert dynamic loads on the conductor connectors (“clips”). Guidance for calculating the dynamic loads does not exist. LPS conductor connectors typically have prongs to anchor the conductor. When the connector is well-attached to the



roof surface, during high winds the conductor frequently bends back the malleable connector prongs (see Figure 6-111). Conductor connectors have also debonded from roof surfaces during high winds. Based on observations after Hurricane Ike and other hurricanes, it is apparent that pronged conductor connectors typically have not provided reliable attachment.



**Figure 6-111:** This conductor connector was adhered to the coping. The conductor deformed the connector prongs under wind pressure, and pulled away from the connector. Estimated wind speed: 130 mph. Hurricane Katrina (Mississippi, 2005)

To enhance the wind performance of LPS, the following are recommended:

**Parapet attachment:** When the parapet is 12 inches high or greater, it is recommended that the air terminal base plates and conductor connectors be mechanically attached with #12 screws that have minimum 1¼-inch embedment into the inside face of the parapet nailer and be properly sealed for watertight protection. Instead of conductor connectors that have prongs, it is recommended that mechanically attached looped connectors be installed (see Figure 6-112).

Figure 6-112:  
This conductor was  
attached to the  
coping with a looped  
connector. Estimated  
wind speed: 130 mph.  
Hurricane Katrina  
(Mississippi, 2005)



**Attachment to built-up, modified bitumen, and single-ply membranes:** For built-up and modified bitumen membranes, attach the air terminal base plates with asphalt roof cement. For single-ply membranes, attach the air terminal base plates with pourable sealer (of the type recommended by the membrane manufacturer).

In lieu of attaching conductors with conductor connectors, it is recommended that conductors be attached with strips of membrane installed by the roofing contractor. For built-up and modified bitumen membranes, use strips of modified bitumen cap sheet, approximately 9 inches wide at a minimum. If strips are torch-applied, avoid overheating the conductors. For single-ply membranes, use self-adhering flashing strips, approximately 9 inches wide at a minimum. Start the strips approximately 3 inches from either side of the air terminal base plates. Use strips that are approximately 3 feet long, separated by a gap of approximately 3 inches (see Figures 6-113 and 6-114).

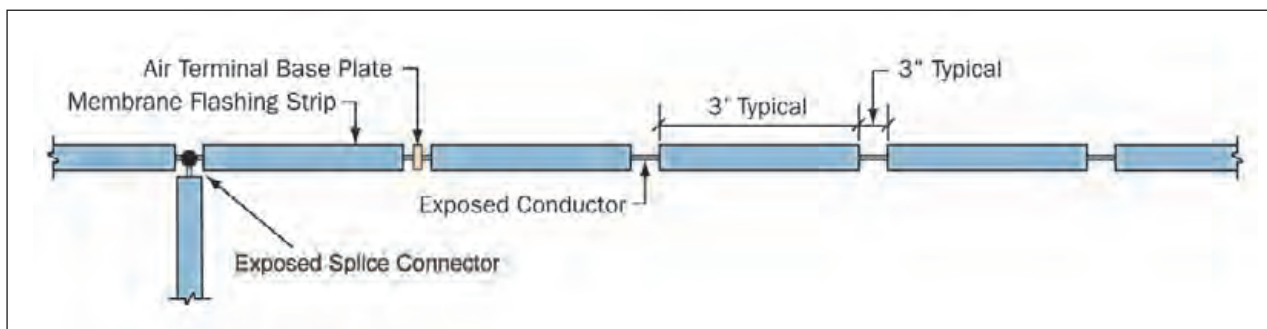

Figure 6-113: Plan showing conductor attachment



**Figure 6-114:**  
Use of intermittent  
membrane flashing  
strips to secure an LPS  
conductor, as illustrated  
in Figure 6-113

PHOTO COURTESY  
OF: MACGREGOR ASSOCIATES  
ARCHITECTS.

As an option to securing the conductors with stripping plies, conductor connectors that do not rely on prongs could be used (such as the one shown in Figure 6-115). However, the magnitude of the dynamic loads induced by the conductor is unknown, and there is a lack of data on the resistance provided by adhesively attached connectors. For this reason, attachment with stripping plies is the preferred option, because the plies shield the conductor from the wind. If adhesive-applied conductor connectors are used, it is recommended that they be spaced more closely than the 3-foot spacing required by NFPA 780 and UL 96A. Depending on wind loads, a spacing of 6 to 12 inches on center may be needed in the corner regions of the roof, with a spacing of 12 to 18 inches on center at roof perimeters (see ASCE 7 for the size of corner regions).

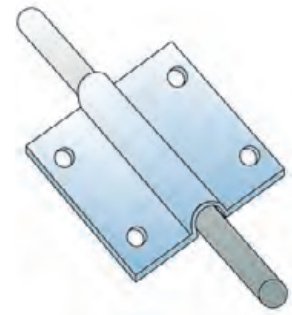

**Figure 6-115:**  
Adhesively attached  
conductor connector that  
does not use prongs

**Mechanically attached single-ply membranes:** It is recommended that conductors be placed parallel to, and within 8 inches of, membrane fastener rows. Where the conductor falls between or is perpendicular to membrane fastener rows, install an additional row of membrane fasteners where the conductor will be located, and install a membrane cover-strip over the membrane fasteners. Place the conductor over the cover-strip and secure the conductor as recommended above.

By following the above recommendations, additional rows of membrane fasteners (beyond those needed to attach the membrane) may be needed to accommodate the layout of the conductors. The additional membrane fasteners and cover-strip should be coordinated with, and installed by, the roofing contractor.

It is recommended that the building designer advise the building owner to have the LPS inspected each spring, to verify that connectors are still attached to the roof surface, that they still engage the conductors, and that the splice connectors are still secure. Inspections are also recommended after high-wind events.



**Standing seam metal roofs:** It is recommended that pre-manufactured, mechanically attached clips that are commonly used to attach various items to roof panels be used. After anchoring the clips to the panel ribs, the air terminal base plates and conductor connectors are anchored to the panel clips. In lieu of conductor connectors that have prongs, it is recommended that mechanically attached looped connectors be installed (see Figure 6-112).

**Conductor splice connectors:** In lieu of pronged splice connectors (see Figure 6-116), bolted splice connectors are recommended because they provide a more reliable connection (see Figure 6-117). It is recommended that strips of flashing membrane (as recommended above) be placed approximately 3 inches from either side of the splice connector to minimize conductor movement and to avoid the possibility of the conductors becoming disconnected. To allow for observation during maintenance inspections, do not cover the connectors.

**Figure 6-116:**  
If conductors detach from the roof, they are likely to pull out from pronged splice connectors. Estimated wind speed: 90–100 mph. Hurricane Charley (Florida, 2004)





**Figure 6-117:** Bolted splice connectors are recommended to prevent free ends of connectors from being whipped around by wind. Estimated wind speed: 130 mph. Hurricane Katrina (Mississippi, 2005)

### 6.3.5 Municipal Utilities In Hurricane-Prone Regions

Hurricanes typically disrupt municipal electrical service, and often they disrupt telephone (both cellular and land-line), water, and sewer services. These disruptions may last from several days to several weeks. Electrical power disruptions can be caused by damage to power generation stations and by damaged lines, such as major transmission lines and secondary feeders. Water disruptions can be caused by damage to water treatment or well facilities, lack of power for pumps or treatment facilities, or by broken water lines caused by uprooted trees. Sewer disruptions can be caused by damage to treatment facilities, lack of power for treatment facilities or lift stations, or broken sewer lines. Phone disruptions can be caused by damage at switching facilities and collapse of towers.

When a portion of a school is designed to function as a safe room, additional design criteria for backup or emergency power for the safe room portion of the school must meet additional performance criteria set forth in FEMA 361. In addition to backup power criteria, the safe room guidance identifies lighting, sewer, and water services.

For schools that will be used as hurricane evacuation shelters, provisions should be made to accommodate disruption of municipal utilities, as discussed in 6.3.5.1, 6.3.5.2, and 6.3.5.3.

For schools that will be used as recovery centers after a hurricane, it is recommended that the schools be equipped with an emergency generator or have pre-hurricane arrangements for delivery of a portable generator to the school prior to the recovery center becoming operational (see Figure 6-118). (Note: It could take a few or several days for a portable generator to be delivered.) If a portable generator rather than a permanent



on-site generator will be relied upon for power, it is recommended that an exterior box for single pole cable cam locking connectors be provided so that the portable generator can be quickly connected. The generator should be capable of providing power to items listed in Section 6.3.5.1. To provide for back-up water and sewer service, either the provisions discussed in 6.3.5.2 and 6.3.5.3, or pre-hurricane arrangements for delivery of water and portable toilets to the school prior to the recovery center becoming operational, are recommended.

**Figure 6-118:**  
In lieu of permanent on-site emergency generators, portable generators can be an economical way to provide electrical power to schools used as hurricane recovery centers. Estimated wind speed: 108 mph. Hurricane Ike (Texas, 2008)



For schools that will not be used as hurricane evacuation shelters or recovery centers, in lieu of spending money to incorporate provisions to accommodate disruption of municipal utilities, school re-opening could be delayed until municipal utilities are operational. (Note: In many instances, schools can't re-open for a couple of weeks after a hurricane because of various issues [such as debris removal from roads and school grounds] unrelated to utilities.)

### 6.3.5.1 Electrical Power

It is recommended that schools that will be used as hurricane evacuation shelters be provided with an emergency generator to supply power for lighting, exit signs, fire alarm system, fire sprinkler pump, public address system, and for mechanical ventilation. The emergency generator should be rated for prime power (continuous operation).

Generators should be placed inside wind-borne debris resistant buildings (see recommendations in Sections 6.3.2.2, 6.3.3.5, and 6.3.3.7) so

that they are not susceptible to damage from debris or tree fall. Locating generators outdoors or inside weak enclosures (see Figure 6-119) is not recommended.



**Figure 6-119:**  
The tree shown by the red line nearly fell on the emergency generator (red arrow). Estimated wind speed: 110 mph. Hurricane Ike (Texas, 2008)

It is recommended that wall louvers for generators be capable of resisting the test Missile E load specified in ASTM E 1996. Alternatively, wall louvers can be protected with a debris-resistant screen wall so that wind-borne debris is unable to penetrate the louvers and damage the generators. If a screen wall is used, it should be designed to allow adequate air flow to the generator in order to avoid overheating the generator.

Generators fired by natural gas are available. Use of natural gas alleviates various potential problems associated with on-site storage of diesel fuel (such as adequate quantity of fuel for prolonged outages). However, if the natural gas supply is shut down by the gas supplier, the school will be left without power.

It is recommended that sufficient on-site fuel storage be provided to allow the facility's emergency generator to operate at full capacity for a minimum of 72 hours (3 days). It is recommended that fuel storage tanks, piping, and pumps be placed inside wind-borne debris resistant buildings, or underground. If the site is susceptible to flooding, refer to Chapter 5 recommendations.

### 6.3.5.2 Water Service

It is recommended that schools that will be used as hurricane evacuation shelters be provided with an independent water supply via a well or on-site water storage for drinking water, fire sprinklers (if they

exist), and water-operated toilets. If water is needed for cooling towers, the independent water supply should be sized to accommodate the system.

It is recommended that pumps for wells or on-site storage be connected to an emergency power circuit, that a valve be provided on the municipal service line, and that on-site water treatment capability be provided where appropriate.

#### **6.3.5.3 Sewer Service**

It is recommended that schools that will be used as hurricane evacuation shelters be provided with portable chemical toilets or an alternative means of waste disposal, such as a temporary storage tank that can be pumped out by a local contractor. It is also recommended that back-flow preventors be provided in the sewage discharge lines.

### **6.3.6 Post-Design Considerations in Hurricane-Prone Regions**

In addition to adequate design, proper attention must be given to construction, post-occupancy inspections, and maintenance.

#### **6.3.6.1 Construction Contract Administration**

It is important for school districts in hurricane-prone regions to obtain the services of a professional contractor who will execute the work described in the contract documents in a diligent and technically proficient manner. The frequency of field observations and extent of special inspections and testing should be greater than those employed on schools that are not in hurricane-prone regions. The frequency of field observations and extent of special inspections and testing should be even greater for schools that will be used as hurricane evacuation shelters.

#### **6.3.6.2 Periodic Inspections, Maintenance, and Repair**

The recommendations given in Section 6.3.1.4 for post-occupancy and post-storm inspections, maintenance, and repair are crucial for schools in hurricane-prone regions. Failure of a building component that was not maintained properly, repaired, or replaced, can present a considerable risk of injury or death to occupants if the school is used as a hurricane evacuation shelter, and the continued operation of the facility can be jeopardized.

Refer to the two text boxes in Sections 6.3.4.2 that addresses inspection of flexible connectors at ducts and inspection of drains, scuppers, and gutters. Also refer to the text box in Section 6.3.4.4 that addresses inspection of lightning protection systems.

## 6.4 Remedial Work on Existing Facilities

**M**any existing schools need to strengthen their structural or building envelope components. The reasons for this are the deterioration that has occurred over time, or inadequate facility strength to resist current design level winds. It is recommended that school districts have a vulnerability assessment performed by a qualified architectural and engineering team. A vulnerability assessment should be performed for all facilities older than 5 years. An assessment is recommended for all facilities located in areas where the basic wind speed is greater than 120 mph<sup>37</sup> (even if the facility is younger than 5 years—see Figure 6-120). It is particularly important to perform vulnerability assessments on schools located in hurricane-prone and tornado-prone regions.



**Figure 6-120:** The roof and a portion of the EIFS on this 5-year-old building blew off. Water leaked into the floor below. The floor was taken out of service for more than a month. Estimated wind speed: 130 mph. Hurricane Katrina (Mississippi, 2005)

Components that typically make buildings constructed before the early 1990s vulnerable to high winds are weak non-load-bearing masonry walls, poorly connected precast concrete panels, long-span roof structures with limited uplift resistance, inadequately connected roof decks, weak glass curtain walls, building envelope, and exterior-mounted equipment. Although the technical solutions to these problems are not difficult, the cost of the remedial work is typically quite high. If funds are not available for strengthening or replacement, it is important to minimize the risk of injury and death by evacuating areas adjacent to

<sup>37</sup> The 120-mph basic wind speed is based on ASCE 7-10, Risk Category III and IV buildings. If ASCE 7-05 or an earlier version is used, the equivalent wind speed trigger is 90 mph.



weak non-load-bearing walls, weak glass curtain walls, and areas below long-span roof structures when winds above 60 mph are forecast.

As a result of building code changes and heightened awareness, some of the common building vulnerabilities have generally been eliminated for facilities constructed in the mid-1990s or later. Components that typically remain vulnerable to high winds are the building envelope and exterior-mounted mechanical, electrical, and communications equipment. Many failures can be averted by identifying weaknesses and correcting them.

By performing a vulnerability assessment, items that need to be strengthened or replaced can be identified and prioritized. A proactive approach in mitigating weaknesses can save significant sums of money and decrease disruption or total breakdown in school operations after a storm. For example, a vulnerability assessment on a building such as

Before beginning remedial work, it is necessary to understand all significant aspects of the vulnerability of a school with respect to wind and wind-driven rain. If funds are not available to correct all identified deficiencies, the work should be systematically prioritized so that the items of greatest need are corrected first. Mitigation efforts can be very ineffective if they do not address all items that are likely to fail.

that shown in Figure 6-120 may identify weakness of the roof membrane and/or EIFS. Replacing weak components before a storm is much cheaper than replacing them and repairing consequential damages after a storm, and proactive work avoids the loss of use while repairs are made.

If budget constraints prohibit timely evaluation of all schools in the district, then facility evaluation should be prioritized, commensurate with district's needs and the perceived vulnerabilities of the facilities. For example, schools that will be used as hurricane evacuation shelters, recovery centers after a hurricane, and facilities constructed before the early 1990s would normally be evaluated first. Upon completion of the evaluations of the district's facilities, the order in which remedial work will be scheduled should be prioritized.

For those schools that will be used as hurricane evacuation shelters or as recovery centers after a hurricane, the vulnerability assessment should also evaluate the facility's capability of coping with loss of municipal utilities (i.e., electrical power, water, sewer, and communications).

A comprehensive guide for performing a vulnerability assessment and for remedial work on existing facilities is beyond the scope of this manual. However, the checklist in Section 6.6 provides a guide for vulnerability assessment, and the remainder of this Section provides examples of mitigation measures that are often applicable.



### 6.4.1 Structural Systems

As discussed in Section 6.1.4.1, roof decks on many facilities designed prior to the 1982 edition of the SBC and UBC and the 1987 edition of the NBC are very susceptible to failure. Poorly attached decks that are not upgraded are susceptible to blow-off, as shown in Figure 6-121. Decks constructed of cementitious wood-fiber, gypsum, and lightweight insulating concrete over form boards were commonly used on schools built in the 1950s and 1960s. In that era, these types of decks, as well as precast concrete decks, typically had very limited uplift resistance due to weak connections to the support structure. Steel deck attachment is frequently not adequate because of an inadequate number of welds, or welds of poor quality. Older buildings with overhangs are particularly susceptible to blow-off, as shown in Figure 6-121, because older codes provided inadequate uplift criteria.



**Figure 6-121**  
The cementitious wood-fiber deck panels blew off of much of the overhang at this school. Deck panel failure resulted in lifting and peeling of the roof system over a large area, exposure of the decking in the area shown by the blue arrows, and extensive interior water infiltration. Estimated wind speed: 105–115 mph. Hurricane Ivan (Florida, 2004)

PHOTO COURTESY OF RICOWI, INC. PHOTO #:PD02-047 4-08-4. PHOTOGRAPHER: PHIL DREGGER, TECHNICAL ROOF SERVICES, INC.

A vulnerability assessment of the roof deck should include evaluating the existing deck attachment, spot checking the structural integrity of the deck (including the underside, if possible), and evaluating the integrity of the beams/joists. If the deck attachment is significantly overstressed under current design wind conditions or the deck integrity is compromised, the deck should be replaced or strengthened as needed. The evaluation should be conducted by an investigator experienced with the type of deck used on the building.

The vulnerability assessment should also include evaluating the structural integrity of canopies, for as shown in Figure 6-41, these elements often lack sufficient wind resistance.

If a low-slope roof is converted to a steep-slope roof, the new support structure should be engineered and constructed to resist the wind loads and avoid the kind of damage shown in Figure 6-122.

**Figure 6-122:**  
The steel truss superstructure installed on this school as part of a steep-slope conversion blew away because of inadequate attachment. Hurricane Marilyn (U.S. Virgin Islands, 1995)



### 6.4.2 Building Envelope

Because of the lack of field diagnostic equipment and test methods, it is quite difficult to accurately assess the wind and wind-driven rain vulnerability of the building envelope and rooftop equipment. Review of existing drawings (if available) often times reveal vulnerabilities. However, it is frequently necessary to perform selective destructive observation as part of the assessment. A successful assessment is dependent upon the school district budgeting sufficient funds for the assessment and upon the expertise, experience, and judgment of design professionals performing the assessment. The following recommendations apply to building envelope components of existing schools.

### 6.4.2.1 Windows and Skylights

Windows in older facilities may possess inadequate resistance to wind pressure. Window failures are typically caused by wind-borne debris, however, glazing or window frames may fail as a result of wind pressure (see Figure 6-123). Failure can be caused by inadequate resistance of the glazing, inadequate anchorage of the glazing to the frame, failure of the frame itself, or inadequate attachment of the frame to the wall. For older windows that are too weak to resist the current design pressures, window assembly replacement is recommended.



**Figure 6-123:** Wind pressure caused the window frames on the upper floors to fail (red arrow). Estimated wind speed: 130 mph. Hurricane Katrina (Mississippi, 2005)

Some older window assemblies have sufficient strength to resist the design pressure, but are inadequate to resist wind-driven rain. If the lack of water resistance is due to worn glazing gaskets or sealants, replacing the gaskets or sealant may be viable. In other situations, replacing the existing assemblies with new, higher-performance assemblies may be necessary. On-site testing in accordance with ASTM E 1105 can be used to evaluate wind-driven rain resistance of suspect windows (see Figure 6-124). (Note: Shutters placed over windows to provide wind-borne debris protection should not be relied upon to protect against wind-driven rain. If existing windows are susceptible to debris and leakage, the windows should be replaced with new assemblies.)



**Figure 6-124:**  
On-site water-spray testing in accordance with ASTM E 1105 can be used to evaluate wind-driven rain resistance. Older window assemblies such as the ones at this school are often quite susceptible to leakage. Estimated wind speed: 125 mph. Hurricane Katrina (Mississippi, 2005)



It is recommended that all non-impact-resistant, exterior glazing located in hurricane-prone regions (with a basic wind speed of 135 mph or greater)<sup>38</sup> be replaced with impact-resistant glazing or be protected with shutters, as discussed in Section 6.3.3.3. Shutters are typically a more economical approach for existing facilities. There are a variety of shutter types, all illustrated by Figures 6-125 to 6-128. Accordion shutters are permanently attached to the wall (Figure 6-125). When a hurricane is forecast, the shutters are pulled together and latched into place. Panel shutters (Figures 6-126 and 6-127) are made of metal or polycarbonate. When a hurricane is forecast, the shutters are taken from storage and inserted into metal tracks that are permanently mounted to the wall above and below the window frame as shown in Figure 6-126 (or fastened to the building as shown in Figure 6-127). The panels are locked into the frame with wing nuts or clips. Track designs that have permanently mounted studs for the nuts have been shown to be more reliable than track designs using studs that slide into the track. A disadvantage of panel shutters is the need for storage space. Roll-down shutters (Figure 6-128) can be motorized or pulled down manually. Motorized shutters are available with toggles that allow the shutter to be manually raised. The advantage of being able to open the shutter without electrical power is that if water leaked into the building and if the door or window protected by the shutter is operable, the shutter can be manually raised in order to facilitate venting (drying of the interior).

<sup>38</sup> The 135-mph basic wind speed is based on ASCE 7-10, Risk Category III and IV buildings. If ASCE 7-05 or an earlier version is used, the equivalent wind speed trigger is 100 mph.



Figure 6-125:  
This school has  
accordion shutters.  
Estimated wind  
speed: 105–115 mph.  
Hurricane Ivan (Florida,  
2004)



Figure 6-126:  
A metal panel shutter.  
Hurricane Georges  
(Puerto Rico, 1998)



**Figure 6-127:**  
Polycarbonate shutters were temporary screwed to the doors and wall adjacent to the window opening. An advantage of polycarbonate is its translucence, which allows daylight to enter the building without removing the shutters. Hurricane Francis (Florida, 2004)



**Figure 6-128:**  
This school has roll-down shutters. The toggle in the red circle allows the shutter to be manually raised. Estimated wind speed: 130–140 mph. Hurricane Charley (Florida, 2004)



Deploying accordion or panel shutters a few stories above grade is expensive. Although motorized shutters have greater initial cost, their operational cost should be lower. Other options for providing missile protection on upper levels include replacing the existing assemblies with laminated glass assemblies, or installing permanent impact resistant screens. Engineered films are also available for application to the interior of the glass. The film needs to be anchored to the frame, and the frame needs to be adequately anchored to the wall. The film degrades over time and requires replacement (approximately every decade). Use of laminated glass or shutters/screens is recommended in lieu of engineered films.

#### 6.4.2.2 Non-Load-Bearing Walls, Wall Coverings, and Soffits

Non-load-bearing walls, wall coverings, and soffits on existing schools should be carefully examined and evaluated for wind and wind-driven rain resistance.

If the parapet is constructed of masonry, it is recommended that its wind resistance be evaluated and strengthened if found to be inadequate. The masonry parapet shown in Figure 6-129 fell onto the roof. Had it fallen in the other direction, it would have blocked the entry and would have had the potential to cause injury.

To identify weak EIFS systems so that corrective action can be taken to avoid the type of damage shown in Figures 6-61 and 6-62, on-site testing in accordance with ASTM E 2359 can be conducted. (Note: This test method is not capable of evaluating the wind resistance of the wall framing.)



Figure 6-129:  
Collapsed unreinforced  
masonry parapet.  
Greensburg Tornado  
(Kansas, 2007)

### 6.4.2.3 Roof Coverings

On-site testing in accordance with ASTM E 907 can be used to evaluate the uplift resistance of roof systems that have fully adhered membranes (see Figure 6-130). (Note: This test method is not capable of evaluating the uplift resistance of the roof deck.)

**Figure 6-130:**  
View of a 5-foot by 5-foot negative pressure chamber used to evaluate roof system uplift resistance.



For roofs with weak metal edge flashing or coping attachment, face-attachment of the edge flashing/coping (as shown in Figure 6-73) is a cost-effective approach to greatly improve the wind-resistance of the roof system. To improve the wind resistance of weak gutters, a cost-effective approach is to install straps as shown in Figure 6-77. Alternatively, if the gutter bracket attachment is sufficient to resist rotational force (as discussed in Section 6.3.3.6), but the gutter is not anchored to the brackets, fasteners can be installed to anchor the gutter to the bracket as shown in Figure 6-76.

The vulnerability assessment of roofs ballasted with aggregate, pavers, or cementitious-coated insulation boards, should determine whether the ballast complies with ANSI/SPRI RP-4. Corrective action is recommended for non-compliant, roof coverings. It is recommended that roof coverings with aggregate surfacing, lightweight pavers, or cementitious-coated insulation boards on buildings located in hurricane-prone regions be replaced to avoid blow-off (see Figures 6-8, 6-13, 6-23, and 6-53).



When planning the replacement of a roof covering, it is recommended that all existing roof covering be removed down to the deck rather than simply re-covering the roof. Tearing off the covering provides an opportunity to evaluate the structural integrity of the deck and correct deck attachment and other problems. For example, if a roof deck was deteriorated due to roof leakage (see Figure 6-131), the deterioration would likely not be identified if the roof was simply re-covered. By tearing off down to the deck, deteriorated decking like that shown in Figure 6-131 can be found and replaced. In addition, it is recommended that the attachment of the wood nailers at the top of parapets and roof edges be evaluated and strengthened where needed, to avoid blow-off and progressive lifting and peeling of the new roof membrane (see Figure 6-132).



**Figure 6-131:**  
The built-up roof on this school was blown off after a few of the rotted wood planks detached from the joists. Estimated wind speed: 120 mph. Hurricane Katrina (Mississippi, 2005)



**Figure 6-132:**  
The nailer (red arrow) blew off an upper roof and landed on the roof below. The nailer was anchored to a brick wall. Some of the anchors pulled out of the brick, and some of the bricks blew away with the nailer. Estimated wind speed: 105–115 mph. Hurricane Ivan (Florida), 2004



If the roof has a parapet, it is recommended that the inside of the parapet be properly prepared to receive the new base flashing. In many instances, it is prudent to re-skin the parapet with sheathing to provide a suitable substrate. Base flashing should not be applied directly to brick parapets because they have irregular surfaces that inhibit good bonding of the base flashing to the brick (see Figure 6-133). Also, if moisture drives into the wall from the exterior side of the parapet with base flashing attached directly to brick, the base flashing can inhibit drying of the wall. Therefore, rather than totally sealing the parapet with membrane base flashing, the upper portion of the brick can be protected by metal panels (as shown in Figure 6-88), which permits drying of the brick.

**Figure 6-133:**  
Failed base flashing adhered directly to the brick parapet. Estimated wind speed: 105 mph. Hurricane Katrina (Louisiana, 2005)





When reroofing a steep-sloped roof, if it does not have a continuous ridge vent, but one will be installed as part of the reroofing work, the following are recommended:

- If the decking is intended to act as a diaphragm and the diaphragm loads are high, the typical technique of cutting a slot through the decking (as shown in Figure 6-134) can compromise the integrity of the diaphragm by interrupting the transfer of diaphragm load from one side of the ridge to the other. For guidance on cutting vent openings that do not compromise diaphragm integrity, see Section 12.7.6 in FEMA 55. Note: An updated version of FEMA 55 is expected to be released in 2011.
- To prevent weakening of joists or trusses (as occurred at Figure 6-134), prior to slotting the deck, the depth of the saw should be adjusted so that the blade is only slightly below the bottom of the deck.



**Figure 6-134:** During a reroofing project a slot was cut in the plywood deck in order to allow air to flow from the attic to a new continuous ridge vent. The cutting depth of the saw was not adjusted for the thickness of the deck. The top 1½ inch of each truss and a portion of the metal nailing plate was inadvertently cut.

### 6.4.3 Exterior-Mounted Equipment

Exterior-mounted equipment on existing schools should be carefully examined and evaluated.

#### 6.4.3.1 HVAC Units, Condensers, Fans, Exhaust Stacks, and Ductwork

Where HVAC units are inadequately anchored to their curbs, or where the curb is inadequately attached, cables with turnbuckles should be attached to pipe anchors attached to the deck (see Figure 6-135). The pipe anchors should be stiff so that the top of the anchor is not pulled towards the unit by the cable (otherwise, the unit may lift and shift off the curb).

**Figure 6-135:**  
To strengthen attachment of this HVAC unit, robust pipe anchors were attached to the deck and cables with turnbuckles installed.



If HVAC units have inadequately attached sheet metal hoods (see Figure 6-136), sheet metal straps can be economically installed between the top of the hood and the side of the unit. Equipment access panels may also need to be modified to resist wind loads as discussed in Section 6.3.4.1. Besides avoiding damage to the unit, these types of retrofits can prevent blown-off hoods and panels from causing injury and damaging the roof membrane or other building components.

**Figure 6-136:**  
At this school, the hood on this HVAC unit was inadequately attached. A strap between the hood and unit can be economically installed to avoid this problem. Estimated wind speed: 110 mph. Hurricane Ike (Texas, 2008)



Where condensers are mounted to curbs that are adequately anchored to the deck, straps can be installed as shown in Figure 6-95 if the condenser attachment is inadequate. If condensers are mounted on sleepers (see Figure 6-137), then the condensers should be re-mounted and anchored to curbs or stands that are anchored to the roof deck.

If exhaust stacks such as those shown in Figure 6-137 are inadequately anchored, guys attached to pipe anchors such as those shown in Figure 6-135 should be installed. To avoid blow-off of rain caps as shown in Figure 6-137, additional straps or screws may need to be installed.



**Figure 6-137:** These condensers were simply mounted on wood sleepers that rested on the roof surface. Note the damaged exhaust stacks and missing rain caps (red oval). Estimated wind speed: 105 mph. Hurricane Katrina (Mississippi, 2005)

To avoid blow-off of fan cowlings, installation of cables is recommended as discussed in Section 6.3.4.1.

If rooftop ductwork exists, its wind resistance should be carefully evaluated. As shown in Figure 6-138, blown-off ducts can allow a substantial amount of rain to enter a building.

Fastening rooftop equipment to curbs, as discussed in Section 6.3.4.1, is a cost-effective approach to minimize wind-induced problems.



**Figure 6-138:**  
Two large openings (red rectangle and inset) through the roof were left after the ductwork blew away. Estimated wind speed: 130 mph. Hurricane Katrina (Mississippi, 2005)

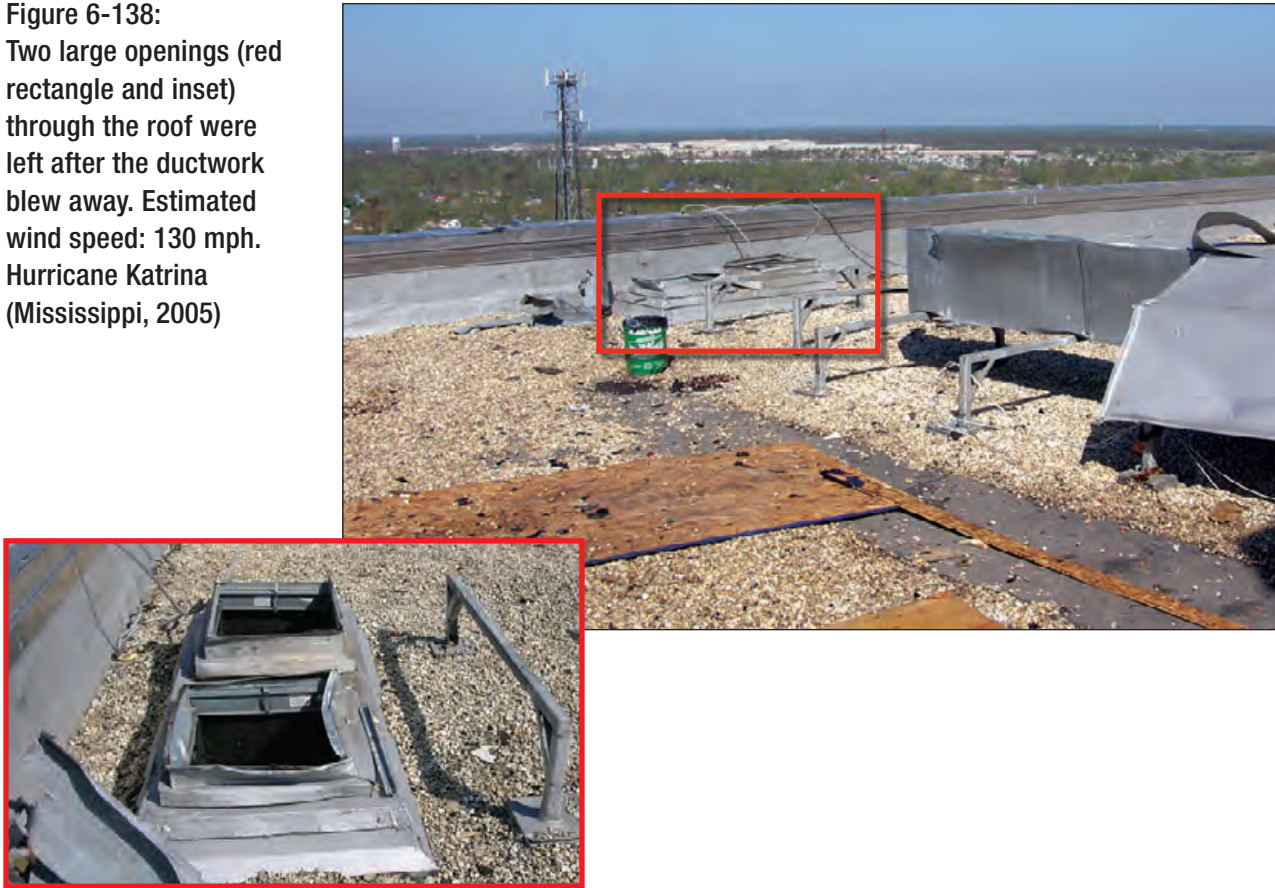

#### 6.4.3.2 Antenna (Communications Mast)

Antenna collapse is very common. Besides loss of communications, collapsed masts can puncture roof membranes or cause other building damage as shown in Figure 6-139. This case also demonstrates the benefits of a high parapet. Although the roof still experienced high winds that blew off this penthouse door, the parapet prevented the door from blowing off the roof (red arrow in Figure 6-139).

#### 6.4.3.3 Lightning Protection Systems

Adhesively attached conductor connectors and pronged splice connectors typically have not provided reliable attachment during hurricanes. To provide more reliable attachment for LPSs located in hurricane-prone regions where the basic wind speed is 135 mph<sup>39</sup> or greater, it is recommended that attachment modifications based on the guidance given in Section 6.3.4.4 be used.

<sup>39</sup> The 135-mph basic wind speed is based on ASCE 7-10, Risk Category III and IV buildings. If ASCE 7-05 or an earlier version is used, the equivalent wind speed trigger is 100 mph.



**Figure 6-139:**  
The antenna collapsed and was whipped back and forth across the roof membrane. Hurricane Andrew (Florida, 1992)

## 6.5 Occupant Protection Best Practices in Tornado- and Hurricane-Prone Regions

**S**trong and violent tornadoes may reach wind speeds substantially greater than those recorded in the strongest hurricanes. The wind pressures that these tornadoes can exert on a building are tremendous, and far exceed the minimum pressures derived from building codes. The same can be said, but to a lesser extent for Category 4 and 5 hurricanes that may make landfall with wind speeds that exceed the basic (design) wind speed by 50 mph or more.

Strong and violent tornadoes can generate very powerful missiles. Experience shows that large and heavy objects, including vehicles (see Figure 6-140), can be hurled into buildings at high speeds. The missile sticking out of the school roof in the foreground of Figure 6-141 is a double 2-inch by 6-inch wood member. The portion sticking out of the roof is 13 feet long. It penetrated a ballasted ethylene propylene diene monomer (EPDM) membrane, approximately 3 inches of polyisocyanurate roof insulation, and the steel roof deck. The missile lying on the roof just beyond is a 2-inch by 10-inch by 16-foot long wood member.

**Terrorist threat:** If it is desired to incorporate a tornado safe room, and if it is also desired for the safe room to provide protection from terrorism, refer to FEMA 428 and 453 for additional shelter enhancements.



**Figure 6-140:**  
**Greensburg Tornado**  
**(Kansas, 2007)**



**Figure 6-141:**  
**A violent tornado**  
**showered the roof with**  
**missiles (Oklahoma,**  
**1999)**



For schools located in tornado-prone regions (as defined in the text box on the following page) and for schools that will be used for hurricane shelters, it is recommended that a safe room be incorporated within the school to provide occupant protection. For safe room design, see FEMA 361.

Note: The 2009 edition of the IBC references ICC 500 for the design and construction of hurricane and tornado shelters. However, while ICC 500 specifies shelter criteria, it does not require shelters. ICC 500 is available to those who voluntarily desire to use it and to jurisdictions for adoption. FEMA 361 references much of the ICC 500 Standard.

In this manual, the term “**tornado-prone regions**” refers to those areas of the United States where the number of recorded EF3, EF4, and EF5 tornadoes per 2,470 square miles is 5 or greater per year (see Figure 6-141). However, a school district may decide to use other frequency values (e.g., 1 or greater, 11 or greater, or greater than 15) in defining whether a school is in a tornado-prone area. In this manual, a tornado safe room is recommended for all schools in tornado-prone regions.

Where the frequency value is 1 or greater, and the school does not have a tornado safe room or shelter, the best available refuge areas should be identified, as discussed at the end of this Section.

### Existing Schools without Tornado Shelters

Where the number of recorded EF3, EF4, and EF5 tornadoes per 2,470 square miles is one or greater (see Figure 6-142), the best available refuge areas should be identified if the school does not have a tornado safe room. FEMA 431 provides useful information for building owners, architects, and engineers who perform evaluations of existing facilities.

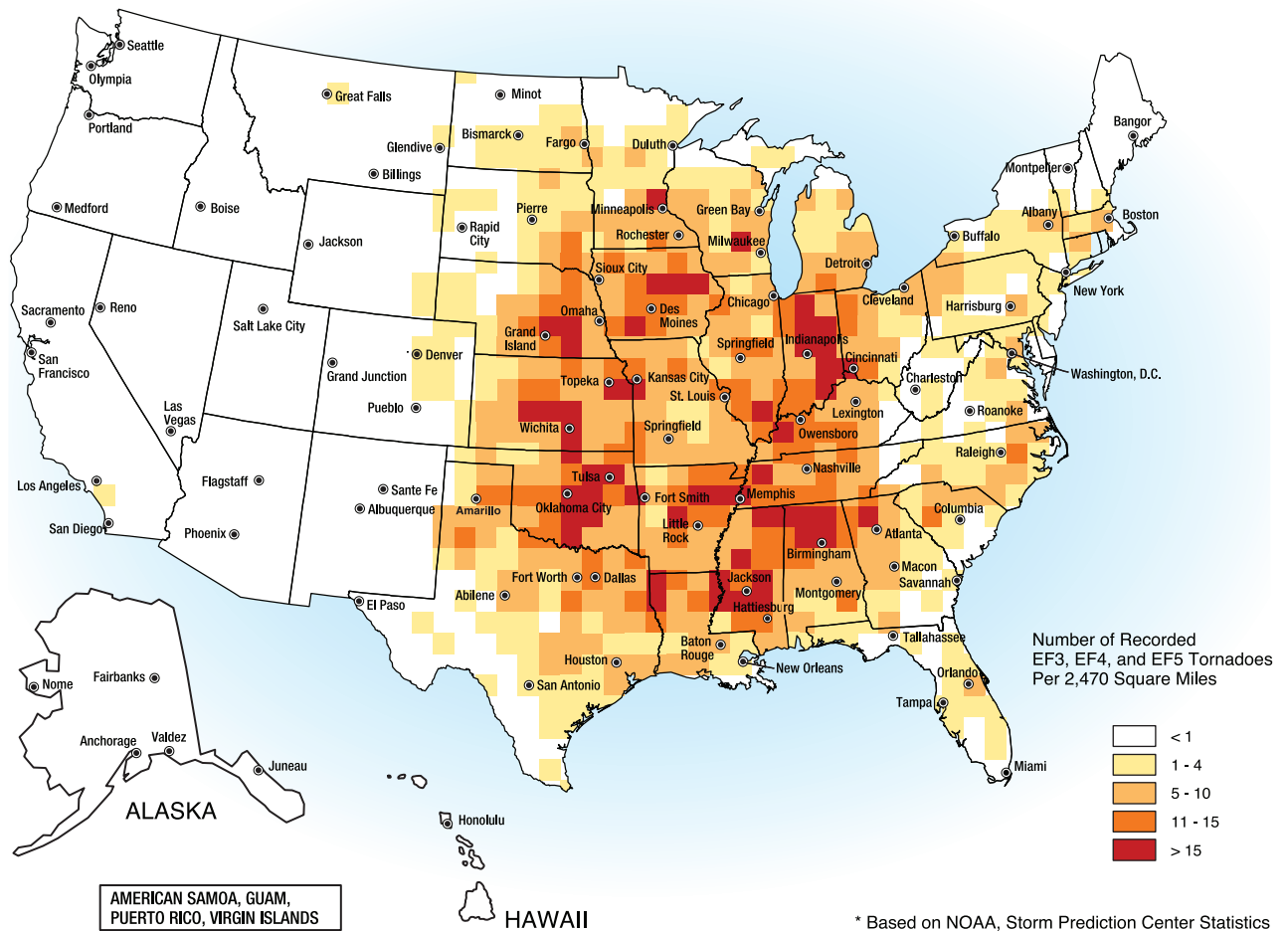

Figure 6-142: Frequency of recorded EF3, EF4, and EF5 tornadoes (1950–2006)

“**Safe room**” and “**shelter**” are two terms that have been used interchangeably in past publications, guidance documents, and other shelter-related materials. However, with the release of the ICC 500 standard, there is a need to identify or describe shelters that meet the FEMA criteria that provide near-absolute life-safety protection and those that meet the ICC 500 standard (which is simply life-safety protection). To help clarify the difference between shelters designed to the ICC 500 standard and the FEMA 361 guidance, FEMA 361 refers to all shelters constructed to meet the FEMA criteria as safe rooms. These two documents are quite similar and both utilize the same wind speed maps to define the tornado and hurricane hazards. Further, all safe room criteria in FEMA 361 meet the shelter requirements of the ICC 500. However, a few design and performance criteria in FEMA 361 are more restrictive than some of the requirements found in the ICC 500.

#### **Hurricane safe room and evacuation shelters:**

In addition to providing criteria for the design and construction of tornado safe rooms, FEMA 361 provides criteria for hurricane safe rooms. Because of differences between wind and wind-borne debris loads induced by tornadoes versus hurricanes, and because of the time difference that the safe room is occupied during these storms, some of the hurricane safe room criteria are different. It is recommended that schools that will be used as hurricane evacuation shelters be designed and constructed in accordance with hurricane safe room guidance given in FEMA 361. In addition, see the recommendations in Section 6.3.5 regarding electrical power, water, and sewer.

Publication 4496 by the American Red Cross (ARC, 2002) provides information regarding assessing existing buildings for use as hurricane evacuation shelters. Unless a school has been specifically designed for use as a shelter, it should only be used as a last resort and only if the school meets the criteria given in ARC 4496.

To minimize casualties in schools, it is very important that the best available refuge areas be identified by a qualified architect or engineer.<sup>40</sup> Once identified, those areas need to be clearly marked so that occupants can reach the refuge areas without delay. Building occupants should not wait for the arrival of a tornado to try to find the best available refuge area in a particular facility; by that time, it will be too late. If refuge areas have not been identified beforehand, occupants will take cover wherever they can, frequently in very dangerous places. Corridors and other refuge areas sometimes provide protection, but they can also be death traps. The school shown in Figure 6-143 did not have a safe room. However, it did have a best available refuge area, which was occupied during a tornado. Unfortunately, collapsing occurred and eight students died.

Retrofitting a shelter space inside an existing school can be very expensive. An economical alternative is an addition that can function as a safe room as well as serve another purpose. This approach works well for many schools. For very large schools, constructing two or more safe room additions should be considered in order to reduce the time it takes to reach the safe room (often there is ample warning time, but sometimes an approaching tornado is not noticed until a few minutes before it strikes).

<sup>40</sup> The occupants of a “best available refuge area” are still vulnerable to death and injury if the refuge area was not specifically designed as a tornado safe room.





Figure 6-143 :  
Unreinforced masonry  
walls and hollow-core  
concrete roof planks  
collapsed. Enterprise  
Tornado (Alabama, 2007)

**Portable Classrooms:** Portable classrooms should not be occupied during times when a tornado watch has been issued by the National Weather Service (a watch means that conditions are favorable for tornado development). Do not wait for issuance of a tornado warning (i.e., a tornado has been spotted) by the National Weather Service to seek refuge in the main school building. If a tornado is nearby, students could be caught outdoors.

## 6.6 Checklist For Building Vulnerability of Schools Exposed to High Winds

The Building Vulnerability Assessment Checklist (Table 6-2) is a tool that can help in assessing the vulnerability of various building components during the preliminary design of a new building, or the rehabilitation of an existing building. In addition to examining design issues that affect vulnerability to high winds, the checklist also examines the potential adverse effects on the functionality of the critical and emergency systems upon which most schools depend. The checklist is organized into separate sections, so that each section can be assigned to a subject expert for greater accuracy of the examination. The results should be integrated into a master vulnerability assessment to guide the design process and the choice of appropriate mitigation measures.

Table 6-2: Checklist for building vulnerability of schools exposed to high winds

Vulnerability Sections	Guidance	Observations
<b>General</b>		
What is the age of the facility, and what building code and edition was used for the design of the building?	<p>Substantial wind load improvements were made to the model building codes in the 1980s. Many buildings constructed prior to these improvements have structural vulnerabilities. Since the 1990s, several additional changes have been made, the majority of which pertain to the building envelope.</p> <p>Older buildings, not designed and constructed in accordance with the practices developed since the early 1990s, are generally more susceptible to damage than newer buildings.</p>	
Is the school older than 5 years, or is it located in a zone with basic wind speed greater than 120 mph?†	In either case, perform a vulnerability assessment with life-safety issues as the first priority, and property damage and interruption of service as the second priority.	
<b>Site</b>		
What is the design wind speed at the site? Are there topographic features that will result in wind speed-up?	ASCE 7	
What is the wind exposure on site?	Avoid selecting sites in Exposure D, and avoid escarpments and hills.	
Are there trees or towers on site?	Avoid trees and towers near the facility. If the site is in a hurricane-prone region, avoid trees and towers near primary access roads.	
Road access	Provide two separate means of access.	
Is the site in a hurricane-prone region?	ASCE 7. If yes, follow hurricane-resistant design guidance.	
If in a hurricane-prone region, are there aggregate-surfaced roofs within 1,500 feet of the facility?	Remove aggregate from existing roofs. If the buildings with aggregate are owned by other parties, attempt to negotiate the removal of the aggregate.	
<b>Architectural</b>		
Will the facility be used as a shelter?	If yes, refer to FEMA 361.	
Are there interior non-load-bearing masonry walls?	Design for wind load. See Section 6.3.3.4.	
Are there multiple buildings on site in a hurricane-prone region?	Provide enclosed walkways between buildings that will be occupied during a hurricane.	
<b>Structural Systems</b>		
<b>Section 6.3.2</b>		
Is a pre-engineered building being considered?	If yes, ensure the structure is not vulnerable to progressive collapse. If a pre-engineered building exists, evaluate to determine if it is vulnerable to progressive collapse.	

† The 120-mph basic wind speed is based on ASCE 7-10, Risk Category III and IV buildings. If ASCE 7-05 or an earlier version is used, the equivalent wind speed trigger is 90 mph.



Table 6-2: Checklist for building vulnerability of schools exposed to high winds

Vulnerability Sections	Guidance	Observations
<b>Structural Systems (cont.)</b>		
<b>Section 6.3.2</b>		
<b>Is precast concrete being considered?</b>	If yes, design the connections to resist wind loads. If precast concrete elements exist, verify that the connections are adequate to resist the wind loads.	
<b>Are exterior load-bearing walls being considered?</b>	If yes, design as MWFRS and C&C.	
<b>Is an FM Global-rated roof assembly specified?</b>	If yes, comply with FM Global deck criteria.	
<b>Is there a covered walkway or canopy?</b>	If yes, use “free roof” pressure coefficients from ASCE 7. Canopy decks and canopy framing members on older buildings often have inadequate wind resistance. Wind-borne debris from canopies can damage adjacent buildings and cause injury.	
<b>Is the site in a hurricane-prone region?</b>	A reinforced cast-in-place concrete structural system, and reinforced concrete or fully grouted and reinforced CMU walls, is recommended.	
<b>Is the site in a tornado-prone region?</b>	If yes, provide occupant protection. See FEMA 361. For existing schools that do not have safe rooms, see FEMA 431.	
<b>Do portions of the existing facility have long-span roof structures (e.g., a gymnasium)?</b>	Evaluate structural strength, since older long-span structures often have limited uplift resistance.	
<b>Is there adequate uplift resistance of the existing roof deck and deck support structure?</b>	The 1979 (and earlier) SBC and UBC, and 1984 (and earlier) BOCA/NBC, did not prescribe increased wind loads at roof perimeters and corners. Decks (except cast-in-place concrete) and deck support structures designed in accordance with these older codes are quite vulnerable. The strengthening of the deck attachment and deck support structure is recommended for older buildings.	
<b>Are there existing roof overhangs that cantilever more than 2 feet?</b>	Overhangs on older buildings often have inadequate uplift resistance.	
<b>Building Envelope</b>		
<b>Section 6.3.3</b>		
<b>Exterior doors, walls, roof systems, windows, and skylights.</b>	Select materials and systems, and detail, to resist wind and wind-driven rain.	
<b>Are soffits considered for the building?</b>	Design to resist wind and wind-driven water infiltration. If there are existing soffits, evaluate their wind and wind-driven rain resistance. If the soffit is the only element preventing wind-driven rain from being blown into an attic space, consider strengthening the soffit.	
<b>Are there elevator penthouses on the roof?</b>	Design to prevent water infiltration at walls, roof, and mechanical penetrations.	
<b>Is a low-slope roof considered on a site in a hurricane-prone region?</b>	A minimum 3-foot parapet is recommended on low-slope roofs.	

Table 6-2: Checklist for building vulnerability of schools exposed to high winds

Vulnerability Sections	Guidance	Observations
<b>Building Envelope (cont.)</b>		
<b>Section 6.3.3</b>		
Are there existing sectional or rolling doors?	Older doors often lack sufficient wind resistance.	
Does the existing building have large windows or curtain walls?	If an older building, evaluate their wind resistance.	
Does the existing building have exterior glazing (windows, glazed doors, or skylights)?	If the building is in a hurricane-prone region, replace with impact-resistant glazing, or protect with shutters.	
Does the existing building have operable windows?	If an older building, evaluate its wind-driven rain resistance via ASTM E 1105.	
Are there existing exterior non-load-bearing masonry walls?	If the building is in a hurricane- or tornado-prone region, strengthen or replace.	
Are there existing brick veneer, EIFS, or stucco exterior coverings?	If the building is in a hurricane-prone region, evaluate attachments. To evaluate wind resistance of EIFS, see ASTM E 2359.	
Are existing exterior walls resistant to wind-borne debris?	If the building will be used as a hurricane evacuation shelter, but was not designed and constructed in accordance with FEMA 361, consider enhancing debris resistance.	
Does the existing roof have a fully adhered membrane?	To evaluate uplift resistance, see ASTM E 907.	
Are there existing ballasted single-ply roof membranes?	Determine if they are in compliance with ANSI/SPRI RP-4. If non-compliant, take corrective action.	
Does the existing roof have aggregate surfacing, lightweight pavers, or cementitious-coated insulation boards?	If the building is in a hurricane-prone region, replace the roof covering to avoid blow-off.	
Does the existing roof have edge flashing, coping, or gutters?	Evaluate the adequacy of the attachment.	
Does the existing roof system incorporate a secondary membrane?	If not, and if the building is in a hurricane-prone region, reroof and incorporate a secondary membrane into the new system.	
Does the existing building have a brittle roof covering, such as slate or tile?	If the building is in a hurricane-prone region, consider replacing with a non-brittle covering, particularly if the building will be used as a hurricane evacuation shelter.	
<b>Exterior-Mounted Mechanical Equipment</b>		
<b>Section 6.3.4.1</b>		
Is there mechanical equipment mounted outside at grade or on the roof?	Anchor the equipment to resist wind loads. If there is existing equipment, evaluate the adequacy of the attachment, including attachment of cowlings, access panels, ducts, and gas lines.	
Are there penetrations through the roof?	Design intakes and exhausts to avoid water leakage.	
Is the site in a hurricane-prone region?	If yes, place the equipment in a penthouse, rather than exposed on the roof.	

Table 6-2: Checklist for building vulnerability of schools exposed to high winds

Vulnerability Sections	Guidance	Observations
<b>Exterior-Mounted Electrical and Communications Equipment</b>		
<b>Section 6.3.4.3</b>		
<b>Are there antennae (communication masts) or satellite dishes?</b>	If there are existing antennae or satellite dishes and the building is located in a hurricane-prone region, evaluate wind resistance. For antennae evaluation, see Chapter 15 of ANSI/TIA-222-G.	
<b>Does the building have an LPS?</b>	See Sections 6.3.4.3 and 6.3.4.4 for LPS attachment. For existing LPSs, evaluate wind resistance (Section 6.4.3.3)	
<b>Municipal Utilities</b>		
<b>Will the facility be used as a hurricane evacuation shelter?</b>	See Section 6.3.5 for emergency power, water, and sewer recommendations.	
<b>Is the emergency generator housed in a wind- and debris-resistant enclosure?</b>	If not, build an enclosure to provide debris protection.	
<b>Is the emergency generator’s wall louver protected from wind-borne debris?</b>	If not, install a louver or screen wall to provide debris impact protection.	

## 6.7 References and Sources of Additional Information

Note: FEMA publications may be obtained at no cost by calling (800) 480-2520, or by downloading from the library/publications section online at <http://www.fema.gov>.

American Association of State Highway and Transportation Officials (AASHTO), 2009. *Standard Specifications for Structural Supports for Highway Signs, Luminaires and Traffic Signals*, LTS-4-5.

American Institute of Architects (AIA), 1997. *Buildings at Risk: Wind Design Basics for Practicing Architects*.

American National Standards Institute (ANSI), 2003. *Wind Design Standard for Edge Systems Used in Low Slope Roofing Systems*, ANSI/SPRI ES-1.

ANSI, 2008. *Wind Design Standard for Ballasted Single-Ply Roofing Systems*, ANSI/SPRI RP-4.

ANSI/Telecommunications Industry Association (TIA), 2009. *Structural Standard for Antenna Supporting Structures and Antennas*, ANSI/TIA-222-G, Addendum 2, December 2009.

American Red Cross (ARC), 2002. *Standards for Hurricane Evacuation Shelter Selection*, Publication 4496, July 1992, rev. January 2002.

American Society of Civil Engineers (ASCE), 2005. *Minimum Design Loads for Buildings and Other Structures*, ASCE 7-05, Structural Engineering Institute, Reston, VA.

ASCE, 2010. *Minimum Design Loads for Buildings and Other Structures*, 2010 Edition, ASCE 7-10, Structural Engineering Institute, Reston, VA.

American Society for Testing and Materials (ASTM), 2004. *Standard Test Method for Field Testing Uplift Resistance of Adhered Membrane Roofing Systems*, ASTM E 907-96.

ASTM, 2005a. *Standard Test Method for Performance of Exterior Windows, Curtain Walls, Doors, and Impact Protective Systems Impacted by Missile(s) and Exposed to Cyclic Pressure Differentials*, ASTM E 1886.

ASTM, 2005b. *Standard Test Method for Structural Performance of Sheet Metal Roof and Siding Systems by Uniform Static Air Pressure Difference*, ASTM E 1592.

ASTM, 2006a. *Standard Test Method for Structural Performance of Exterior Windows, Curtain Walls, and Doors by Cyclic Static Air Pressure Differential*, ASTM E 1233.

ASTM, 2006b. *Test Method for Field Pull Testing of an In-Place Exterior Insulation and Finish System Clad Wall Assembly*, ASTM E 2359.

ASTM, 2007. *Standard Practice for Installation of Exterior Windows, Doors and Skylights*, ASTM E 2112.

ASTM, 2008. *Standard Test Method for Field Determination of Water Penetration of Installed Exterior Windows, Skylights, Doors, and Curtain Walls by Uniform or Cyclic Static Air Pressure Difference*, ASTM E 1105-00.

ASTM, 2009a. *Standard Specification for Performance of Exterior Windows, Curtain Walls, Doors and Impact Protective Systems Impacted by Windborne Debris in Hurricanes*, ASTM E 1996.

American Society of Heating, Refrigerating and Air Conditioning Engineers (ASHRAE), 2006. *Calculating Wind Loads and Anchorage Requirements for Rooftop Equipment*.

ASHRAE, 2007a. *Standard 62.1 User's Manual*.

ASHRAE, 2007b. *Ventilation for Acceptable Indoor Air Quality, Standard 62.1*.

Baskaran, B, and T.L. Smith, 2005. *A Guide for the Wind Design of Mechanically Attached Flexible Membrane Roofs*, Institute for Research in Construction, National Research Council of Canada.

Door and Access Systems Manufacturers Association, 2008. *Connecting Garage Door Jambs to Building Framing*, Technical Data Sheet #161, December 2003, revised May 2008.

Edwards, Roger, 2009. The Online Tornado FAQ, Storm Prediction Center, NOAA. [www.spc.noaa.gov/faq/tornado/#History](http://www.spc.noaa.gov/faq/tornado/#History), last modified December 31, 2009.

Factory Mutual Research, *Approval Guide*, Norwood, MA, updated quarterly.

Federal Emergency Management Agency (FEMA), 1992. *Building Performance: Hurricane Andrew in Florida*, FEMA FIA-22, Washington, DC, December 1992.

FEMA, 1993. *Building Performance: Hurricane Iniki in Hawaii*, FEMA FIA-23, Washington, DC, January 1993.

FEMA, 1996. *Corrosion Protection for Metal Connectors in Coastal Areas*, FEMA Technical Bulletin 8-96, Washington, DC, August 1996.

FEMA, 1998. *Typhoon Paka: Observations and Recommendations on Building Performance and Electrical Power Distribution System*, FEMA-1193-DR-GU, Washington, DC, March 1998.

FEMA, 1999a. *Hurricane Georges in Puerto Rico*, FEMA 339, Washington, DC, March 1999.

FEMA, 1999b. *Oklahoma and Kansas Midwest Tornadoes of May 3, 1999*, FEMA 342, Washington, DC, October 1999.

FEMA, 2000. *Coastal Construction Manual*, FEMA 55, CD (3rd Edition).

FEMA, 2002. *Installing Seismic Restraints for Mechanical Equipment*, FEMA 412, Washington, DC, December 2002.

FEMA, 2003a. *Primer to Design Safe School Projects in Case of Terrorist Attacks*, FEMA 428, December 2003.

FEMA, 2003b. *Tornado Protection, Selecting Safe Areas in Buildings*, FEMA 431, Washington, DC, October 2003.



FEMA, 2004a. *Installing Seismic Restraints for Duct and Pipe*, FEMA 414, Washington, DC, January 2004.

FEMA, 2004b. *Installing Seismic Restraints for Electrical Equipment*, FEMA 413, Washington, DC, January 2004.

FEMA, 2005a. *MAT Report: Hurricane Charley in Florida*, FEMA 488, Washington, DC, April 2005.

FEMA, 2005b. *MAT Report: Hurricane Ivan in Alabama and Florida*, FEMA 489, Washington, DC, August 2005.

FEMA, 2006a. *Design Guidance for Shelters and Safe Rooms*, FEMA 453, Washington, DC.

FEMA, 2006b. *MAT Report: Hurricane Katrina in the Gulf Coast*, FEMA 549, Washington, DC, July 2006.

FEMA, 2007. *Design Guide for Improving Critical Facility Safety from Flooding and High Winds*, FEMA 543, Washington, DC, January 2007.

FEMA, 2008a. *Design and Construction Guidance for Community Safe Rooms*, FEMA 361, Washington, DC, November 2008.

FEMA, 2008b. *Taking Shelter From the Storm: Building a Safe Room Inside Your House*, FEMA 320, Washington, DC, August 2008.

FEMA, 2009. *MAT Report: Hurricane Ike in Texas and Louisiana*, FEMA P-757, Washington, DC, April 2009.

FEMA, 2010. *Home Builder's Guide to Coastal Construction Technical Fact Sheet Series*, FEMA P-499, December 2010.

FM Global, dates vary. *Loss Prevention Data for Roofing Contractors*, Norwood, MA.

Institute of Electrical and Electronics Engineers, Inc. (IEEE), 2008. *National Electrical Code*, NFPA 70.

International Code Council (ICC), 2008. *ICC/NSSA Standard on the Design and Construction of Storm Shelters*, ICC 500-2008, Country Club Hills, IL.

ICC, 2009. 2006 *International Building Code*, ICC IBC-2009, February 2009.

National Research Council of Canada, 2005. *Wind Design Guide for Mechanically Attached Flexible Membrane Roofs*, B1049.

## 6.8 Glossary of High Wind Protection Terms

**Astragal.** The center member of a double door, which is attached to the fixed or inactive door panel.

**Basic wind speed.** A 3-second gust speed at 33 feet above the ground in Exposure C. (Exposure C is flat open terrain with scattered obstructions having heights generally less than 30 feet.) Note: Since 1995, ASCE 7 has used a 3-second peak gust measuring time. A 3-second peak gust is the maximum instantaneous speed with a duration of approximately 3 seconds. A 3-second peak gust speed could be associated with a given windstorm (e.g., a particular storm could have a 40-mph peak gust speed), or a 3-second peak gust speed could be associated with a design level event (e.g., the basic wind speed prescribed in ASCE 7).

**Building, enclosed.** A building that does not comply with the requirements for open or partially enclosed buildings.

**Building, open.** A building having each wall at least 80 percent open. This condition is expressed by an equation in ASCE 7.

**Building, partially enclosed.** A building that complies with both of the following conditions:

1. The total area of openings in a wall that receives positive external pressure exceeds the sum of the areas of openings in the balance of the building envelope (walls and roof) by more than 10 percent.
2. The total area of openings in a wall that receives positive external pressure exceeds 4 square feet, or 1 percent of the area of that wall, whichever is smaller, and the percentage of openings in the balance of the building envelope does not exceed 20 percent.

These conditions are expressed by equations in ASCE 7.

**Building, simple diaphragm.** An enclosed or partially enclosed building in which wind loads are transmitted through floor and roof diaphragms to the vertical main wind-force resisting system.

**Components and cladding (C&C).** Elements of the building envelope that do not qualify as part of the main wind-force resisting system.

**Coping.** The cover piece on top of a wall exposed to the weather, usually made of metal, masonry, or stone, and sloped to carry off water.

**Downburst.** Also known as a microburst. A powerful downdraft associated with a thunderstorm.

**Down-slope wind.** A wind blowing down the slope of mountains (frequently occurs in Alaska and Colorado).

**Escarpment.** Also known as a scarp. With respect to topographic effects, a cliff or steep slope generally separating two levels or gently sloping areas.

**Exposure.** The characteristics of the ground roughness and surface irregularities in the vicinity of a building. ASCE 7 defines three exposure categories—Exposures B, C, and D.

**Extratropical storm.** A cyclonic storm that forms outside of the tropical zone. Extratropical storms may be large, often 1,500 miles (2,400 kilometers) in diameter, and usually contain a cold front that extends toward the equator for hundreds of miles.

**Flashing.** Any piece of material, usually metal or plastic, installed to prevent water from penetrating a structure.

**Glazing.** Glass or a transparent or translucent plastic sheet used in windows, doors, and skylights.

**Glazing, impact-resistant.** Glazing that has been shown, by an approved test method, to withstand the impact of wind-borne missiles likely to be generated in wind-borne debris regions during design winds.

**Hurricane-prone regions.** Areas vulnerable to hurricanes; in the United States and its territories defined as:

1. The U.S. Atlantic Ocean and Gulf of Mexico coasts, where the basic wind speed is greater than 120 miles per hour.<sup>41</sup>
2. Hawaii, Puerto Rico, Guam, U.S. Virgin Islands, and American Samoa.

**Impact-resistant covering.** A covering designed to protect glazing, which has been shown by an approved test method to withstand the impact of wind-borne missiles likely to be generated in wind-borne debris regions during design winds.

**Importance factor, I.** A factor that accounts for the degree of hazard to human life and damage to property. Importance factors are given in

---

<sup>41</sup> The 120-mph basic wind speed is based on ASCE 7-10, Risk Category III and IV buildings. If ASCE 7-05 or an earlier version is used, the equivalent wind speed trigger is 90 mph.

ASCE 7. Note: In ASCE 7-10, the importance factor was eliminated for wind loads because the degree of hazard to human life and property damage is accounted for by the proper map selection.

**Main wind-force resisting system.** An assemblage of structural elements assigned to provide support and stability for the overall structure. The system generally receives wind loading from more than one surface.

**Mean roof height,  $h$ .** The average of the roof eave height and the height to the highest point on the roof surface, except that, for roof angles of less than or equal to 10 degrees, the mean roof height shall be the roof eave height.

**Missiles.** Debris that could become propelled into the wind stream.

**Nor'easter.** Nor'easters are non-tropical storms that typically occur in the eastern United States, any time between October and April, when moisture and cold air are plentiful. They are known for dumping heavy amounts of rain and snow, producing hurricane-force winds, and creating high surfs that cause severe beach erosion and coastal flooding. A nor'easter is named for the winds that blow in from the northeast and drive the storm along the east coast and the Gulf Stream, a band of warm water that lies off the Atlantic Coast.

**Openings.** Apertures or holes in the building envelope that allow air to flow through the building envelope. A door that is intended to be in the closed position during a windstorm would not be considered an opening. Glazed openings are also not typically considered openings. However, if the building is located in a wind-borne debris region and the glazing is not impact-resistant or protected with an impact-resistant covering, the glazing is considered an opening.

**Racking.** Lateral deflection of a structure resulting from external forces, such as wind or lateral ground movement in an earthquake.

**Ridge.** With respect to topographic effects, an elongated crest of a hill characterized by strong relief in two directions.

**Straight-line wind.** A wind blowing in a straight line with wind speeds ranging from very low to very high (the most common wind occurring throughout United States and its territories).

**Wind-borne debris regions.** Areas within hurricane-prone regions, as defined in ASCE 7.





# Design Guide

for Improving School Safety  
in Earthquakes, Floods, and High Winds

## A Acronyms

<b>AASHTO</b>	American Association of State Highway and Transportation Officials
<b>ADA</b>	Americans with Disabilities Act
<b>ARC</b>	American Red Cross
<b>ASCE</b>	American Society of Civil Engineers
<b>ASFPM</b>	Association of State Floodplain Managers
<b>ASHRAE</b>	American Society of Heating, Refrigerating and Air Conditioning Engineers
<b>ASTM</b>	American Society for Testing and Materials
<b>ATC</b>	Applied Technology Council
<b>BFE</b>	Base flood elevation
<b>BOCA</b>	Building Officials and Code Administrators International, Inc.
<b>BSSC</b>	Building Seismic Safety Council
<b>BUR</b>	Built-up roof
<b>CBR</b>	Chemical, biological, or radiological
<b>C&amp;C</b>	Components and cladding
<b>CFR</b>	Code of Federal Regulations
<b>CMU</b>	Concrete Masonry Unit

<b>CSSC</b>	California Seismic Safety Commission
<b>DFE</b>	Design flood elevation
<b>EIFS</b>	Exterior insulation finish system
<b>ELF</b>	Equivalent Lateral Force
<b>EPDM</b>	Ethylene propylene diene monomer
<b>FEMA</b>	Federal Emergency Management Agency
<b>FIRM</b>	Flood Insurance Rate Map
<b>FIS</b>	Flood Insurance Study
<b>FMG</b>	FM Global
<b>FMR</b>	Factory Mutual Research
<b>GIS</b>	Geographic Information System
<b>HazMat</b>	Hazardous Materials
<b>HAZUS-MH</b>	Hazards U.S. Multi-Hazards
<b>HVAC</b>	Heating, ventilation, and air conditioning
<b>IBC</b>	International Building Code
<b>ICBO</b>	International Conference of Building Officials
<b>ICC</b>	International Code Council
<b>ICC PC</b>	International Code Council Performance Code
<b>IT</b>	Information Technology
<b>LCD</b>	Liquid crystal display
<b>LiMWA</b>	Limit of Moderate Wave Action
<b>LPS</b>	Lightning protection system
<b>M/E/P</b>	Mechanical/Electrical/Plumbing
<b>MEPS</b>	Molded expanded polystyrene
<b>MMI</b>	Modified Mercalli Intensity
<b>MWFRS</b>	Main wind-force resisting system
<b>NBC</b>	National Building Code
<b>NEHRP</b>	National Earthquake Hazards Reduction Program
<b>NFPA</b>	National Fire Protection Association
<b>NFIP</b>	National Flood Insurance Program

---

<b>NIBS</b>	National Institute of Building Sciences
<b>O&amp;M</b>	Operations and Maintenance
<b>OSB</b>	Oriented strand board
<b>PMR</b>	Protected membrane roof
<b>RC</b>	Reinforced concrete
<b>RSP</b>	Rapid Screening Procedure
<b>SBC</b>	Standard Building Code
<b>SBCCI</b>	Southern Building Code Congress International, Inc.
<b>SDC</b>	Seismic Design Category
<b>SEI</b>	Structural Engineering Institute
<b>SFHA</b>	Special flood hazard area
<b>SPF</b>	Sprayed polyurethane foam
<b>SPRI</b>	Single Ply Roofing Industry
<b>TAS</b>	Testing Application Standard
<b>TIA</b>	Telecommunications Industry Association
<b>UBC</b>	Uniform Building Code
<b>UL</b>	Underwriters Laboratories
<b>URM</b>	Unreinforced masonry
<b>USACE</b>	U.S. Army Corps of Engineers
<b>U.S.C.</b>	U.S. Code
<b>USGS</b>	U.S. Geological Survey









**FEMA**

**FEMA P-424**  
Catalog No: