

ارائه به روزترین منابع، کتابها و جزوات مهندسی عمران
به زبان فارسی و انگلیسی به صورت کاملاً رایگان

www.TheSetosa.com



Guidelines for Design of Structures for Vertical Evacuation from Tsunamis

Third Edition

FEMA P-646 / August 2019



FEMA



Guidelines for Design of Structures for Vertical Evacuation from Tsunamis

Third Edition

Prepared by
APPLIED TECHNOLOGY COUNCIL
201 Redwood Shores Parkway, Suite 240
Redwood City, California 94065
www.ATCouncil.org

Prepared for
FEDERAL EMERGENCY MANAGEMENT AGENCY
National Earthquake Hazard Reduction Program
Michael Mahoney, FEMA Project Officer
Robert D. Hanson, FEMA Technical Monitor

NATIONAL OCEANIC AND ATMOSPHERIC ADMINISTRATION
National Tsunami Hazard Mitigation Program

APPLIED TECHNOLOGY COUNCIL

Jon A. Heintz (Project Executive/Project Manager)
Christopher Rojahn (Project Executive)
William L. Coulbourne (Project Manager)
Ayse Hortacsu (Project Manager)
William T. Holmes (ATC Technical Monitor)

SUBJECT MATTER EXPERT/ LEAD AUTHOR (THIRD EDITION)

Ian N. Robertson

PROJECT MANAGEMENT COMMITTEE (SECOND EDITION)

Ian N. Robertson (Project Technical Director)
Gary Chock
John Hooper
Timothy J. Walsh
Harry Yeh

PROJECT REVIEW PANEL (THIRD EDITION)

Tamra Biasco
Gary Chock
Maximillian Dixon
John Hooper
Michael Hornick
Laura Kong
Kevin Miller
Amanda Siok

PROJECT MANAGEMENT COMMITTEE (FIRST EDITION)

Steven Baldrige (Project Technical Director)
Frank Gonzalez
John Hooper
Ian N. Robertson
Timothy J. Walsh
Harry Yeh



PROJECT REVIEW PANEL
(FIRST EDITION)

Christopher P. Jones (Chair)
John Aho
George Crawford
Richard Eisner
Lesley Ewing
Michael Hornick
Chris Jonientz-Trisler
Marc L. Levitan
George Priest
Charles W. Roeder
Jay Wilson

REPORT PREPARATION CONSULTANTS
(FEMA P-646A)

J.L. Clark
George Crawford

PROJECT REVIEW PANEL
(FEMA P-646A)

Lesley Ewing
James D. Goltz
William T. Holmes
Ervin Petty
George Priest
Althea Turner
Timothy J. Walsh

Notice

Any opinions, findings, conclusions, or recommendations expressed in this publication do not necessarily reflect the views of the Federal Emergency Management Agency (FEMA), the National Oceanic & Atmospheric Administration (NOAA), or the Applied Technology Council (ATC). Additionally, neither ATC, FEMA, NOAA, nor any of their employees, make any warranty, expressed or implied, or assumes any legal liability or responsibility for the accuracy, completeness, or usefulness of any information, product, or process included in this publication. Users of information in this publication assume all liability arising from such use.

Cover Images: Photographs showing examples of actual or potential vertical evacuation structures. Clockwise from top left: (1) designated vertical evacuation building in Kesennuma Port, Japan, where numerous residents found safe refuge at the roof level during the 2011 Tohoku tsunami; (2) rooftop vertical evacuation refuge over a gymnasium at Ocosta Elementary School, Westport, Washington; (3) multi-level cast-in-place reinforced concrete parking garage in Biloxi, Mississippi, which survived storm surge inundation during Hurricane Katrina in 2005; and (4) earthen mound with ramp access to a safe elevation. Photographs provided courtesy of P. Akerlund, Ocosta School District, Westport, Washington; J. Hooper, Magnusson Klemencic Associates, Seattle, Washington; and I. Robertson, University of Hawaii at Manoa.

Foreword

This publication was funded equally by the National Oceanic and Atmospheric Administration (NOAA), which leads the National Tsunami Hazard Mitigation Program (NTHMP) and by the Federal Emergency Management Agency (FEMA), which is responsible for the implementation portion of the National Earthquake Hazard Reduction Program (NEHRP).

FEMA initiated this project in September 2004 with a contract to the Applied Technology Council. The project was undertaken to address the need for guidance on how to build a structure that would be capable of resisting the extreme forces of both a tsunami and an earthquake. This question was driven by the fact that there are many communities along our nation's west coast that are located on narrow spits of land and are vulnerable to a tsunami triggered by an earthquake on the Cascadia subduction zone, which could potentially generate a tsunami of 20 feet in elevation, or more, within 20 minutes. Given their location, it would be impossible to evacuate these communities in time, which could result in a significant loss of life. Many coastal communities located in other parts of the country are subject to tsunami risk and have the same potential problem. In these cases, the only feasible alternative is vertical evacuation, using specially designed, constructed and designated structures built to resist both tsunami and earthquake loads.

The significance of this issue came into sharp relief with the December 26, 2004 Sumatra earthquake and Indian Ocean tsunami, and the March 11, 2011 Tohoku, Japan tsunami. While these events resulted in a tremendous loss of life, it would have been even worse had not many people been able to take refuge in multi-story reinforced concrete or structural steel buildings, or been able to get to locations of high ground after a tsunami warning was delivered. Without realizing it, these survivors were demonstrating the concept of vertical evacuation from tsunamis.

This publication presents the following information:

- General information on the tsunami hazard and its history;
- Guidance on determining the tsunami hazard, including the need for tsunami depth and velocity on a site-specific basis;

- Different options for vertical evacuation from tsunamis;
- Determination of tsunami and earthquake loads and structural design criteria necessary to address them; and
- Structural design concepts and other considerations.

This is the third edition of FEMA P-646, originally published in June 2008. In this third edition, revisions were made throughout the document, but particularly in the following areas:

- Expanded guidance on planning for vertical evacuation
- Additional guidance and commentary on structural design criteria contained in the new Chapter 6, “Tsunami Loads and Effects” of ASCE/SEI 7-16, *Minimum Design Loads and Associated Criteria for Buildings and Other Structures* (ASCE, 2016);
- Inclusion of guidance on using existing structures for vertical evacuation; and
- Operational guidance for tsunami vertical evacuation structures.

This third edition builds on the second edition, which included observations and lessons learned from the March 11, 2011 Tohoku tsunami; revised and enhanced the debris impact expression to remove over-conservatism in the prior edition; and updated reference documents to the most current versions.

FEMA had also originally issued a companion document in 2009, FEMA P-646A, *Vertical Evacuation from Tsunamis: A Guide for Community Officials*, which presented information on the use of this design guidance at the State and local levels. Material from that companion guide has been incorporated into this third edition to make it a single resource, and the companion guide has been removed from circulation.

FEMA is grateful to the original Project Management Committee of Steve Baldrige, John Hooper, Ian Robertson, Tim Walsh, and Harry Yeh, the original Project Review Panel, the staff of the Applied Technology Council, and all of the participants listed at the end of this document. Updates included in the second edition were made thanks to Ian Robertson, Gary Chock, John Hooper, Tim Walsh, and Harry Yeh. Updates included in this third edition were made thanks to Ian Robertson. The hard work of all these individuals has provided the nation with the first document of its kind, a manual on how citizens can, for the first time, be able to survive a tsunami, one of the most terrifying natural hazards known.

Federal Emergency Management Agency

Preface

In September 2004, the Applied Technology Council (ATC) was awarded a “Seismic and Multi-Hazard Technical Guidance Development and Support” contract (HSFEHQ-04-D-0641) by the Federal Emergency Management Agency (FEMA) to conduct a variety of tasks, including one entitled “Development of Design and Construction Guidance for Special Facilities for Vertical Evacuation from Tsunamis,” designated the ATC-64 Project. This project included a review of available international research and state-of-the-practice techniques regarding quantification of tsunami hazard and tsunami force effects.

This work resulted in the publication of the first edition of the FEMA P-646 report, *Guidelines for Design of Structures for Vertical Evacuation from Tsunamis* (FEMA, 2008), providing technical guidance and approaches for tsunami-resistant design, identification of relevant tsunami loads and applicable design criteria, development of methods to calculate tsunami loading, and identification of architectural and structural system attributes suitable for use in vertical evacuation facilities. A year later, a companion report, FEMA P-646A, *Vertical Evacuation from Tsunamis: A Guide for Community Officials* (FEMA, 2009) was released providing information on vertical evacuation strategies, and how to plan, design, and construct vertical evacuation refuges at the state and local government levels.

Following its initial publication, FEMA P-646 was used in conceptual design studies as part of tsunami evacuation planning in Cannon Beach, Oregon. It was also used in ongoing research related to the development of Performance-Based Tsunami Engineering conducted at the University of Hawaii at Manoa, under the George E. Brown, Jr. Network for Earthquake Engineering Simulation (NEES). Based on findings from these activities, FEMA initiated a follow-up contract, designated the ATC-79 Project, to review the design guidance contained in FEMA P-646, and to consider updates, if needed, based on this new information.

As a result of this review, selected revisions were deemed necessary, leading to the publication of the second edition of FEMA P-646 in 2012. Changes in the second edition related to: (1) inclusion of observations and lessons learned from the March 11, 2011 Tohoku tsunami; (2) revision of the debris

impact expression to remove over-conservatism deemed to be present in the prior edition; (3) refinement of the definition of tsunami elevation as it relates to runup elevation used in tsunami force equations; and (4) update of reference documents to the most current versions of each.

In 2011, the American Society of Civil Engineers (ASCE) created a new Tsunami Loads and Effects Sub-Committee (TLESC) charged with development of code provisions for tsunami design of coastal buildings and other structures. A new Chapter 6, “Tsunami Loads and Effects,” was added in the 2016 version of the ASCE/SEI 7 standard, *Minimum Design Loads and Associated Criteria for Buildings and Other Structures* (ASCE, 2016). Tsunami design provisions have now been adopted by reference in the 2018 edition of the International Building Code (ICC, 2018).

Many of the design provisions contained in prior editions of FEMA P-646 have been augmented or replaced by provisions in ASCE/SEI 7-16. To avoid conflicts with ASCE/SEI 7-16, FEMA commissioned ATC to develop this third edition of FEMA P-646, which has been revised to serve as a guide for community resource planning related to vertical evacuation, and to provide additional background, guidance, and commentary on the technical design provisions now contained in ASCE/SEI 7-16. As a result, portions of the FEMA P-646A report providing guidance to community officials on vertical evacuation planning have now been incorporated into this report.

ATC is indebted to Ian Robertson who led the third edition update, and to the following reviewers who provided input and guidance on the development of this report, including Tamra Biasco, Gary Chock, Maximilian Dixon, John Hooper, Michael Hornick, Laura Kong, Kevin Miller, and Amanda Siok.

ATC remains indebted to the members of the original ATC-64 and second edition ATC-79 Project Teams for the development of the original source materials for this report. Members of the original ATC-64 Project Team included a Project Management Committee consisting of Steven Baldrige (Project Technical Director), Frank Gonzalez, John Hooper, Ian Robertson, Tim Walsh, and Harry Yeh, and a Project Review Panel consisting of Christopher Jones (Chair), John Aho, George Crawford, Richard Eisner, Lesley Ewing, Michael Hornick, Chris Jonientz-Trisler, Mark Levitan, George Priest, Charles Roeder, and Jay Wilson.

Members of the second edition ATC-79 Project Team included a Project Management Committee consisting of Ian Robertson (Project Technical Director), Gary Chock, John Hooper, Tim Walsh, and Harry Yeh.

Members of the FEMA P-646A report development team included Report Preparation Consultants J.L. Clark and George Crawford, and a Project Review Panel consisting of Lesley Ewing, James Goltz, William Holmes, Ervin Petty, George Priest, Althea Turner, and Tim Walsh.

In addition, ATC gratefully acknowledges the contributions of the following individuals who assisted in the development of one or more editions of the FEMA P-646 and FEMA P-646A reports: Michael Mahoney (FEMA Project Officer), Robert Hanson (FEMA Technical Monitor), William Holmes (ATC Technical Monitor), and Peter N. Mork, Bernadette Hadnagy, and Carrie J. Perna (ATC report production services).

The names and affiliations of those who participated in the development of each edition of the FEMA P-646 and FEMA P-646A reports are provided in the list of Project Participants at the end of this report.

Jon A. Heintz
ATC Executive Director

Table of Contents

Foreword.....	iii
Preface.....	v
List of Figures.....	xiii
List of Tables	xix
1. Introduction.....	1-1
1.1 Objectives and Scope	1-1
1.2 Tsunami Refuge Versus Shelter	1-3
1.3 Tsunami Hazard Versus Risk	1-3
1.4 Reasons to Construct a Vertical Evacuation Refuge Structure	1-4
1.5 Limitations	1-4
1.6 Organization and Content.....	1-5
2. Background on Historic Tsunami Effects.....	2-1
2.1 Categorization, Behavior, and Characteristics of Tsunamis.....	2-1
2.1.1 Historic Tsunami Activity	2-3
2.1.2 Behaviors and Characteristics of Tsunamis.....	2-6
2.2 Tsunami Effects on Buildings	2-11
2.2.1 Historic Data on Tsunami Effects	2-12
2.2.2 Observations from the 2004 Indian Ocean Tsunami	2-15
2.2.3 Observations from the 2011 Tohoku Tsunami	2-19
2.2.4 Observations from 2005 Hurricane Katrina	2-27
2.2.5 Observations from 2012 Hurricane Sandy	2-30
2.3 Implications for Tsunami-Resistant Design	2-31
3. Planning and Funding.....	3-1
3.1 Tsunami Awareness and Preparation	3-1
3.1.1 TsunamiReady Program	3-1
3.2 Decision-Making Process.....	3-3
3.3 Making Tough Choices	3-6
3.3.1 Long-Term View	3-7
3.3.2 Potential Liability	3-7
3.4 Quantifying Tsunami Hazard	3-7
3.4.1 Considering Concurrent Hazards.....	3-8
3.5 Vulnerability and Risk Assessment.....	3-9
3.6 Use of Evacuation Modeling	3-10
3.7 Considering the Need for Vertical Evacuation.....	3-11
3.8 Cost Considerations for Vertical Evacuation Structures	3-13
3.9 Potential Sources of Funding	3-14
3.9.1 Federal Funds	3-15

3.9.2	Public-Private Partnership	3-16
3.9.3	Self-Funding	3-16
3.9.4	State and Local Revenue.....	3-17
3.10	Planning for Vertical Evacuation Structures	3-17
3.10.1	Land Use Planning	3-18
3.11	Permitting and Quality Assurance for Vertical Evacuation Structures	3-19
3.11.1	Permitting and Code Compliance.....	3-19
3.11.2	Peer Review.....	3-19
3.11.3	Quality Assurance / Quality Control.....	3-19
4.	Options for Vertical Evacuation	4-1
4.1	Vertical Evacuation Considerations.....	4-1
4.1.1	Single-Purpose Facilities	4-1
4.1.2	Multi-Purpose Facilities.....	4-2
4.1.3	Multi-Hazard Considerations.....	4-3
4.2	Vertical Evacuation Concepts.....	4-3
4.2.1	Existing High Ground.....	4-3
4.2.2	Soil Berms.....	4-4
4.2.3	Multi-Story Parking Garages	4-5
4.2.4	Community Facilities.....	4-6
4.2.5	Commercial and Residential Facilities	4-6
4.2.6	School Facilities.....	4-7
4.2.7	Existing Buildings.....	4-8
5.	Siting, Spacing, Sizing, and Elevation Considerations.....	5-1
5.1	Siting Considerations.....	5-1
5.1.1	Warning, Travel Time, and Spacing	5-1
5.1.2	Ingress and Vertical Circulation	5-3
5.1.3	Consideration of Site Hazards	5-4
5.2	Sizing Considerations	5-7
5.2.1	Services and Occupancy Duration.....	5-7
5.2.2	Square Footage Recommendations from Available Sheltering Guidelines.....	5-8
5.2.3	Recommended Minimum Square Footage for Short- Term Vertical Evacuation Refuge Structures	5-9
5.3	Elevation Considerations	5-10
5.4	Size of Vertical Evacuation Structures	5-11
6.	Operation and Maintenance	6-1
6.1	Facility Operations Plan	6-1
6.2	Pre-Tsunami Public Education	6-2
6.3	Tsunami Warnings.....	6-3
6.4	Opening the Vertical Evacuation Structure	6-4
6.5	Operating the Vertical Evacuation Structure	6-6
6.6	Leaving the Vertical Evacuation Structure.....	6-8
6.7	Maintenance.....	6-9
6.8	Long-Term Issues	6-9
7.	Tsunami Hazard Assessment.....	7-1
7.1	Tsunami Modeling and Inundation Mapping	7-1

7.2	The NOAA Tsunami Program: Forecast Modeling and Mapping	7-2
7.3	Hazard Quantification for Design of Tsunami Vertical Evacuation Structures.....	7-4
7.4	ASCE Tsunami Design Geodatabase	7-6
	7.4.1 Development of Maximum Considered Tsunami Design Parameters	7-7
	7.4.2 Probabilistic Tsunami Hazard Analysis.....	7-8
7.5	Recommendations for Improving Tsunami Hazard Assessment	7-9
8.	Load Determination and Structural Design Criteria.....	8-1
8.1	Previously Available Structural Design Criteria	8-1
	8.1.1 Guidelines, Codes, and Standards	8-2
	8.1.2 Limitations in Previously Available Flood Design Criteria Relative to Tsunami Loading	8-4
8.2	ASCE/SEI 7-16 Tsunami Loads and Effects.....	8-5
	8.2.1 Tsunami Risk Categories.....	8-5
	8.2.2 Determination of Design Inundation Depth and Flow Velocity	8-6
	8.2.3 Structural Design Procedures	8-6
8.3	Performance Objectives	8-7
	8.3.1 Tsunami Performance Objectives.....	8-8
8.4	Earthquake Loads	8-9
	8.4.1 Near-Source-Generated Tsunamis.....	8-10
	8.4.2 Far-Source-Generated Tsunamis	8-11
8.5	Wind Loads	8-11
8.6	Tsunami Loads	8-11
	8.6.1 Key Assumptions for Estimating Tsunami Loads and Effects.....	8-12
	8.6.2 Hydrostatic Loads.....	8-14
	8.6.3 Hydrodynamic Loads	8-16
	8.6.4 Impulsive Forces.....	8-17
	8.6.5 Debris Impact Forces.....	8-17
	8.6.6 Damming of Accumulated Waterborne Debris	8-19
	8.6.7 Uplift Forces on Elevated Floors.....	8-19
	8.6.8 Additional Retained Water Loading on Elevated Floors	8-20
8.7	Combination of Tsunami Forces	8-21
	8.7.1 Tsunami Load Cases Acting on the Overall Structure	8-21
	8.7.2 Tsunami Load Cases Acting on Individual Components	8-22
8.8	Tsunami Load Combinations	8-23
8.9	Progressive Collapse Considerations	8-23
	8.9.1 Department of Defense Methodology	8-24
	8.9.2 General Services Administration Methodology.....	8-26
8.10	Structural Countermeasures for Tsunami Load Effects	8-27
	8.10.1 Foundation Scour Design Concepts.....	8-27
	8.10.2 Breakaway Wall Design Concepts.....	8-27

9. Considerations for Existing Buildings	9-1
9.1 Attributes of Tsunami-Resistant Structures	9-1
9.2 Criteria for Evaluation of Existing Buildings	9-1
9.3 Considerations for Existing Buildings	9-2
9.3.1 Concepts for Retrofitting Existing Buildings.....	9-4
9.4 Tsunami Refuge of Last Resort	9-5
Appendix A: Vertical Evacuation Structure Examples	A-1
Appendix B: Community Design Example	B-1
B.1 Site 1 Example: Escape Berm.....	B-3
B.2 Site 2 Example: Multi-Use Structure.....	B-6
Glossary.....	C-1
References	D-1
Project Participants.....	E-1

List of Figures

Figure 2-1	Maximum computed offshore tsunami amplitudes in the Pacific Ocean for the 2004 Indian Ocean tsunami.....	2-7
Figure 2-2	Schematic diagrams of the vertical displacement resulting from subduction-type fault dislocation: (a) rupture zone located far offshore; and (b) rupture zone adjacent to coastline with coastal subsidence.....	2-8
Figure 2-3	Contrasting tide gage records for the 2004 Indian Ocean tsunami at: (a) Ta Phao Noi, Thailand, showing the leading depression wave at a near site; and (b) Tuticorin, India, showing the leading elevation wave at a distant site.....	2-9
Figure 2-4	Measured runup heights in the 1993 Okushiri tsunami along Inaho Coast, Japan, demonstrating that runup height varies significantly between neighboring areas	2-10
Figure 2-5	Sketch of a bore and photo from the 1983 Nihonkai-Chubu tsunami showing the formation of a bore offshore	2-10
Figure 2-6	Sketch of a surge and photo from the 1983 Nihonkai-Chubu tsunami showing the formation of a surge	2-11
Figure 2-7	A sequence of photos from the 1983 Nihonkai-Chubu tsunami showing surge flooding from tsunami runup	2-11
Figure 2-8	Degrees of building damage versus tsunami runup height	2-12
Figure 2-9	Scotch Cap Lighthouse destroyed by the 1946 Aleutian tsunami.....	2-13
Figure 2-10	Total destruction of a group of wood-frame houses in Aonae Village, Okushiri Island, Japan, 1993 Okushiri tsunami.....	2-14
Figure 2-11	Beach houses with varying levels of damage in El Popoyo, Nicaragua, 1992 Nicaragua tsunami.....	2-14
Figure 2-12	Damage caused by impact from water-borne debris (fishing boat) in Aonae, Japan, 1993 Okushiri tsunami... ..	2-15
Figure 2-13	Examples of reinforced concrete structures that survived the 1993 Okushiri tsunami: vista house at Cape Inaho and fish market in Aonae.....	2-15
Figure 2-14	Damaged masonry beach house in Devanaanpattinam, India, 2004 Indian Ocean tsunami	2-16

Figure 2-15	Example of surviving reinforced concrete mosque in Uleele, Banda Aceh, Indonesia, 2004 Indian Ocean tsunami.....	2-16
Figure 2-16	Examples of waterborne debris from the 2004 Indian Ocean tsunami.....	2-17
Figure 2-17	Damage to non-engineered concrete columns due to debris impact, 2004 Indian Ocean tsunami.....	2-17
Figure 2-18	Damage to corner column due to debris damming, 2004 Indian Ocean tsunami.....	2-18
Figure 2-19	Scour around shallow spread footing in Khao Lak area, Thailand, 2004 Indian Ocean tsunami.....	2-18
Figure 2-20	Uplift damage to precast concrete floor panels and harbor piers, 2004 Indian Ocean tsunami.....	2-19
Figure 2-21	Examples of structural collapse due to strong ground shaking in Banda Aceh, Indonesia prior to inundation from the 2004 Indian Ocean tsunami.....	2-20
Figure 2-22	Scene of near-total devastation in Minamisanriku, Japan, 2011 Tohoku tsunami.....	2-21
Figure 2-23	Designated tsunami evacuation building in Minamisanriku, Japan, and trace of tsunami inundation level on evacuation signage, 2011 Tohoku tsunami.....	2-22
Figure 2-24	Exterior elevator and stairway access to large roof evacuation area protected by 2-meter high braced guard fence on tsunami evacuation building in Minamisanriku, Japan.....	2-22
Figure 2-25	Earthen mound at the west end of the Port of Sendai, Japan, 2011 Tohoku tsunami.....	2-23
Figure 2-26	Surviving and damaged reinforced concrete buildings in Minamisanriku, Japan, 2011 Tohoku tsunami.....	2-24
Figure 2-27	Collapsed upper story of reinforced concrete building with steel truss roof, 2011 Tohoku tsunami.....	2-24
Figure 2-28	Overturned cold storage building in Onagawa, Japan, 2011 Tohoku tsunami.....	2-25
Figure 2-29	Overturned steel-frame office building in Onagawa, Japan, 2011 Tohoku tsunami.....	2-26
Figure 2-30	Overturned three-story commercial building on a mat foundation in Onagawa, Japan, 2011 Tohoku tsunami....	2-26
Figure 2-31	Office building in Pass Christian, Mississippi, with a cast-in-place concrete pan joist floor system that suffered nonstructural damage in the first two stories, but no structural damage, 2005 Hurricane Katrina.....	2-28

Figure 2-32	Progressive collapse of upper floors of a parking garage due to damage in lower level columns from impact of an adjacent barge-mounted casino, 2005 Hurricane Katrina	2-28
Figure 2-33	Failure of prestressed piles due to damming effect of shipping container, 2005 Hurricane Katrina.....	2-29
Figure 2-34	Negative bending failure of a prestressed double-tee floor system due to uplift forces, 2005 Hurricane Katrina	2-29
Figure 3-1	Examples of tsunami evacuation signage used to identify evacuation routes in Alaska, California, Hawaii, Oregon, and Washington, and used to identify a designated assembly area in Puerto Rico	3-2
Figure 3-2	Signage indicating that Rockaway Beach, Oregon is designated as TsunamiReady following the completion of steps to reduce tsunami risk.....	3-2
Figure 3-3	Flowchart of decision-making process for vertical evacuation refuge planning.....	3-4
Figure 3-4	Tsunami evacuation map for Bandon, Oregon	3-12
Figure 3-5	Tsunami evacuation refuge over a cafeteria and gymnasium at Ocosta Elementary School, Westport, Washington	3-15
Figure 4-1	Soil berm in a community park at the Port of Sendai, Japan. Concrete lining on the ocean face deflects incoming waves while sloped sides allow easy access. Map inset identifies the location of berm within the Port.....	4-4
Figure 4-2	Cast-in-place reinforced concrete parking garage in Biloxi, Mississippi after Hurricane Katrina. Open structural systems allow water to pass through with minimal resistance, and interior ramps allow for easy ingress and vertical circulation	4-5
Figure 4-3	Sports complex. Designed for assembly use, this type of structure can accommodate circulation and service needs for large numbers of people	4-6
Figure 4-4	Hotel and convention complex. Meeting rooms, ballrooms, and exhibit spaces located above the tsunami inundation elevation can be used to provide areas of refuge	4-7
Figure 4-5	Residential apartment building in Kamaishi, Japan, with designated refuge area at or above the fourth level	4-7
Figure 4-6	Tsunami evacuation map for Waikiki Beach, Honolulu, Hawaii.....	4-8

Figure 5-1	Vertical evacuation refuge locations considering travel distance, evacuation behavior, and naturally occurring high ground. Arrows show anticipated vertical evacuation routes.....	5-4
Figure 5-2	Site hazards adjacent to vertical evacuation structures (numbered locations). Arrows show anticipated vertical evacuation routes.....	5-5
Figure 5-3	Illustration of requirements for minimum refuge level elevation.....	5-10
Figure 6-1	Results of Seaside, Oregon study showing the perceived effectiveness of various public education strategies	6-2
Figure 6-2	Reinforced concrete apartment building designated as a vertical evacuation structure in Minamisanriku, Japan, 2011 Tohoku tsunami.....	6-4
Figure 6-3	Roadway damage as a result of the 1964 Alaska earthquake	6-5
Figure 6-4	Vertical evacuation refuge structure at Shirahama Beach Resort, Japan, with limited capacity for storage of supplies.....	6-7
Figure 7-1	Coastal sites for site-specific tsunami inundation models for the Tsunami Forecasting System.....	7-3
Figure 7-2	ASCE Tsunami Design Geodatabase interface, showing the extent of inundation, the Tsunami Design Zone, and run-up elevation points.....	7-7
Figure 8-1	Seismic performance objectives linking building performance levels to earthquake hazard levels.....	8-8
Figure 8-2	Expected performance levels for each Tsunami Risk Category, given the Maximum Considered Tsunami hazard level	8-9
Figure 8-3	Three types of coastal inundation where the tsunami elevation (T_E) at a site of interest could be less than, equal to, or greater than the ultimate inland runup elevation (R).....	8-13
Figure 8-4	Comparison between numerical modeling and field measurement of run-up and flow elevations at Pago Pago Harbor, American Samoa.....	8-13
Figure 8-5	Hydrostatic pressure distribution and location of resultant hydrostatic force, F_h	8-14
Figure 8-6	Buoyant forces, F_b , on an overall building with watertight lower levels	8-15
Figure 8-7	Hydrodynamic force distribution and location of resultant hydrodynamic force, F_d	8-17
Figure 8-8	Waterborne debris impact force, F_i	8-18

Figure 8-9	Upward buoyant force, F_b , exerted on an elevated floor.....	8-20
Figure 8-10	Additional gravity load due to retained water, F_r , exerted on an elevated floor during rapid drawdown	8-21
Figure 8-11	Tie force strategy in a frame structure	8-25
Figure 8-12	Detailing of reinforcing steel in a beam for potential loss of a supporting column	8-25
Figure 8-13	Missing column strategy for evaluating the ability of surrounding structural components to support additional gravity loads.....	8-26
Figure 9-1	Five-story building in Kesenuma, Japan, with an exterior metal staircase installed to provide unobstructed access to the refuge area on the roof.....	9-5
Figure A-1	Location of Ocosta Elementary and Junior-Senior High Schools, Westport, Washington.....	A-1
Figure A-2	Tsunami refuge area on roof of new activities wing at Ocosta Elementary School.....	A-2
Figure A-3	Structural system details for the new activities wing and tsunami refuge structure.....	A-3
Figure A-4	Successful designated vertical evacuation building in Kesenuma Port, Japan.....	A-4
Figure A-5	Nishiki Tower in Kise, Japan.....	A-5
Figure A-6	Refuge at Shirahama Beach Resort, Japan	A-6
Figure A-7	Tsunami refuge in Kaifu, Japan	A-6
Figure A-8	Berm constructed for tsunami refuge in Aonae, Japan	A-7
Figure B-1	Hypothetical sketch of example community showing an evacuation zon, potential vertical evacuation structure sites, and evacuation routes.....	B-1
Figure B-2	Example community inundation map	B-2
Figure B-3	Example community inundation flow velocity map	B-3
Figure B-4	Example escape berm design	B-4
Figure B-5	Example escape berm plan layout.....	B-5
Figure B-6	Example escape berm section	B-5
Figure B-7	Example escape berm rear elevation.....	B-6
Figure B-8	Example covered gymnasium	B-7
Figure B-9	Example gymnasium plan.....	B-8
Figure B-10	Example gymnasium elevation.....	B-8

List of Tables

Table 2-1	Qualitative Tsunami Hazard Assessment for U.S. Locations	2-4
Table 2-2	Comparison of Relative Time and Loading Scales for Various Coastal Hazard Phenomena	2-6
Table 5-1	Tsunami Sources and Approximate Warning Times.....	5-2
Table 5-2	Maximum Spacing of Vertical Evacuation Structures Based on Ambulatory Speed and Warning Time.....	5-3
Table 5-3	Square Footage Recommendations – ICC 500-2014 <i>Standard for the Design and Construction of Storm Shelters</i>	5-8
Table 5-4	Square Footage Recommendations – FEMA P-361 <i>Design and Construction Guidance for Community Shelters</i>	5-8
Table 5-5	Square Footage Recommendations – American Red Cross Publication No. 4496.....	5-9
Table 9-1	Tsunami Load to Seismic Capacity Building Height Parity and Threshold for Selected Locations on the U.S. Pacific Coast.....	9-6
Table B-1	Design Elevations for Areas of Refuge	B-2
Table B-2	Tsunami Flow Velocity at Each Site	B-3

Tsunamis are rare events often accompanied by advance warning. As such, strategies for mitigating tsunami risk have generally involved evacuation to areas of naturally occurring high ground outside the area of tsunami inundation. Most efforts to date have focused on the development of more effective warning systems, improved inundation maps, and greater tsunami awareness to improve evacuation efficiency.

In some locations, high ground may not exist, or tsunamis triggered by local events may not allow sufficient warning time for communities to evacuate low-lying areas. In the case of tsunamis triggered by distant events, which can be accompanied by longer warning times, coastal communities can still be at risk if evacuation routes are long and complex, or become crowded with evacuees or obstructed by damage. Where horizontal evacuation out of the tsunami inundation zone is neither possible nor practical, a potential solution is vertical evacuation above rising waters into buildings and other structures with the strength and resilience necessary to resist the effects of tsunami waves. A *vertical evacuation refuge* is a structure or earthen mound designated as a place of refuge in the event of a tsunami, with sufficient height to elevate evacuees above the tsunami inundation depth, designed and constructed to resist tsunami load effects.

A Vertical Evacuation Refuge is a structure or earthen mound designated as a place of refuge in the event of a tsunami, with sufficient height to elevate evacuees above the tsunami inundation depth, designed and constructed to resist tsunami load effects.

1.1 Objectives and Scope

This report is the third edition of a report that was first published in 2008. FEMA P-646, *Guidelines for Design of Structures for Vertical Evacuation from Tsunamis* (FEMA, 2008), provided the first of its kind technical guidance and a comprehensive approach for tsunami-resistant design that was intended for vertical evacuation refuge structures. It included identification of tsunami hazards and applicable design criteria, development of methods to calculate tsunami loading, and identification of architectural and structural system attributes suitable for the design of a vertical evacuation refuge.

Following its use in conceptual design studies and ongoing research in performance-based tsunami engineering, update and revision of the first edition was deemed necessary. A second edition was published in 2012 with changes related to lessons learned from recent tsunamis, reduction in

conservatism associated with debris impact, refinement of the definition of tsunami elevation and runup elevation used in equations for tsunami load effects, and update of reference materials.

In 2011, the American Society of Civil Engineers (ASCE) Structural Engineering Institute (SEI) created a Tsunami Loads and Effects Subcommittee (TLESC) charged with the development of code provisions for tsunami design of coastal buildings and other structures. The result was a new Chapter 6, “Tsunami Loads and Effects,” which was added in the 2016 version of the ASCE/SEI 7 standard, *Minimum Design Loads and Associated Criteria for Buildings and Other Structures* (ASCE, 2016), and was adopted by reference in the 2018 edition of the *International Building Code* (ICC, 2018).

In ASCE/SEI 7-16, design provisions are applied to buildings based on assignment of Risk Category.

Tsunami design is required for structures assigned to Tsunami Risk Category IV, which includes tsunami vertical evacuation refuge structures.

Inclusion in ASCE/SEI 7-16, and adoption into the 2018 IBC, represents the first time that comprehensive tsunami design provisions have been included in building code requirements used throughout the United States. These new tsunami design provisions, however, are not applicable to all buildings. *Risk Category* is a categorization used in the determination of loads based on the risk associated with unacceptable performance. In general, buildings and other structures that represent a low risk to human life are assigned Risk Category I; standard occupancy structures are assigned Risk Category II; hazardous or otherwise important facilities are assigned Risk Category III; and essential facilities are assigned Risk Category IV.

For the purpose of tsunami design, buildings and other structures are assigned to Tsunami Risk Categories. Tsunami design is required for all structures designated as Tsunami Risk Category IV, which includes tsunami vertical evacuation refuge structures. Tsunami design is required for Tsunami Risk Category III structures where inundation depths exceed 3 feet (0.914 m), and Tsunami Risk Category II structures only where designated by local statute.

FEMA P-646 Third Edition. This third edition has been developed to serve as a guide for community resource planning related to vertical evacuation, and to provide additional background, guidance, and commentary on the technical design provisions now contained in ASCE/SEI 7-16.

Many of the design provisions contained in prior editions of this report have been augmented or replaced by provisions in ASCE/SEI 7-16. To avoid potential conflict, this third edition has been developed to serve as a guide for community resource planning related to vertical evacuation, and to provide additional background, guidance, and commentary on the technical design provisions now contained in ASCE/SEI 7-16.

This report is intended as a resource for state and local government officials, community planners, engineers, architects, building officials, emergency managers, tsunami planning activists, and building owners who are

considering the construction and operation of tsunami-resistant structures that are intended to provide a safe haven for evacuees during short-term, high-risk tsunami events. It provides guidance on the planning, location, operation, design, and construction of structures that could be used as a refuge for vertical evacuation above rising waters associated with tsunami inundation. Much of the information contained in a report originally published as a companion to the first edition, FEMA P-646A, *Vertical Evacuation from Tsunamis: A Guide for Community Officials* (FEMA, 2009) has now been incorporated directly into this third edition.

1.2 Tsunami Refuge Versus Shelter

It is important to note that a refuge is not the same as a shelter. A refuge is an evacuation facility that is intended to serve as a safe haven until an imminent danger has passed. In the case of tsunamis, a refuge is meant to serve for a few hours until the danger of tsunami waves has passed. In most areas, damaging waves will occur within the first 12 hours after the triggering event, although the potential for abnormally high tides and coastal flooding can last as long as 24 hours.

In contrast, a shelter is a longer-term evacuation facility, such as a Red Cross shelter, which is intended to provide safe, accessible, and secure short-term housing for disaster survivors, typically including a place to sleep along with extended food and water supplies.

A vertical evacuation refuge can serve as a shelter, if it is appropriately sized, adequately stocked with provisions, and operated as such. Similarly, a shelter can serve as a vertical evacuation refuge if it is designed and constructed to meet the necessary tsunami-resistant design criteria.

1.3 Tsunami Hazard Versus Risk

Hazard is related to the potential for an event to occur, while risk is related to consequences, given the occurrence of an event. Tsunami hazard is a measure of the potential for a tsunami to occur at a given site. It is also a measure of the potential magnitude of site-specific tsunami effects, including extent of inundation, height of runup, flow depth, and velocity of flow.

Tsunami risk is a measure of the consequences given the occurrence of a tsunami, which can be characterized in terms of damage, loss of function, injury, and loss of life. Tsunami risk depends on many factors including the vulnerability of the built environment, population density, warning times, and the ability to evacuate inundation zones.

A refuge is an evacuation facility that is intended to serve as a safe haven until an imminent danger has passed (e.g., a few hours).

A shelter is an evacuation facility that is intended to provide safe, accessible, and secure short-term housing for disaster survivors, typically including a place to sleep along with extended food and water supplies.

Tsunami Hazard is a measure of the potential for a tsunami to occur at a given site.

Tsunami Risk is a measure of the consequences given the occurrence of a tsunami, which can be characterized in terms of damage, loss of function, injury and loss of life.

Similar to other hazards (e.g., earthquake and wind) design criteria for tsunami effects are based on the magnitude of the tsunami hazard.

1.4 Reasons to Construct a Vertical Evacuation Refuge Structure

Reasons to construct a vertical evacuation refuge structure are based on the real or perceived risk to a local population resulting from exposure to tsunami hazard. Where the risk to a coastal community is deemed to be unacceptably high, vertical evacuation can be a possible solution for mitigating tsunami risk. Many factors influence the decision to construct a vertical evacuation refuge, including:

- the likelihood of a region being affected by a tsunami event;
- a lack of nearby, available high ground;
- inability of a population to get to high ground or evacuate an area of potential tsunami inundation;
- the potential consequences of a tsunami event (e.g., damage, injury, and loss of life);
- the elements of a local emergency response plan, including available evacuation alternatives;
- the planned and potential uses for a refuge facility; and
- the cost of constructing a tsunami-resistant structure.

Based on the assessed tsunami hazard and a review of potential resources in a region, decisions can be made as to whether or not vertical evacuation is needed, what capacity for evacuation is necessary, where evacuation options should be located, and what type of structure should be built or designated as refuge. These decisions must be based on the conditions specific to each location, with the need for vertical evacuation prioritized in relation to other needs in the region.

1.5 Limitations

This document is a compilation of the best information available at the time of publication. It is intended to provide specific recommendations for planning, designing, constructing, and operating tsunami vertical evacuation refuge structures, once the decision has been made to build such a structure.

It is not intended to replace existing local tsunami evacuation policies and procedures, or to supersede current codes and standards. Nor is it intended to mandate, or imply, that all structures in tsunami hazard areas should be made

tsunami-resistant using these criteria, as such a decision would be cost-prohibitive, especially in the case of light-frame residential structures.

Large damaging tsunamis are rare events, and existing knowledge is based on limited historic information. Coastal inundation patterns are based on complex interactions among many parameters, and are highly uncertain. Multiple design assumptions are required, including the intensity of a local earthquake that could threaten a structure prior to a tsunami, the flow depths and velocities of the design tsunami at a site, and the type of waterborne debris that may occur at a site.

Development of the ASCE/SEI 7-16 tsunami design provisions included an appropriate level of conservatism in estimating tsunami loads and effects, and in incorporating uncertainties in the development of Tsunami Design Zone (TDZ) maps. A reliability study by Chock, et al. (2016) estimated the probability of failure of a vertical evacuation refuge structure designed in accordance with ASCE/SEI 7-16 to be less than 1% given the occurrence of a Maximum Considered Tsunami event. Although vertical evacuation structures designed in accordance with ASCE/SEI 7-16 would be expected to safely resist the effects of a tsunami, it should be understood that proportioning a structure for a design tsunami event does not necessarily mean the structure will be able to resist every possible tsunami event.

Critical to the design of a vertical evacuation structure is the height of the area of refuge above the anticipated tsunami inundation depth. Even if the structure survives the inundation, overtopping of the refuge area will result in unacceptable loss of life for those who sought refuge in the designated area. Conservative assumptions should be made in all aspects of design when structures are expected to provide safety and security to a significant portion of the population, especially when hazards are highly uncertain.

Conservative assumptions should be made in all aspects of design when structures are expected to provide safety and security to a significant portion of the population, especially when hazards are highly uncertain.

1.6 Organization and Content

This third edition serves the dual purpose of providing information for both technical and lay audiences. Information to assist in planning, funding, locating, operating, and maintaining vertical evacuation refuge structures is provided in the first six chapters of this report. Information providing additional background, guidance, and commentary on the technical design provisions now contained in ASCE/SEI 7-16 is provided in the last three chapters of this report. Information has been organized as follows:

Chapter 1 defines the objectives, scope, and limitations of information provided in this report.

Chapter 2 describes the tsunami threat and demonstrates the feasibility of vertical evacuation as alternative to evacuation by providing background information on historic tsunami effects and their observed impacts on buildings in coastal communities.

Chapter 3 provides guidance on planning for tsunami response and considering the use of vertical evacuation strategies, including details associated with planning, permitting, constructing, and funding vertical evacuation solutions.

Chapter 4 describes vertical evacuation considerations, presents different options for vertical evacuation solutions, and provides guidance for choosing among the various alternatives.

Chapter 5 provides guidance on siting, spacing, sizing, and elevation considerations for the distribution of vertical evacuation refuge structures throughout a community.

Chapter 6 describes operational and maintenance considerations for vertical evacuation refuge structures.

Chapter 7 describes the characterization of tsunami hazard, including tsunami modeling and inundation mapping, and the availability of tsunami inundation parameters for use in design.

Chapter 8 describes the historical basis for calculation of tsunami load effects, and provides additional guidance and commentary on ASCE/SEI 7-16 tsunami design provisions.

Chapter 9 outlines special considerations for the use of existing buildings as tsunami vertical evacuation refuge structures.

Appendices A and B provide supplemental information, including additional examples of vertical evacuation structures used in the United States and Japan, and an illustration of siting and spacing criteria applied to a community design example.

A Glossary defining terms used throughout this document, and a list of References identifying resources for additional information, are also provided at the end of this report.

Background on Historic Tsunami Effects

Although considered rare events, tsunamis occur on a regular basis around the world. Each year, on average, there are 20 tsunami-genic earthquake events, with five of these large enough to generate tsunami waves capable of causing damage and loss of life. In the period between 2000 and 2018 there were 218 tsunamis reported, 20 of which resulted in fatalities, and three of which that resulted in more than 2,000 fatalities. With the trend toward increased habitation of coastal areas, more populations will be exposed to tsunami hazard.

This chapter provides background information on historic tsunami effects and impacts on buildings in coastal communities. Lessons from past observations are used to demonstrate the feasibility of vertical evacuation as a viable alternative, and to draw implications for tsunami-resistant design.

2.1 Categorization, Behavior, and Characteristics of Tsunamis

Tsunami is a Japanese word meaning “harbor” (tsu) and “wave” (nami). The term was created by fishermen who returned to port to find the area surrounding the harbor devastated. It is a naturally occurring series of waves that can result when there is a rapid, large-scale disturbance of a body of water. The most common triggering events are earthquakes below or near the ocean floor, but a tsunami can also be created by volcanic activity, landslides, undersea slumps, and impacts of extra-terrestrial objects. The waves created by this disturbance propagate away from the source. In deep water, high velocity waves have gentle sea-surface slopes that can be unnoticeable. As the waves approach the shallower waters of the coast, however, the velocity decreases while the height increases. Upon reaching the shoreline the waves can have hazardous height and velocity, penetrating inland, damaging structures, and flooding normally dry areas.

Tsunamis are categorized by the location of the triggering event and the time it takes the waves to reach a given site. The Tsunami Glossary (UNESCO/IOC, 2016) defines technical terms and tsunami warning center products and forecast services that are generally provided by warning

A Tsunami is a naturally occurring series of ocean waves resulting from a rapid, large-scale disturbance in a body of water, caused by earthquakes, landslides, volcanic eruptions, and meteorite impacts.

Tsunamis are categorized by the location of the triggering event and the time it takes the waves to reach a given site.

centers. In the Tsunami Glossary, a far-source-generated tsunami (also known as a distant or tele-tsunami) is one that originates from a source that is far away from the site of interest, and takes three hours or longer after the triggering event to arrive. The originating earthquake or landslide will not be felt before the first wave arrives, so the warning will come from one of the two U.S. tsunami warning centers.

The National Tsunami Warning Center (NTWC) located in Palmer, Alaska, is responsible for issuing tsunami alerts for Alaska, the continental U.S. Pacific, Atlantic and Gulf of Mexico coasts, and the Pacific and Atlantic Coasts of Canada. The Pacific Tsunami Warning Center (PTWC) located in Pearl Harbor, Hawaii, is responsible for issuing tsunami alerts for Hawaii, American Samoa, Guam, the Commonwealth of the Northern Mariana Islands, Puerto Rico, the U.S. and British Virgin Islands. It also provides tsunami threat information to countries bordering the Pacific Ocean and its Marginal Seas (except Canada), and the Caribbean and Adjacent Seas. Each country then uses the PTWC information to guide their own tsunami warning issuance. For U.S. States, Territories, and Commonwealths, tsunami warnings will generally give a population time to evacuate to safe high ground, but the tsunami can still cause significant damage. In the December 2004 Indian Ocean tsunami, Sri Lanka suffered major damage despite being located 1,000 miles from the earthquake that triggered the tsunami.

A mid-source-generated (or regional) tsunami is one in which the source is somewhat closer to the site of interest, but not close enough for the effects of the triggering event to be felt at the site. Mid-source-generated tsunamis would be expected to arrive between 1 hour and 3 hours after the triggering event. The tsunami warning center can give a timely warning that needs to be responded to almost immediately in order to provide enough time for evacuation. In general, a community at risk from mid-source-generated tsunamis should use the same considerations as those at risk from a near-source-generated tsunami, and steps should be taken to ensure that all areas of a community can evacuate within 60 minutes.

A near-source-generated (or local) tsunami is one that originates from a source that is close to the site of interest, and can arrive in one hour or less. Sites experiencing near-source-generated tsunamis will generally feel the effects of the triggering event (e.g., shaking caused by a near-source magnitude 7.0 or larger earthquake). The earthquake-induced ground shaking serves as a warning for people to evacuate immediately to high ground or to a designated vertical evacuation refuge. There may be insufficient time to wait for an official warning from the tsunami warning center before starting evacuation. For example, the 1993 tsunami that hit

According to the Tsunami Glossary:

A far-source-generated (distant) tsunami is one that originates from a source that is far away from the site of interest, and takes 3 hours or longer after the triggering event to arrive.

A mid-source-generated (regional) tsunami is one in which the source is somewhat close to the site of interest, and arrives between 1 hour and 3 hours after the triggering event.

A near-source-generated (local) tsunami is one that originates from a source that is close to the site of interest, and arrives within 1 hour of the triggering event. The effects of the triggering event may also be felt at the site.

Okushiri, Hokkaido, Japan, reached the shoreline within 5 minutes after the earthquake, and resulted in 208 fatalities.

2.1.1 Historic Tsunami Activity

The combination of a great ocean seismic event with the right bathymetry can have devastating results, as was brought to the world's attention by the Indian Ocean tsunami of December 26, 2004, and more recently, the Tohoku Japan tsunami of March 11, 2011. The Indian Ocean tsunami was created by a magnitude 9.1 earthquake and devastated coastal areas around the northern Indian Ocean. The tsunami took anywhere from 15 minutes to more than 11 hours to hit the various coastlines it affected. It is estimated that the tsunami took nearly 230,000 lives and displaced over 1.5 million people. The Tohoku Japan tsunami was generated by the magnitude 9.1 Great East Japan earthquake and led to inundation heights along the coast of the main Japanese island of Honshu that equaled or exceeded historical records for inundation in the region. Breakwater and seawall defensive systems were overtopped or destroyed in almost all communities along the Tohoku coastline, leading to over 18,000 missing or dead, and extensive damage to ports, buildings, bridges and other coastal infrastructure.

Data for all historic tsunami activity can be found in the National Oceanic and Atmospheric Administration (NOAA), National Centers for Environmental Information (NCEI), World Data Service (WDS), *NCEI/WDS Global Historical Tsunami Database, 2100 BC to Present* (NOAA/NCEI, 2018).

Relative tsunami hazard can be characterized by the distribution and frequency of recorded runups. Table 2-1 provides a qualitative assessment of tsunami hazard for regions of the United States that are threatened by tsunamis, as characterized by the National Oceanic and Atmospheric Administration (NOAA) and the U.S. Geological Survey (USGS) using the historical tsunami record and earthquake probabilities (Dunbar and Weaver, 2015).

Alaska, Hawaii, and the U.S. West Coast are considered to have high to very high potential for tsunami-generating events in the United States. Puerto Rico and the U.S. Virgin Islands, Guam, and the Northern Mariana Islands, and American Samoa have high potentials, while the U.S. Atlantic Coast, U.S. Gulf Coast, and Alaska Arctic Coast have the lowest potential.

Alaska, Hawaii, and the U.S. West Coast are considered to have high to very high potential for tsunami-generating events.

The subduction zone, particularly in the vicinity of the Alaskan Peninsula, the Aleutian Islands, and the Gulf of Alaska have the capability of generating tsunamis that affect both local and distant sites. The 1964 earthquake in

Prince William Sound resulted in 124 fatalities, including 13 in California and 5 in Oregon. In 1994 a landslide-generated tsunami in Skagway Harbor resulted in one death and \$25 million in property damage.

Table 2-1 Qualitative Tsunami Hazard Assessment for U.S. Locations, (Dunbar and Weaver, 2015)

Region	Hazard Based on Historical Record and Earthquake Probabilities	Number of Reported Deaths
Alaska	High to Very High	222
Alaska Arctic Coast	Very Low	None
American Samoa	High	34
Guam and Northern Mariana Islands	High	1
Hawaii	High to Very High	293
Puerto Rico and U.S. Virgin Islands	High	164
U.S. Atlantic Coast	Very Low to Low	None
U.S. Gulf Coast	Very Low	None
U.S. West Coast	High to Very High	25*

* Excludes any deaths caused by the 1700 Cascadia tsunami on the U.S. West Coast.

The Cascadia subduction zone along the Pacific Northwest coast poses a threat from northern California to British Columbia, Canada. An earthquake along the southern portion of the Cascadia subduction zone could create tsunami waves that would hit the coasts of Humboldt and Del Norte counties in California and Curry County in Oregon within a few minutes of the earthquake. Areas further north, along the Oregon and Washington coasts, could see tsunami waves within 20 to 40 minutes after a large earthquake. Prehistoric data based on paleo-tsunami studies and tsunami modeling indicate that the Cascadia subduction zone could generate tsunamis approaching the destructive power of the 2004 Indian Ocean tsunami (Priest et al., 2008). The last event of this kind was caused by an estimated magnitude 9.0 earthquake on the Cascadia subduction zone on January 26, 1700. The resulting tsunami left a record of widespread destruction in Japan (Satake et al., 2003).

The destructive 2009 Samoa tsunami demonstrated that all subduction zones should be considered capable of generating damaging waves, and that the available historical and instrumental record does not necessarily capture the true hazard. Prior to this tsunami, observed runups in American Samoa had been less than 3 meters and most runups were less than 0.3 meters, but in 2009, many sites experienced runups in excess of 3 meters. In American

Samoa, the average runup heights were 4 meters with a maximum of nearly 18 meters at Poloa, Tutuila Island. The tsunami caused 34 deaths and \$126 million in damage in American Samoa. As a result, all U.S. Pacific Islands located in subduction zones, including American Samoa, Guam, and the Northern Mariana Islands, warrant a High tsunami hazard assessment.

Communities along the entire U.S. Pacific coastline are at risk for far source-generated (trans-Pacific) tsunamis and locally triggered tsunamis. In southern California there is evidence that movement from local offshore strike-slip earthquakes and submarine landslides have generated tsunamis affecting areas extending from Santa Barbara to San Diego. The largest of these occurred in 1930, when a magnitude 5.2 earthquake reportedly generated a 6-meter (20-foot) wave in Santa Monica, and 3-meter (10-foot) runups in Santa Monica and Venice, California (CGS, 2006; NOAA/NCEI, 2018).

Hawaii, located in the middle of the Pacific Ocean, has experienced both far-source-generated tsunamis and locally triggered tsunamis. The far-source 1946 Aleutian tsunami swept across the Pacific Ocean and caused damage in Hawaii, killing 159 people in Hilo, and causing property damage estimated to be over \$26 million in 1946 dollars. Paleo-tsunami deposits on the Island of Kauai have been linked to a much larger tsunami originating from a similar region of the central Aleutian Island chain (Butler, et al. 2014). In 1960, a magnitude 9.5 earthquake in Chile generated another tsunami that hit Hilo. Sixty-one people died and damage was estimated at \$24 million in 1960 dollars (Pararas-Carayannis, 1968). The 2011 Tohoku Japan tsunami resulted in inundation of a number of coastal communities in Hawaii, causing structural and nonstructural damage to homes, hotels and small boat harbors. Total damages were estimated at \$40 million. The most recent damaging near-source-generated tsunami in Hawaii occurred in 1975, the result of a magnitude 7.7 earthquake off the southeast coast of the island of Hawaii. This earthquake resulted in tsunami wave heights of more than 6 meters (20 feet) and, in one area, more than 14 meters (47 feet). Two deaths and more than \$1.5 million in property damage were attributed to this local Hawaiian tsunami (Pararas-Carayannis, 1976; NOAA/NCEI 2018).

Although the Atlantic and Gulf Coast regions of the United States are perceived to be at less risk, there are examples of deadly tsunamis that have occurred in the Atlantic Ocean. Since 1600, more than 40 tsunamis and tsunami-like waves of varying intensity have been cataloged in the eastern United States. In 1929, a tsunami generated in the Grand Banks region of Canada hit Nova Scotia, killing 28 people (Lockridge et al., 2002).

Although the Atlantic and Gulf Coast Regions of the United States are perceived to be at less risk, there are examples of deadly tsunamis that have occurred in the Atlantic Ocean.

Puerto Rico and the U.S. Virgin Islands are at risk from earthquakes and underwater landslides that could occur in the Puerto Rico Trench subduction zone. Since 1530, more than 90 tsunamis of varying intensity have occurred in the Caribbean, of which 13 were observed in Puerto Rico and the Virgin Islands. In 1918, an earthquake in this zone generated a tsunami that caused an estimated 140 deaths in Puerto Rico. In 1867, an earthquake-generated local tsunami caused damage and 24 deaths on the islands of Saint Thomas and Saint Croix in the U.S. Virgin Islands. In 1692 a tsunami generated by massive landslides in the Puerto Rican Trench reached the coast of Jamaica, causing an estimated 2,000 deaths (Lander, 1999).

2.1.2 Behaviors and Characteristics of Tsunamis

Information from historic tsunami events indicates that tsunami behavior and characteristics are quite distinct from other coastal hazards, and often cannot be inferred from common knowledge or intuition. The primary reason for this distinction is the unique timescale associated with tsunami phenomena. Unlike typical wind-generated water waves with periods between 5 and 20 seconds, tsunamis can have wave periods ranging from a few minutes to over 1 hour (FEMA, 2011). This timescale is also important because of the potential for wave reflection, amplification, or resonance within coastal features. Table 2-2 compares various coastal hazard phenomena.

Tsunami wave periods can range from a few minutes to over 1 hour, resulting in an increased potential for reflection, amplification, or resonance within coastal features.

Table 2-2 Comparison of Relative Time and Loading Scales for Various Coastal Hazard Phenomena

Coastal Hazard Phenomenon	Time scale (Duration of Loading)	Loading Scale (Height of Water)	Typical Warning Time
Wind-Generated Waves	Tens of seconds	1 to 2 meters typical	Days
Tsunami Runup	Minutes to hours	1 to Tens of meters	Several minutes to hours
Hurricane Storm Surge	Several hours	1 to 10 meters	Several hours to a few days
Earthquake Shaking	Seconds	N/A	Seconds to none

There is significant uncertainty in the prediction of hydrodynamic characteristics of tsunamis because they are highly influenced by the tsunami waveform and the surrounding topography and bathymetry. Although there are exceptions, previous research and field surveys indicate that tsunamis have the following general characteristics:

- The moment magnitude and slip of the triggering event determines the period of the resulting waves, and generally (but not always) the tsunami height and damage potential (FEMA, 2011).

- A tsunami can propagate more than several thousand kilometers without losing energy.
- Tsunami energy propagation has strong directivity. The majority of its energy will be emitted in a direction normal to the major axis of the tsunami source. The more elongated the tsunami source, the stronger the directivity (Okal, 2003; Carrier and Yeh, 2005). Direction of approach can affect tsunami characteristics at the shoreline, because of the sheltering or amplification effects of other land masses and offshore bathymetry (FEMA, 2011). A numerical example of the propagation of the 2004 Indian Ocean tsunami is shown in Figure 2-1.

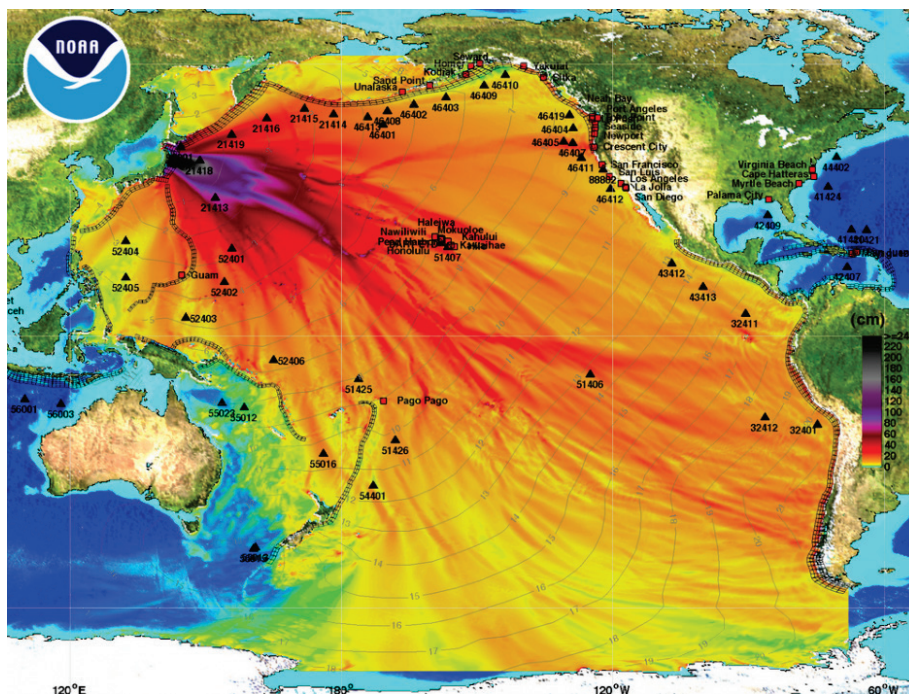

Figure 2-1 Maximum computed offshore tsunami amplitudes (in centimeters) in the Pacific Ocean for the 2004 Indian Ocean tsunami (NOAA Center for Tsunami Research, <http://nctr.pmel.noaa.gov/honshu20110311>).

- At the source, a tsunami waveform contains a wide range of wave components, from short to long wavelengths. Long wave components propagate faster than short wave components; therefore, shorter wave components are left behind and attenuated by radiation and dispersion. A transoceanic tsunami is therefore usually characterized by a series of long-period waves (several to tens of minutes).
- For a locally-generated tsunami, the leading wave is often a receding water level followed by an advancing positive heave (an elevation wave). This may not be the case, however, if the coastal ground subsides by co-seismic displacement. Figure 2-2 schematically illustrates the pattern of

a receding water level followed by an elevation wave for a local subduction-type earthquake. The figure also depicts how the coastal ground may subside when the rupture occurs near the shoreline.

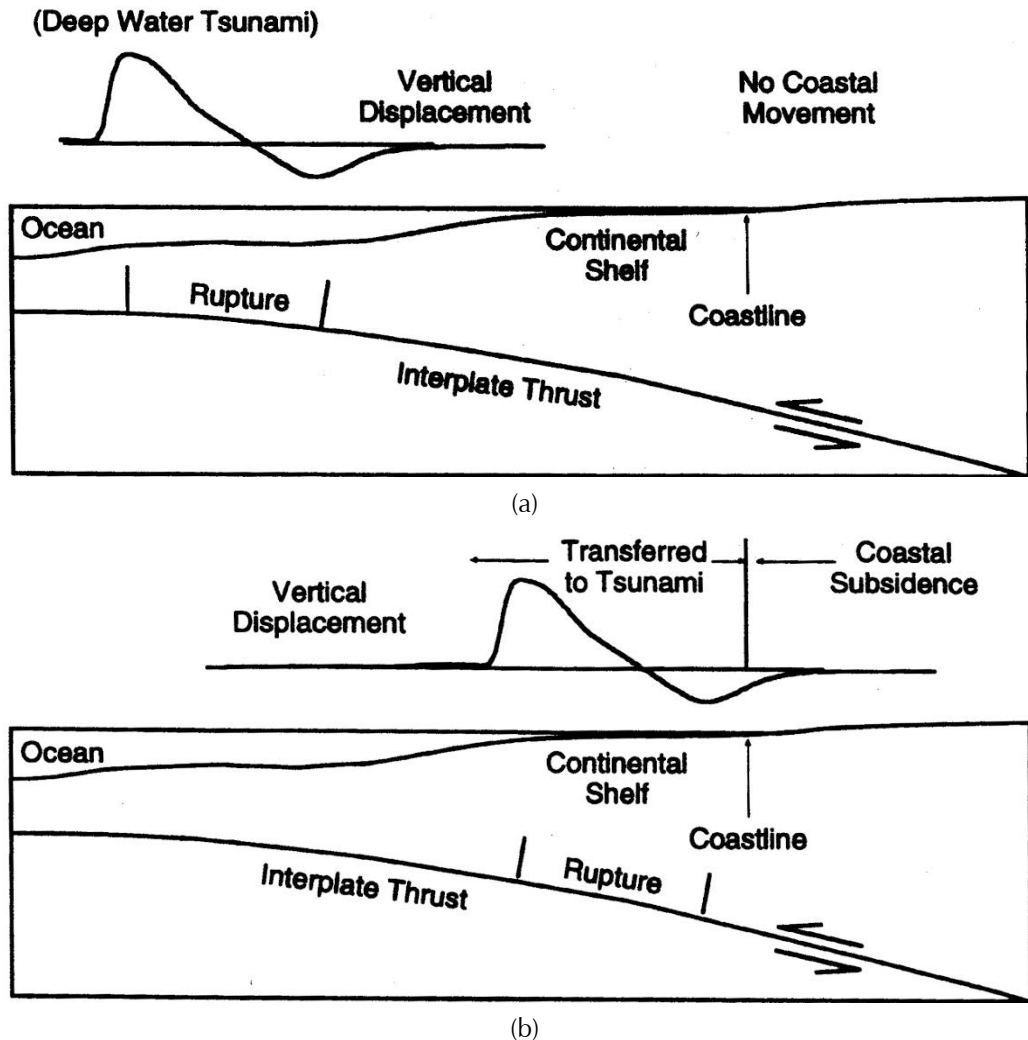
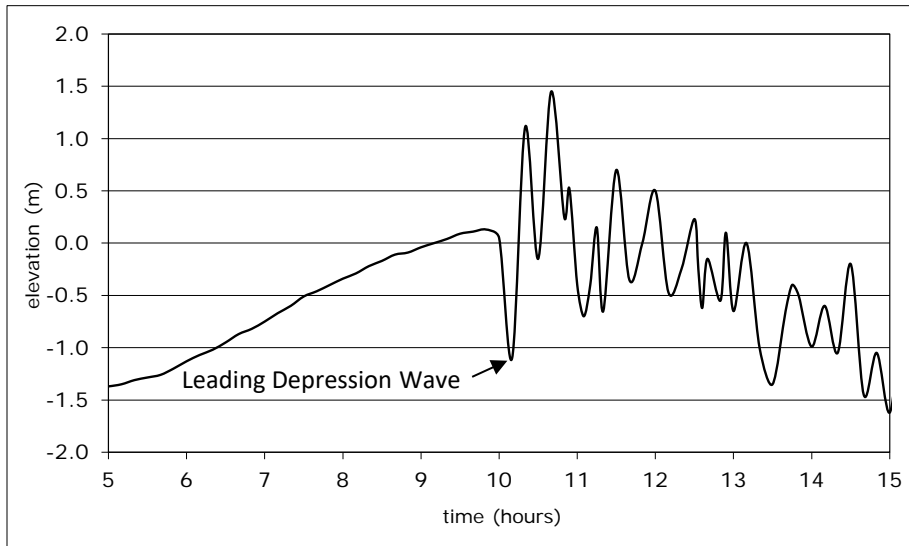

Figure 2-2 Schematic diagrams of the vertical displacement resulting from subduction-type fault dislocation: (a) rupture zone located far offshore; and (b) rupture zone adjacent to coastline with coastal subsidence (Geist, 1999).

- For a far-source-generated tsunami, the leading wave is often an elevation wave when it reaches the far shore. Figure 2-3 contrasts leading waves at near sites and distant sites during the 2004 Indian Ocean tsunami, showing a leading depression wave measured at a tide gage station in Thailand (near site) versus a leading elevation wave measured at the southern end of India (distant site).
- Tsunamis are highly reflective at the shore, and capable of sustaining their motion for several hours without dissipating energy. Typically, several tsunami waves will impact a coastal area, and the first wave is

not necessarily the largest. Sensitive instrumentation can detect tsunami activity for several days.



(a)

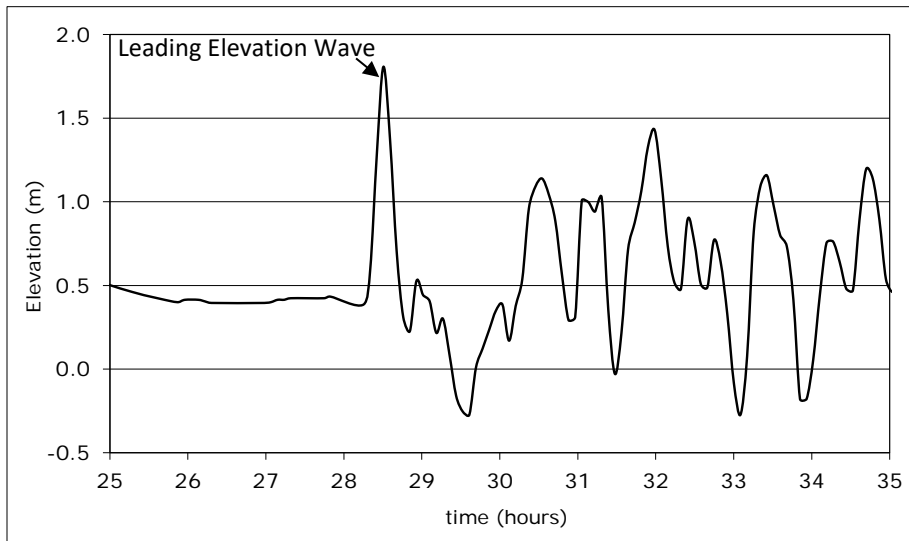

(b)

Figure 2-3 Contrasting tide gage records (in meters) for the 2004 Indian Ocean tsunami at: (a) Ta Phao Noi, Thailand, showing the leading depression wave at a near site; and (b) Tuticorin, India, showing the leading elevation wave at a distant site.

- Tsunami runup heights vary significantly in adjacent areas along a coastline. The configuration of the continental shelf and shoreline affect tsunami impacts at the shoreline through wave reflection, refraction, and shoaling. Variations in offshore bathymetry and shoreline irregularities can focus or disperse tsunami wave energy along certain shoreline reaches, increasing or decreasing tsunami impacts (FEMA, 2011).

Tsunami runup heights vary significantly in neighboring areas due to variations in offshore bathymetry that can increase or decrease local tsunami impacts.

Figure 2-4 shows significant variation in runup heights measured along the northwest coastline of Okushiri Island in the 1993 Okushiri tsunami.

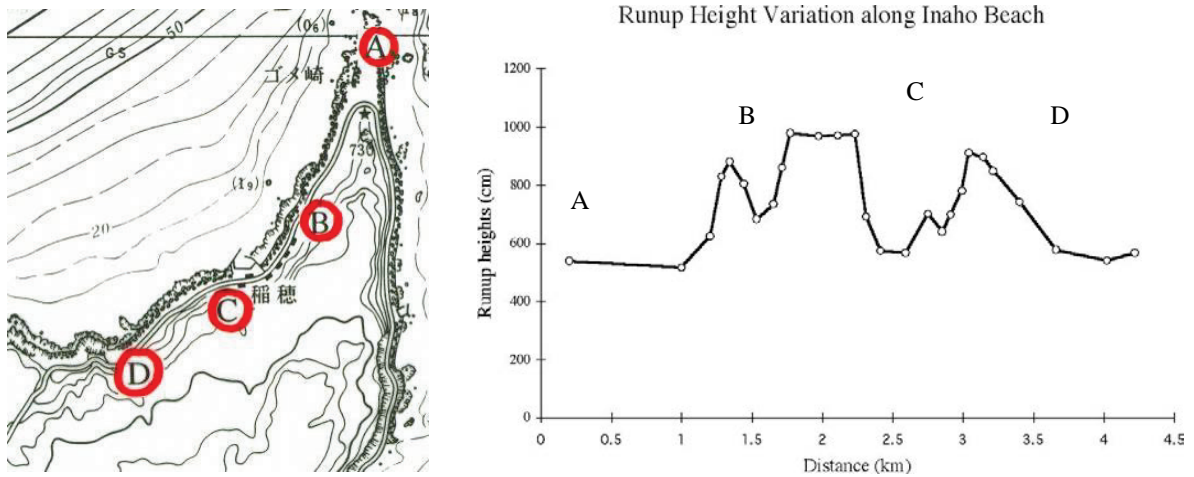

Figure 2-4 Measured runup heights in the 1993 Okushiri tsunami along Inaho Coast, Japan, demonstrating that runup height varies significantly between neighboring areas.

- The majority of eyewitness accounts and visual records (videos and photographs) indicate that a tsunami will break offshore forming a bore or a series of bores as it approaches the shore. A turbulent bore is defined as a broken wave having a steep, violently foaming and turbulent wave front, propagating over still water of a finite depth, as shown in Figure 2-5. These broken waves (or bores) are considered relatively short waveforms (although still longer than wind-generated waves) riding on a much longer main heave of the tsunami. Such bore formations were often observed in video footage of the 2004 Indian Ocean tsunami and the 2011 Tohoku Japan tsunami.

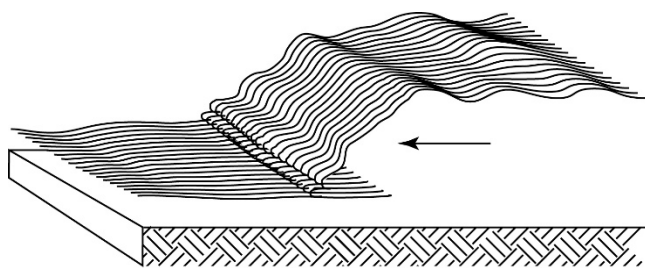

Figure 2-5 Sketch of a bore and photo from the 1983 Nihonkai-Chubu tsunami showing the formation of a bore offshore (photo from Knill and Knill, 2004).

- After a bore reaches the shore, the tsunami rushes up on dry land in the formation of a surge, as shown in Figure 2-6. In some cases, especially when a long-wavelength, leading-elevation, far-source-generated tsunami inundates land on a steep slope, the runup can be characterized as a gradual rise and fall of water (i.e., surge flooding) as shown in Figure 2-7. The impact of the 1960 Chilean tsunami at some Japanese localities and the 1964 Alaska tsunami at the town of Port Alberni, Canada are classic examples of surge flooding.

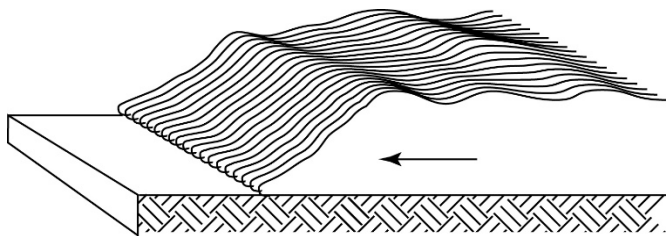

Figure 2-6 Sketch of a surge and photo from the 1983 Nihonkai-Chubu tsunami showing the formation of a surge (photo courtesy of N. Nara).

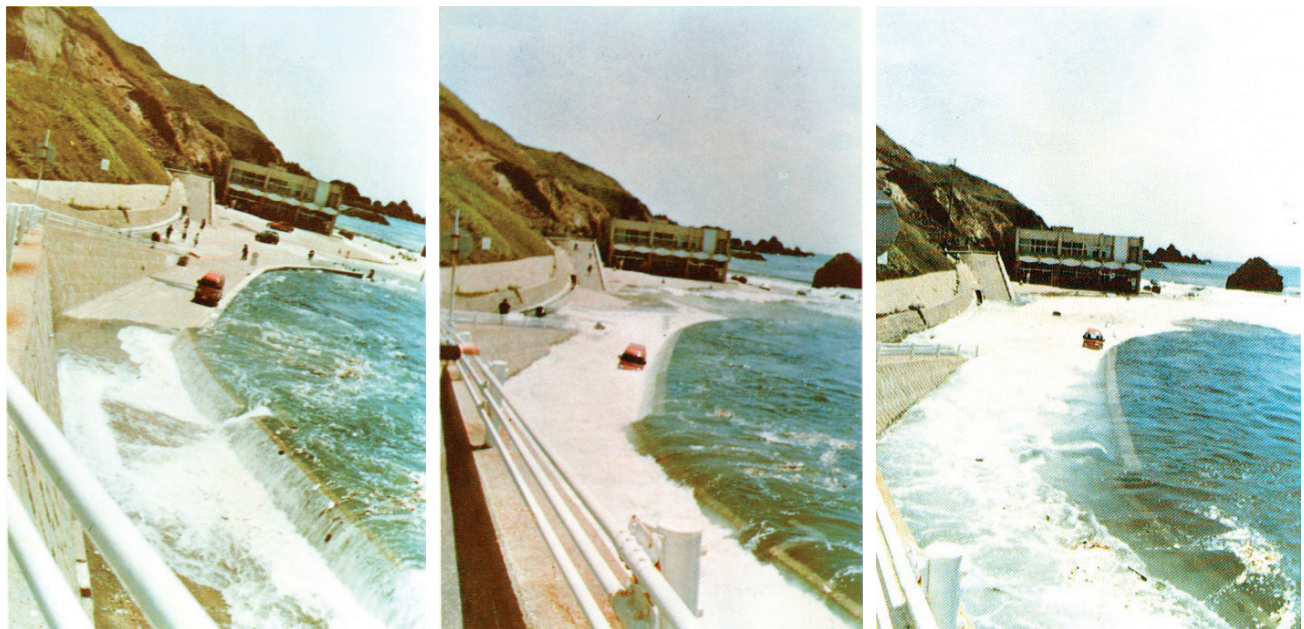

Figure 2-7 A sequence of photos from the 1983 Nihonkai-Chubu tsunami showing surge flooding from tsunami runup (photo courtesy of S. Sato).

2.2 Tsunami Effects on Buildings

Damage studies from historic tsunami events, including the 2004 Indian Ocean tsunami and the 2011 Tohoku Japan tsunami, and studies of storm surge

There are numerous examples of mid- to high-rise engineered structures that have survived coastal inundation.

associated with Hurricane Katrina in 2005, have provided information on the response of the built environment to devastating tsunamis and coastal flooding. Although there is considerable damage to, and often total destruction of, residential and light-framed buildings during extreme coastal flooding, there are also numerous examples of mid- to high-rise engineered structures that survived coastal inundation.

Structural damage from tsunamis can be attributed to: (1) direct hydrostatic forces (induced by a standing mass of water) and hydrodynamic forces (induced by flow of water) associated with inundation; (2) impact forces from water-borne debris; (3) fire spread by floating debris and combustible liquids; (4) scour and slope/foundation failure; and (5) wind forces induced by wave motion. Tsunami load effects are described in Chapter 8.

2.2.1 Historic Data on Tsunami Effects

Studies of damage from historic tsunamis have shown that building survivability varies with construction type and tsunami runup height (Yeh et al., 2005). Figure 2-8 shows data on damage for various types of construction resulting from the 1993 Okushiri tsunami and earlier tsunamis.

For a given tsunami height, wood frame construction experienced considerably more damage and was frequently destroyed, while reinforced concrete structures generally sustained only minor structural damage. Recent data, including those of the 2004 Indian Ocean tsunami, support this conclusion.

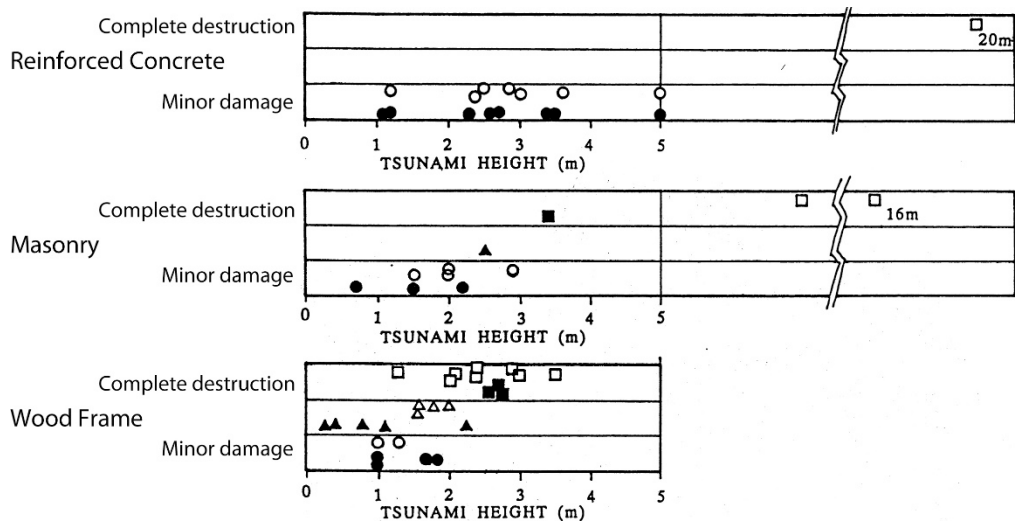

Figure 2-8 Degrees of building damage versus tsunami runup height. Marks filled in black are data from the 1993 Okushiri tsunami; hollow marks are data from previous tsunami events (adapted from Shuto, 1991, Yeh, et al., 2005).

Note that the total destruction of one concrete structure is identified in Figure 2-8. This structure was the lighthouse at Scotch Cap, Unimak Island. The Scotch Cap lighthouse is shown in Figure 2-9, before and after the 1946 Aleutian tsunami. There is some question as to how well the lighthouse was constructed, but it is possible that its destruction was the result of a wave breaking directly onto the structure, which was located right at the shoreline. The breaking wave could have been equivalent to a “collapsing” breaker, one of the classifications of wave breakers used in coastal engineering (Wiegel, 1964) that occurs at shorelines with steeply sloping beaches.

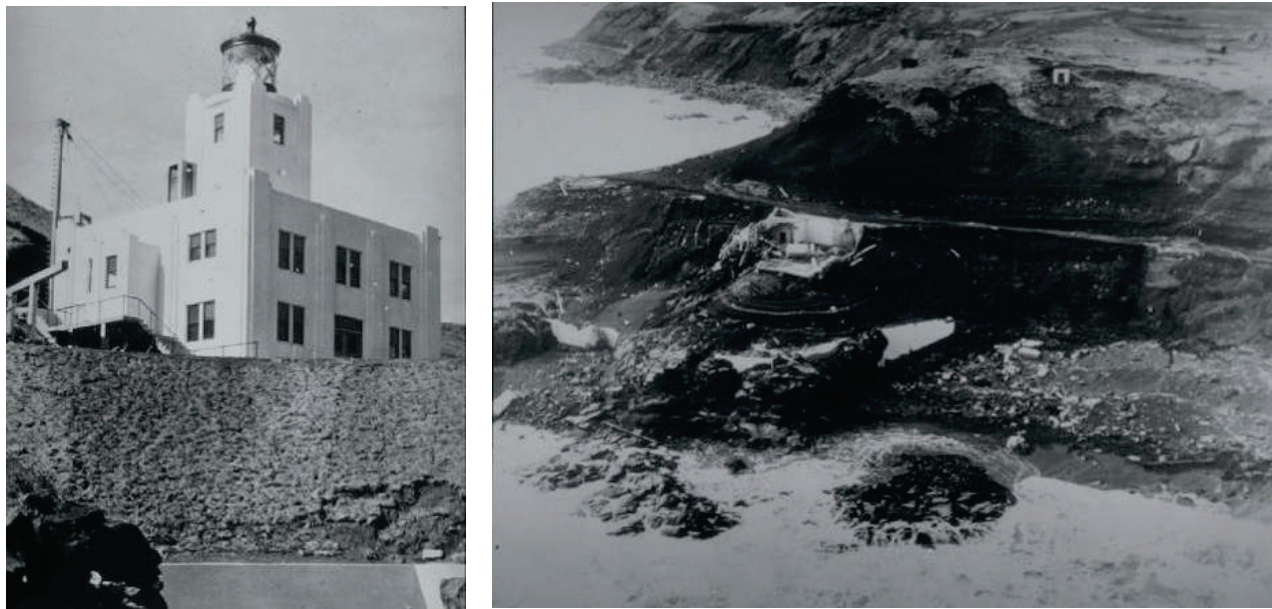

Figure 2-9 Scotch Cap Lighthouse destroyed by the 1946 Aleutian tsunami (NOAA/NGDC, 2008).

The 1993 Okushiri tsunami completely destroyed the entire town of Aonae. Figure 2-10 shows bare concrete foundations typically observed as remnants of wood-frame residential construction after a tsunami.

The 1992 Nicaragua tsunami provided other examples of variations in the performance of different structures. Figure 2-11 shows severe scour and complete destruction of a grade-level wood-frame house (left), and survival of an elevated wood frame and a grade-level rigid masonry structure (right). All three houses were located on a beach berm in the same vicinity, less than 200 meters apart.

Building failures have been observed when waterborne debris traveling at significant speeds impacts buildings. An example of the destruction caused by the impact of water-borne debris from the 1993 Okushiri tsunami is shown in Figure 2-12. The debris in this case was a fishing boat that had broken free from its moorings. Waterborne debris is also known to collect



Figure 2-10 Total destruction of a group of wood-frame houses in Aonae Village, Okushiri Island, Japan, 1993 Okushiri tsunami (photo courtesy of H. Yeh).



Figure 2-11 Beach houses with varying levels of damage in El Popoyo, Nicaragua, 1992 Nicaragua tsunami (photos courtesy of H. Yeh).

between structural supports creating a barrier that can significantly increase hydraulic forces on the building.

In contrast to the many failures reported as a result of past tsunamis, many structures have been observed to survive tsunami inundation. Two structures that survived the 1993 Okishiri tsunami are shown in Figure 2-13. Both are two-story reinforced concrete structures, and both were inundated by at least 3 meters of water.



Figure 2-12 Damage caused by impact from water-borne debris (fishing boat) in Aonae, Japan, 1993 Okushiri tsunami (photo courtesy of J. Preuss).



Figure 2-13 Examples of reinforced concrete structures that survived the 1993 Okushiri tsunami: vista house at Cape Inaho (left); and fish market in Aonae (right) (photo courtesy of N. Shuto).

2.2.2 Observations from the 2004 Indian Ocean Tsunami

Damage observed as a result of the 2004 Indian Ocean tsunami confirmed observations from historic data on tsunami effects, and provided new evidence on observed effects. Figure 2-14 shows a damaged unreinforced masonry house in Devanaanpattinam, India. Foundations experienced severe scour, and the rear walls were forced out by hydraulic pressure due to flooding inside the house. This type of damage is commonly observed in masonry buildings.

As observed in past tsunamis, numerous engineered buildings survived the 2004 Indian Ocean tsunami. In some instances, there was damage to

structural elements at the lower levels, but seldom to an extent that led to total collapse of the structure. One example of a surviving structure is a mosque located at the water's edge in Uleele, Banda Aceh, shown in Figure 2-15. The inundation depth at the mosque was about 10 meters (just under the roof line), and the surrounding town was destroyed. The mosque suffered significant damage but was still standing.



Figure 2-14 Damaged masonry beach house in Devanaanpattinam, India, 2004 Indian Ocean tsunami.



Figure 2-15 Example of surviving reinforced concrete mosque in Uleele, Banda Aceh, Indonesia, 2004 Indian Ocean tsunami (photo courtesy J. Borerro).

Dalrymple and Kriebel (2005) commented that the survival of many hotel buildings in Thailand was due, in part, to the relatively open nature of the first floor construction, so that “these buildings suffered little structural

damage as the force of the tsunami broke through all of the doors and windows, thus reducing the force of the water on the building itself.”

The 2004 Indian Ocean tsunami provided additional evidence of the effects of waterborne debris impact and scour on structural elements. Examples of waterborne debris included fishing boats and vehicles, as shown in Figure 2-16. Damage to structural elements of non-engineered reinforced concrete buildings was attributed to impact from such debris, as shown in Figure 2-17. Examples are also evident where debris damming resulted in damage to structural members, as shown in Figure 2-18. An example of observed scour below a shallow foundation is shown in Figure 2-19. From a review of available data taken by various survey teams, it appears that the maximum scour depth measured onshore was 3 meters in Khao Lak, Thailand.



Figure 2-16 Examples of waterborne debris from the 2004 Indian Ocean tsunami (photos courtesy of M. Saatcioglu, A. Ghobarah and I. Nistor, CAEE, 2005).



Figure 2-17 Damage to non-engineered concrete columns due to debris impact, 2004 Indian Ocean tsunami (photos courtesy of M. Saatcioglu, A. Ghobarah, and I. Nistor, CAEE, 2005).



Figure 2-18 Damage to corner column due to debris damming, 2004 Indian Ocean tsunami (photo courtesy of M. Saatcioglu, A. Ghobarah and I. Nistor, CAEE, 2005).



Figure 2-19 Scour around shallow spread footing in Khao Lak area, Thailand, 2004 Indian Ocean tsunami (Dalrymple and Kriebel, 2005).

A noteworthy structural failure that occurred in the 2004 Indian Ocean tsunami was uplift of precast concrete panels in buildings and docks, as shown in Figure 2-20. Uplift forces were sufficient to lift the concrete panels and break attachments between the panels and the supporting members. These failures cannot be explained by buoyancy effects alone, which reduce net downward gravity forces by the volume of water displaced. Net uplift forces sufficient to fail these elements have been attributed to additional buoyancy effects due to trapped air and vertical hydrodynamic forces caused by the rising water.



Figure 2-20 Uplift damage to precast concrete floor panels and harbor piers, 2004 Indian Ocean tsunami (photos courtesy of M. Saatcioglu, A. Ghobarah, and I. Nistor, CAEE, 2005).

Also, lack of adequate seismic capacity led to a number of collapses of multistory reinforced concrete buildings in Banda Aceh and other areas near the epicenter of the magnitude 9.3 earthquake that triggered the tsunami as Shown in Figure 2-21, these collapses occurred prior to inundation by tsunami waves, and highlight the importance of providing adequate seismic resistance in addition to tsunami resistance in regions where both hazards exist.

2.2.3 Observations from the 2011 Tohoku Tsunami

In the 2011 Tohoku tsunami, tsunami inundation depth was in the range of 5 meters to more than 30 meters along the Tohoku coast. In this event, complete collapse of residential light-frame construction occurred in nearly 100% of all affected areas extending to the edge of the inundation limit. In commercial and industrial areas, 75-95% of low-rise buildings collapsed, with the higher collapse rate occurring as tsunami inundation depths reached the upper limit of the range. In these inundated coastal zones, buildings taller than 5 stories were uncommon.



(a) Beam-column connection failures



(b) Soft story failure

Figure 2-21 Examples of structural collapse due to strong ground shaking in Banda Aceh, Indonesia prior to inundation from the 2004 Indian Ocean tsunami (photos courtesy of M. Saatcioglu, A. Ghobarah, and I. Nistor, CAEE, 2005).

Figure 2-22 shows the extent of devastation in the tsunami inundation zone. Despite this devastation, there were a number of multi-story buildings that survived the tsunami without loss of structural integrity of the vertical load carrying system or foundation. In fact, a significant proportion of the surviving buildings did not appear to have significant structural damage.



Figure 2-22 Scene of near-total devastation in Minamisanriku, Japan, 2011 Tohoku tsunami (photo courtesy of I. Nistor and ASCE, from Chock, et al., 2013b).

The town of Ishinomaki was inundated within 30 minutes of the earthquake that caused the tsunami. There were only three designated vertical evacuation buildings in Ishinomaki, but more than 260 buildings were used for vertical evacuation by those who did not, or could not, evacuate horizontally to high ground (Fraser, et al., 2012). In total, over 50,000 people were saved by using buildings that provided sufficient height and structural resilience to survive the tsunami. This provides some encouragement regarding the potential resistance of larger modern buildings with robust seismic designs and scour- and uplift-resistant foundations, even when not specifically designed for tsunami inundation.

Under a Japanese Cabinet Office guideline (Fukuyama and Okoshi, 2005), buildings to be designated as a tsunami refuge should be made of concrete or other similarly robust materials. They should be at least three stories high in areas where flood levels are predicted to reach two meters, and at least four stories high if flood levels are predicted to reach three meters. The 18 municipal governments in Aomori, Iwate, Miyagi, and Chiba prefectures had designated a total of 88 buildings as vertical evacuation sites.

Figures 2-23 and 2-24 show the designated evacuation area on the roof of a coastal building in Minamisanriku, Japan. This building was built as a residential structure, but with specific vertical evacuation attributes as part of the design. Access to the roof level evacuation area was provided by an external elevator and staircase accessible without entering the rest of the building. The evacuation area measured a total of 660 square meters and was surrounded by a well-braced 2-meter high guard fence. Even though this building was overtopped by 0.7 meters, the 44 people who sought refuge on the roof survived the tsunami.

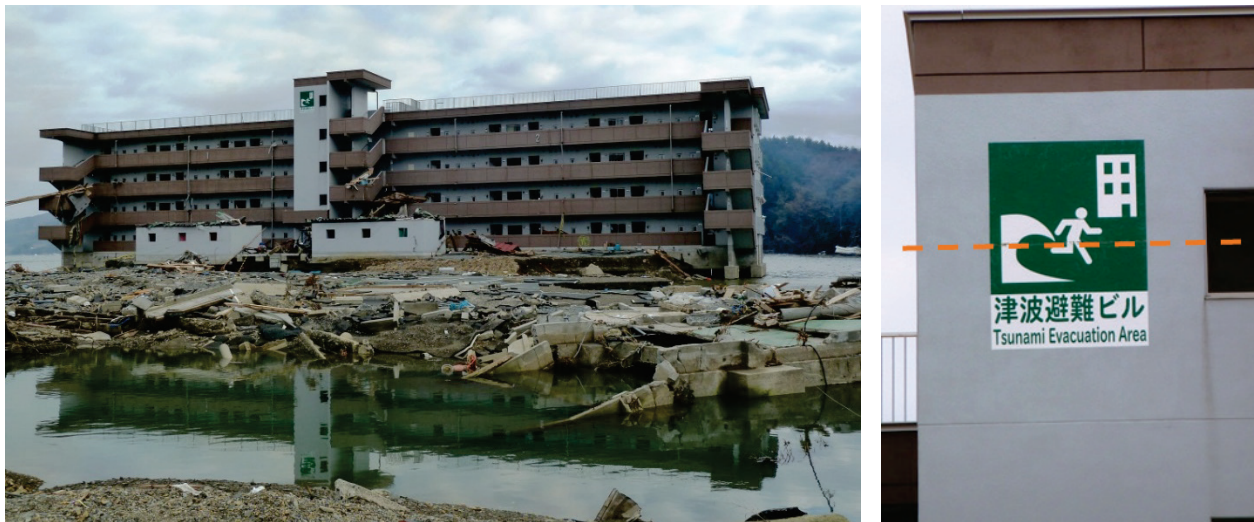

Figure 2-23 Designated tsunami evacuation building in Minamisanriku, Japan, and trace of tsunami inundation level on evacuation signage, 2011 Tohoku tsunami (photos courtesy of I. Robertson and ASCE, from Chock, et al., 2013b)



Figure 2-24 Exterior elevator and stairway access to large roof evacuation area protected by 2-meter high braced guard fence on tsunami evacuation building in Minamisanriku, Japan (photos courtesy of I. Robertson and ASCE, from Chock, et al., 2013b).

Unfortunately, many of the designated vertical evacuation buildings were not tall enough for the inundation depths encountered during the tsunami. An unknown number of people who sought refuge in these buildings did not survive the inundation, even though the structures remained intact. It is paramount that structures designated for vertical evacuation refuge be tall enough to keep evacuees safe during tsunami events that might exceed the design tsunami event.

Figure 2-25 shows a man-made earthen mound (soil berm) located in a park area at the west end of the Port of Sendai, Japan, that was inundated to about half of its height, allowing considerable area for refuge in an otherwise flat region. Similar mounds near the coastline in Natori were overtopped during the tsunami so would not have been suitable as areas of refuge. Only limited erosion was observed on the flanks of these earth mounds, indicating that this concept can work, provided the evacuation site on the top of the mound is well above the inundation depth.

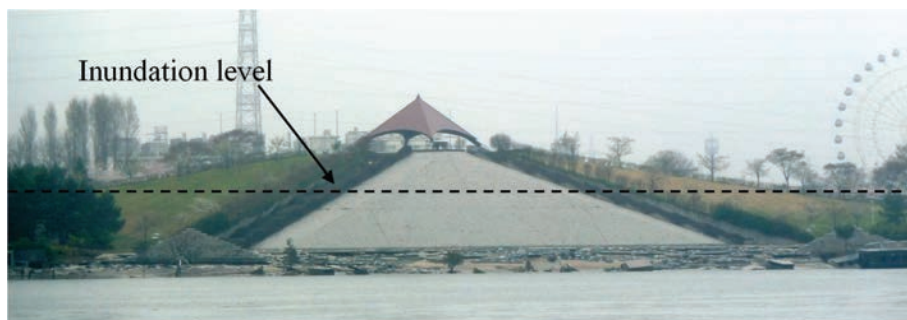

Figure 2-25 Earthen mound at the west end of the Port of Sendai, Japan, 2011 Tohoku tsunami (photo courtesy of I. Robertson and ASCE, from Chock, et al., 2013b).

As observed in prior tsunamis, the 2011 Tohoku tsunami exhibited all types of tsunami loads and effects including hydrostatic forces, hydrodynamic forces, debris damming and debris impact forces, and scour effects. Each of these effects, alone or in combination, was observed to cause structural failures in low- and mid-rise building components of all structural materials. Building performance was not guaranteed by the choice of structural material and structural system alone. Sufficient strength and resistance to impact were critical for avoiding local damage, and resistance to progressive collapse was effective at preventing local component failures from precipitating into disproportionate structural collapse.

A number of low-rise reinforced concrete buildings in Minamisanriku, Japan survived complete inundation, as shown in Figure 2-26. Many of these buildings had solid concrete walls facing the ocean, exposing them to the maximum possible hydrodynamic loading. A nearby reinforced concrete

building, shown in Figure 2-27, with shear walls framing the lower two stories, and concrete cantilever columns supporting a steel truss roof, suffered complete collapse of the top story. The large quantity of trees as debris in the flow, and the susceptibility of cantilever columns to flexural failure, likely contributed to this collapse.



Figure 2-26 Surviving and damaged reinforced concrete buildings in Minamisanriku, Japan, 2011 Tohoku tsunami (photo courtesy of I. Robertson and ASCE, from Chock, et al., 2013b).



Figure 2-27 Collapsed upper story of reinforced concrete building with steel truss roof, 2011 Tohoku tsunami (photo courtesy of I. Nistor and ASCE, from Chock, et al., 2013b).

The harbor town of Onagawa experienced a tsunami surge of more than 18 meters that overtopped nearly all of the buildings in the area, except for those on a central hillside. Outflow velocities following the initial tsunami run-up were particularly high. Despite this, many low-rise steel and concrete buildings survived. Among the failed structures were more than a half-dozen overturned and displaced whole buildings, that were nearly structurally intact from foundation to roof. These buildings were either floated by hydrostatic buoyancy forces and transported away, overturned by hydrodynamic forces due to tsunami inflow or outflow, or a combination of both effects. The relative contributions between these two effects depends on the degree of openness in the building structure, and whether or not the foundation system is adequately anchored.

One such example is shown in Figure 2-28, which was a two-story reinforced concrete cold storage building, with refrigerated storage on the ground floor and refrigeration equipment on the second floor. Because of its intended function, the building consisted of a closed concrete shell, except for doors and a few second story windows for occupants and ventilation. Hydrostatic buoyancy lifted the building off its pile foundation, which did not have tensile capacity, and transported it over a low wall before depositing it about 15 meters inland from its original location.



Figure 2-28 Overturned cold storage building in Onagawa, Japan, 2011 Tohoku tsunami (photo courtesy of G. Chock and ASCE, from Chock, et al., 2013b).

Other concrete and steel buildings were sufficiently open to relieve hydrostatic uplift, but were still overturned by the hydrodynamic forces of the incoming or outgoing flow. A four-story steel frame office building, shown in Figure 2-29, had numerous window openings and lost many of its precast concrete cladding panels. Even without much potential for buoyancy, the hydrodynamic forces were strong enough to fail the connections at the precast concrete piles (or extract the piles from the ground), and the office building was overturned and displaced by about 15 meters.



Figure 2-29 Overturned steel-frame office building in Onagawa, Japan, 2011 Tohoku tsunami (photo courtesy of G. Chock and ASCE, from Chock, et al., 2013b).

Figure 2-30 shows a three-story reinforced concrete commercial building with shear walls on a 0.9-meter thick mat foundation, which overturned toward Onagawa Bay during the tsunami return flow.



Figure 2-30 Overturned three-story commercial building on a mat foundation in Onagawa, Japan, 2011 Tohoku tsunami (photo courtesy of I. Robertson and ASCE, from Chock, et al., 2013b).

2.2.4 Observations from 2005 Hurricane Katrina

During Hurricane Katrina in 2005, the maximum storm surge along the Mississippi Gulf coast was estimated to have been between 7.5 and 8.5 meters (25 and 28 feet) (FEMA, 2006a). This resulted in extensive inundation of low-lying coastal regions from New Orleans, Louisiana to Mobile, Alabama.

Although hurricane storm surge and tsunami inundation both result in coastal flooding, the characteristic behavior of this flooding can be quite different. Hurricane storm surge typically inundates coastal areas for a longer duration with repeated pounding from wave action and gusting winds over a period of several hours.

Tsunami inundation generally takes place over a shorter time period (tens of minutes) with rapidly changing water levels and sweeping currents repeated over a period of hours. Because of these differences, extrapolation of conclusions from hurricane storm surge effects to tsunami inundation effects is necessarily limited. In spite of these differences, however, observations from hurricanes appear to support many of the effects documented with tsunami inundation and conclusions drawn from historic tsunami data.

Observations from hurricanes appear to support many of the effects documented with tsunami inundation and conclusions drawn from historic tsunami data.

The worst storm surge in Hurricane Katrina was experienced between Pass Christian and Biloxi along the Mississippi coast, and thousands of light-framed single- and multi-family residences were totally destroyed or badly damaged by this surge (FEMA, 2006b). However, consistent with observations from past tsunamis, most multi-story engineered buildings along the coastline survived the surge with damage limited to nonstructural elements in the lower levels, as shown in Figure 2-31.

Also consistent with past tsunami observations, Hurricane Katrina illustrated the effects of debris impact and damming. At the parking garage structure shown in Figure 2-32, impact from a barge-mounted casino failed a lower level column resulting in progressive collapse of the surrounding portions of the structure. In Figure 2-33, damming effects were significant enough to fail a series of prestressed concrete piles at a construction site when a shipping container lodged between the piles and blocked the surge flow.

Similar to uplift failures observed in the 2004 Indian Ocean tsunami, uplift loading applied to the underside of floor systems is blamed for the collapse of elevated floor levels in numerous engineered structures. Parking garages constructed of precast prestressed concrete double-tee sections, like the one shown in Figure 2-34, were susceptible to upward loading caused by additional buoyancy forces from air trapped below the double-tee sections



Figure 2-31 Office building in Pass Christian, Mississippi, with a cast-in-place concrete pan joist floor system that suffered nonstructural damage in the first two stories, but no structural damage, 2005 Hurricane Katrina (photos courtesy of I. Robertson).

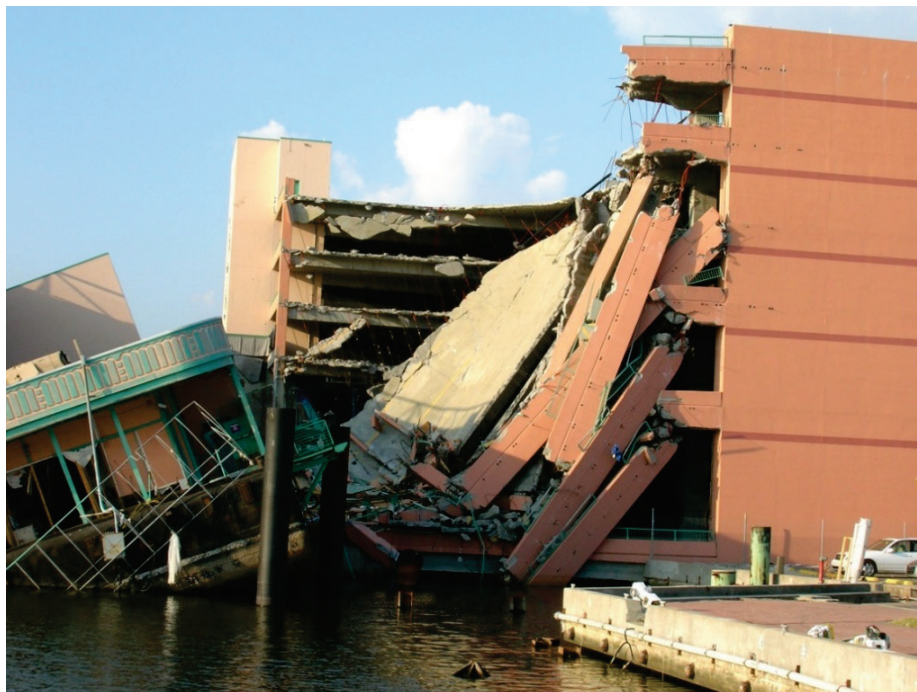

Figure 2-32 Progressive collapse of upper floors of a parking garage due to damage in lower level columns from impact of an adjacent barge-mounted casino, 2005 Hurricane Katrina (photo courtesy of I. Robertson).



Figure 2-33 Failure of prestressed piles due to damming effect of shipping container, 2005 Hurricane Katrina (photo courtesy of I. Robertson).



Figure 2-34 Negative bending failure of a prestressed double-tee floor system due to uplift forces, 2005 Hurricane Katrina (photos courtesy of I. Robertson).

and upward hydrodynamic forces applied by the surge and wave action. Although most failures of this type did not result in collapse of the entire structure, loss of floor framing can lead to column damage, increased unbraced lengths, and progressive collapse of a disproportionate section of the building.

2.2.5 Observations from 2012 Hurricane Sandy

Hurricane Sandy was the second costliest hurricane in U.S. history, surpassed only by Hurricane Katrina. After developing in the Caribbean Sea and moving up the U.S. Atlantic coast as a hurricane, Sandy moved onshore on October 29, 2012, just northeast of Atlantic City, New Jersey, as a post-tropical cyclone with hurricane-force winds. Although Hurricane Sandy affected 24 States, including the entire Atlantic Coast from Florida to Maine, particularly severe damage was caused by storm surge in New Jersey and New York.

Extensive flooding in New York City resulted in flooded streets, tunnels, and subway lines, and loss of power in and around the city. Loss of power forced the evacuation of five New York City hospitals. Following Hurricane Sandy, the Department of Health and Human Services (DHHS) conducted a survey of 174 hospitals in Connecticut, New York, and New Jersey. They found that 69 (or 40%) of these hospitals reported electrical power outages, and that backup generators did not function reliably in 28 (or 41%) of those that lost power (DHHS, 2014). A compounding problem was that fuel for generators was often stored in the basement (per fire regulations) and replacement fuel was difficult to obtain because area gas stations could not pump gas. Lessons learned from these outages, and best practices for maintaining emergency power in critical facilities are provided in FEMA P-1019, *Emergency Power Systems for Critical Facilities: A Best Practices Approach to Improving Reliability* (FEMA, 2014a).

Hurricane Sandy also caused widespread disruption to telecommunication services, including up to 50% of cell towers in the hardest hit counties (NIST, 2016). Flooding of road, rail, and subway tunnels in New York City during Hurricane Sandy caused tremendous disruption to all forms of land-based transportation. It took several weeks before all tunnels could be pumped dry and returned to service. In addition, closure of all three major airports in the New York City metropolitan area resulted in ripple effects of delayed and cancelled flights throughout the country (City of New York, 2013).

2.3 Implications for Tsunami-Resistant Design

Historic tsunami activity and observations from past events show that building survivability varies with construction type and inundation depth. Although certain types of construction are largely destroyed by high-velocity water flow, there is much evidence that appropriately designed structural systems can survive tsunami inundation with little more than nonstructural damage in the lower levels. This enables consideration of vertical evacuation as a viable alternative when horizontal evacuation out of the inundation zone is not feasible, or not practically achievable, for the affected population.

There is much evidence that appropriately designed structural systems can survive tsunami inundation.

This enables consideration of vertical evacuation as a viable alternative when horizontal evacuation out of the inundation zone is not feasible.

Observed effects from historic tsunami data, the 2004 Indian Ocean tsunami, the 2011 Tohoku Japan tsunami, and supporting evidence from extreme storm surge flooding associated with Hurricanes Katrina and Sandy result in the following implications for tsunami-resistant design:

- Vertical evacuation structures must be tall enough to ensure safety of those seeking refuge even if the tsunami exceeds the design tsunami event. They should be well-engineered reinforced concrete or steel-frame structures.
- In the case of near-source-generated tsunami hazards, vertical evacuation structures must be designed for seismic load effects in addition to tsunami load effects, and must consider access issues including post-earthquake functionality of vertical circulation systems (e.g., elevators, escalators, and stairs), and availability of emergency power.
- Vertical evacuation structures should be located away from the wave breaking zone.
- Impact forces and damming effects from waterborne debris are significant and must be considered.
- When elevated floor levels are subject to inundation, uplift forces from added buoyancy due to trapped air and vertical hydrodynamic forces on the floor slab must be considered.
- Scour around the foundations must be considered.
- Emergency power facilities must be provided with adequate fuel supply, located above the anticipated flood level, or adequately protected from water damage.
- Because of uncertainty in the nature of water-borne debris and the potential for very large forces due to impact, progressive collapse concepts should be considered in the design of vertical evacuation structures to minimize the possibility of disproportionate collapse of the structural system.

This chapter provides guidance on planning for tsunami response and considering the use of vertical evacuation solutions. It outlines a process for decision-making, building support, determining the severity of the tsunami hazard, analyzing the need for vertical evacuation, as well as details associated with planning, permitting, and funding vertical evacuation refuge structures.

3.1 Tsunami Awareness and Preparation

Many coastal states and island territories have tsunami preparedness programs funded by the National Oceanic and Atmospheric Administration (NOAA). These programs work with local emergency managers and coastal communities to map inundation areas, develop evacuation plans, routes, and assembly areas, conduct workshops to assist in the development of plans, facilitate exercises to test planning assumptions, and help develop public education programs and materials to support community planning. States may also provide funding for local planning efforts and coordinate planning on a regional basis. U.S. coastal states and island territories that are members of the National Tsunami Hazard Mitigation Program (NTHMP) receive funding annually to help support tsunami evacuation and mitigation policy and programs.

Most preparedness efforts to date have focused on developing effective warning systems, creating and improving inundation and evacuation maps, placing signs for tsunami evacuation routes and assembly areas, and developing educational programs to make evacuation more effective when it becomes necessary. Signs and other materials can be posted in English or other languages, depending on the needs of the local population, including tourists. Examples of tsunami evacuation signage are shown in Figure 3-1.

3.1.1 *TsunamiReady* Program

One example of tsunami preparation includes the *TsunamiReady* Program, overseen by the National Weather Service in coordination with the National Tsunami Hazard Mitigation Program. Under the *TsunamiReady* Program, communities can receive a *TsunamiReady* designation by meeting a series of preparedness, mitigation, and response requirements. Figure 3-2 shows the entrance to Rockaway Beach, Oregon, which has met the conditions to become a *TsunamiReady* city.



Figure 3-1 Examples of tsunami evacuation signage used to identify evacuation routes in Alaska, California, Hawaii, Oregon, and Washington (left), and used to identify a designated assembly area in Puerto Rico (right) (photo courtesy of J.L. Clark; graphic courtesy of Puerto Rico Seismic Network, University of Puerto Rico at Mayaguez).



Figure 3-2 Signage indicating that Rockaway Beach, Oregon is designated as TsunamiReady following the completion of steps to reduce tsunami risk (photo courtesy of J.L. Clark).

The TsunamiReady Program is designed to help cities, towns, counties, universities, and other large sites in coastal areas reduce the risk of disastrous tsunami-related consequences. The goal of the program is to save lives through better planning, education, and awareness. In addition, local and state emergency management agencies can provide guidance on both planning and acquisition of resources to aid in planning efforts. More information about the program is available online at <http://www.tsunami-ready.noaa.gov>.

3.2 Decision-Making Process

Tsunami planning can fit into the emergency management and planning activities that may already be in place in a community for addressing other hazards, such as earthquake, wind, and flood events.

The process of considering a vertical evacuation solution can be initiated by a concerned individual or by a grass-roots advocacy group asking the local government to consider building a vertical evacuation refuge. It could begin with a state or local government body wanting to protect its population, or the need for vertical evacuation could be identified through local government hazard mitigation planning processes.

A successful process will involve a variety of stakeholders, including public, private, and not-for-profit representatives. Relevant stakeholder groups could include neighborhood organizations, land-use planners, emergency managers, engineers, geologists, continuity planners, Chambers of Commerce, other business interests, other government agencies such as the state emergency management agency, or individuals or groups interested in the long-term health of the community.

One advantage of a wide variety of stakeholders is their ability to efficiently disseminate information about tsunami risk and the potential value of vertical evacuation refuge structures. Another advantage is that a broad-based group can help advocate for funding, and may include those with the ability to help fund the project. Public-private partnerships are one model that can be pursued. This is especially important in planning for tsunami response, which is a long-term process addressing a hazard that will continue to threaten future generations.

A flowchart outlining the decision-making process for vertical evacuation refuge planning is shown in Figure 3-3. The steps in the process are described below and additional information is provided in the sections (and chapters) that follow.

Quantify Tsunami Hazard. Given a known or perceived tsunami threat in a region, the first step is to quantify the severity of the tsunami hazard. Tsunami hazard is determined by the presence of a geophysical tsunami source, exposure to tsunamis generated by that source, and the extent of inundation that can be expected as a result of a tsunami reaching the site. Information on tsunami hazard characterization, and consideration of other potentially concurrent hazards, is provided in Section 3.4. Detailed information on quantification of tsunami hazard, including site-specific modeling and inundation mapping, is described in Chapter 7.

Tsunami planning can fit into the emergency management and planning activities that may already be in place in a community for addressing other hazards, such as earthquake, wind, and flood events.

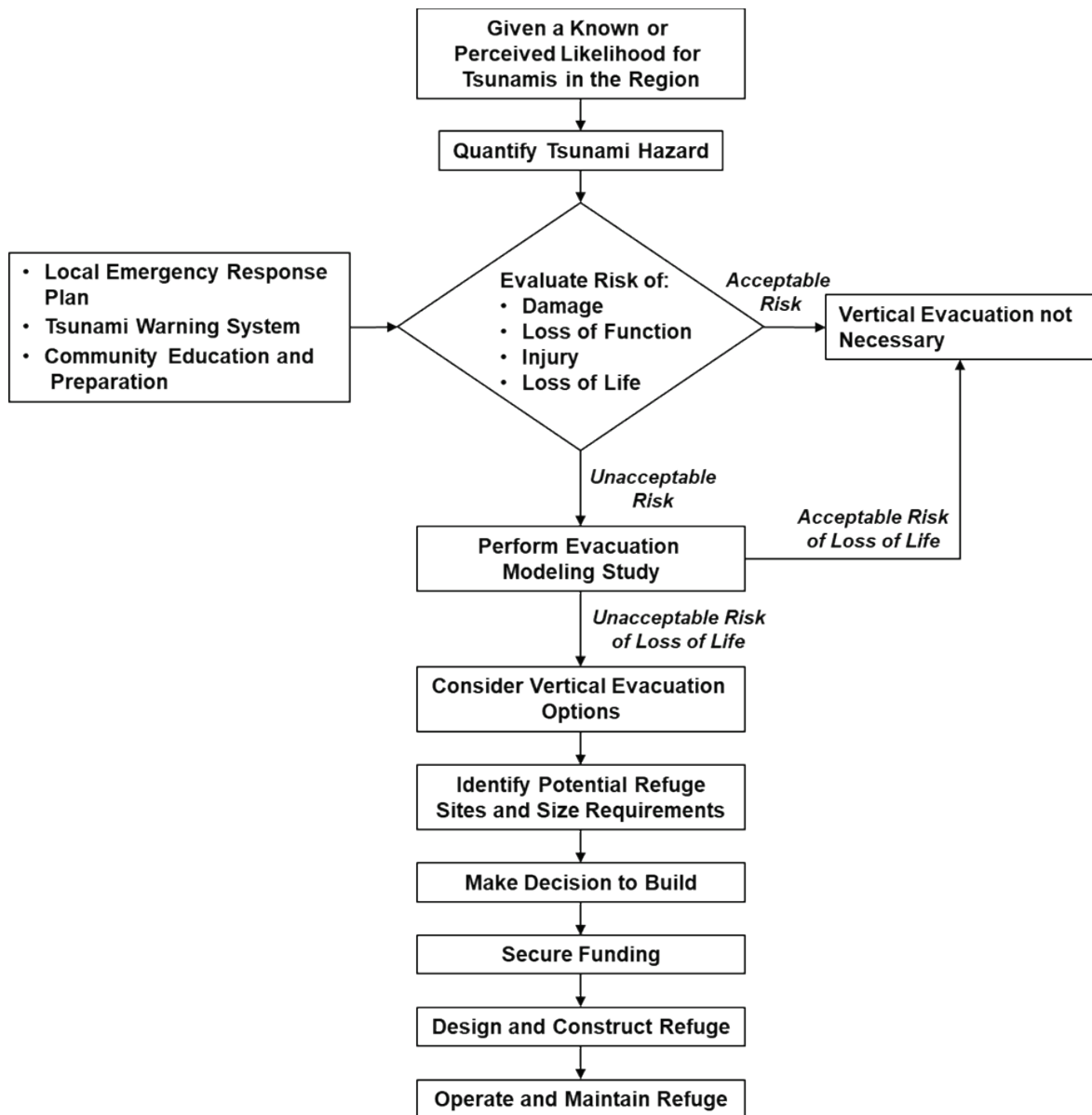

Figure 3-3 Flowchart of decision-making process for vertical evacuation refuge planning.

Evaluate Risk. Given the tsunami hazard and extent of inundation, the potential risk of damage, injury, and loss of life in the region must then be evaluated. Risk will depend on a number of different factors including the presence of a tsunami warning system, existence of a local emergency response plan, availability of various evacuation alternatives, vulnerability of the existing building stock, and locations of existing short- and long-term shelter facilities. The feasibility of evacuation to existing areas of refuge, as well as the tsunami-resistance of those areas, must also be considered. Explicit evaluation of tsunami risk is beyond the scope of this document, but additional information on tsunami vulnerability and risk assessment is provided in Section 3.5.

A difficult decision must then be made as to whether or not the anticipated number of injuries and potential loss of life are acceptable, or if construction of one or more vertical evacuation refuges should be considered. Acceptable risk is difficult to quantify, and the public should be involved in deciding acceptable and unacceptable levels of risk.

Acceptable risk is difficult to quantify, and the public should be involved in deciding acceptable and unacceptable levels of risk.

Perform Evacuation Modeling Study. Evacuation modeling can provide an estimate of likely casualties in a tsunami scenario event, and can guide the development of evacuation plans, vertical evacuation solutions, and associated public education programs. Evacuation modeling can also be repeated with the vertical evacuation refuges in place to determine the estimated reduction in injuries and lives lost during the scenario event. More information on evacuation modeling is provided in Section 3.6.

Evacuation modeling can provide an estimate of likely casualties in a tsunami scenario event. Modeling can also be repeated with vertical evacuation refuges in place to determine the estimated reduction in injuries and lives lost during the same event.

Consider Vertical Evacuation Options. Based on the assessed vulnerability and potential resources in a region, a decision can be made as to whether or not vertical evacuation is needed, what capacity for evacuation is needed, where it should be sited, and what type of structure should be built or designated as a refuge. Vertical evacuation refuges will be most useful when there is not enough time between the tsunami warning and tsunami inundation to allow a community to evacuate out of the inundation zone or to existing areas of high ground. Additional guidance on considering the need for vertical evacuation is provided in Section 3.7. Various options and additional considerations for vertical evacuation solutions are presented in Chapter 4.

Vertical evacuation refuges will be most useful when there is not enough time between the tsunami warning and tsunami inundation to allow a community to evacuate out of the inundation zone or to existing areas of high ground.

Identify Refuge Site and Size Requirements. Implementation of vertical evacuation requires a distribution of structures throughout the community that are appropriately sized for the population. Guidance on siting, spacing, sizing, and elevation considerations for the distribution of vertical evacuation refuge structures throughout a community are provided in Chapter 5.

Implementation of vertical evacuation requires a distribution of structures throughout the community that are appropriately sized for the population.

Make Decision to Build. Design and construction of a network of designated vertical evacuation structures, securing funding, performing maintenance, operating, and periodically re-evaluating these structures will require long-term commitments by all stakeholders. Involving a cross-section of interests across a variety of stakeholder groups will generate more support for the project, allow access to a greater number of funding possibilities, and increase the chances of a successful program for vertical evacuation.

Secure Funding. State and local governments can obtain funding for vertical evacuation structures through grants from different departments and agencies of the federal government, public-private partnerships, or state and local revenue sources. It is expected that structural construction costs will be

higher for vertical evacuation structures than for normal-use structures. Cost considerations are outlined in Section 3.8. Potential sources of funding to cover the costs associated with planning and implementing vertical evacuation solutions are described in more detail in Section 3.9.

Design and Construct Refuge. Tsunamis are extreme events, and design of vertical evacuation structures for tsunami load effects will require more strength and robustness than is necessary for normal-use structures. Consensus design criteria for tsunami vertical evacuation refuge structures are now contained in ASCE/SEI 7-16, *Minimum Design Loads and Associated Criteria for Buildings and Other Structures* (ASCE, 2016). Additional guidance and commentary on the development of tsunami load equations are provided in Chapter 8.

Unique structures designed for extreme hazards require special consideration in planning, permitting, construction, and quality assurance.

Unique structures designed for extreme hazards require special consideration in planning, permitting, construction, and quality assurance. Special planning considerations are outlined in Section 3.10, and guidance on permitting and quality assurance requirements are provided in Section 3.11.

Operate and Maintain Refuge. Operational considerations include pre-tsunami public awareness, issuance of tsunami warnings, drills and dissemination of evacuation instructions, criteria for opening and closing the facility, and a plan for maintaining the supplies and the facility. Operational and maintenance considerations for vertical evacuation refuge structures are described in Chapter 6.

3.3 Making Tough Choices

Developing and implementing a vertical evacuation strategy involves serious decisions that often have no clear-cut answer. An acceptable level of risk is a complex notion, and an acceptable number of casualties is difficult to quantify. Resources are often limited, and a community might not be able to achieve the ideal solution in terms of the number and location of vertical evacuation structures necessary to protect the entire population. In practice, a community may only be able to afford one vertical evacuation structure.

If there is insufficient funding to provide an adequate number of vertical evacuation structures to protect the entire population at risk, questions about where the structures should be built, or whether structures should be located in less than ideal places, will need to be addressed. Some communities may question the use of existing buildings in an evacuation plan when such buildings have not been constructed to specific tsunami design criteria, even when there are no better options.

The specific conditions and resources available in each community will drive the answers to these and other difficult questions that will inevitably arise in the planning process. The tradeoffs are not easy, and will require discussion among the various stakeholder groups within the affected community.

3.3.1 Long-Term View

Even if the community cannot afford to implement a vertical evacuation solution in the near-term, it is important to make identification and construction of vertical evacuation structures a priority, and to move forward with a long-term plan. The process can be started by researching building options and possible sites, considering interim alternative refuge facilities, and preparing the public through community education efforts. As resources become available, intermediate steps can be taken. In the event of a damaging tsunami, anything done to decrease the eventual number of casualties is a good use of resources.

3.3.2 Potential Liability

Implementing a vertical evacuation solution is a long-term effort. Vertical evacuation structures must be planned, built, maintained, and be ready for immediate use in the event of a tsunami. Questions of liability may arise at each step of the way, and answering them is an important part of the planning process. In general, communities making a good faith effort to address a hazard should not be held not liable for damages. Each community should, however, seek legal counsel for its specific situation.

3.4 Quantifying Tsunami Hazard

Tsunami hazard assessment is a complex process influenced by many parameters. An essential component of quantifying the tsunami hazard is modeling of tsunami inundation. Fortunately, nationally coordinated efforts including the National Oceanic and Atmospheric Administration (NOAA) Tsunami Program and the National Tsunami Hazard Mitigation Program (NTHMP) have been working to quantify tsunami hazard. Results from tsunami hazard assessments are essential components in emergency management planning and have been used to guide the development of evacuation maps, public education and training materials, and tsunami risk reduction plans.

For purposes of design, tsunami hazard can be taken from Tsunami Design Zone (TDZ) maps provided in the ASCE Tsunami Design Geodatabase (ASCE, 2017), or can be determined through site-specific probabilistic tsunami hazard analysis (PTHA). Detailed characterization of tsunami

hazard, including site-specific modeling and inundation mapping, is described in Chapter 7.

3.4.1 *Considering Concurrent Hazards*

Tsunami events can be preceded or followed by other natural hazards, including earthquakes, landslides, and floods.

When considering vertical evacuation options, it is important to keep in mind that tsunami events can be preceded or followed by other natural hazards. The consequences of concurrent hazard events should be considered in the decision-making and planning processes:

- **Earthquakes.** Most tsunamis are generated by earthquakes. In a near-source-generated event, the triggering earthquake may be larger than magnitude 7, and can cause significant damage before the first tsunami wave hits. A tsunami vertical evacuation refuge structure must first be able to withstand this earthquake and remain functional. Nonstructural building systems must be sufficiently functional to allow occupancy and rapid vertical access to the upper levels. A large earthquake can disorient the population, destroy roads and bridges, and create debris that can make tsunami waves more destructive. A strong communication program will be needed to educate the public that, contrary to natural instinct, a tsunami vertical evacuation refuge can be safe to enter following a major earthquake, and that it can withstand tsunami forces as well as aftershocks that may occur while they are in the refuge.
- **Landslides.** An earthquake that generates a near-source-generated tsunami can also trigger landslides onshore. Additionally, tsunami waves themselves can scour hillsides, producing more landslides. The potential for landslide hazards should be considered when planning evacuation routes and assembly areas, including vertical evacuation refuges.
- **Floods.** Tsunami waves can travel upstream and cause flooding along rivers and waterways. Although tsunamis rapidly lose energy and elevation as they proceed up coastal rivers and estuaries, low-lying areas near the coast may be vulnerable to tsunamis. Low-lying areas may also be subject to riverine, tide, and storm surge flooding, and may be slow to drain after a tsunami, making it more difficult for rescue personnel to reach those who have sought refuge in buildings located in flood zones. The location of vertical evacuation refuge structures should consider the potential for residual flooding, access for rescue personnel, and eventual egress of occupants from the refuge after the tsunami “all clear” signal has been given.

3.5 Vulnerability and Risk Assessment

A vulnerability and risk assessment estimates the percentage of the population exposed to tsunami inundation that is at risk for potential injury or loss of life. It considers the size of the vulnerable population, where people are located, how far they can travel, and what options are available for evacuation or refuge. Vulnerable populations include those with limited mobility, often seniors or young children, and those in low-lying areas where high ground is not easily accessible. Populations can vary considerably, from day to night, or season to season, depending on the residential population and number of visitors or seasonal tourists in a community.

Increasing the preparedness of a population can reduce tsunami risk. People are less vulnerable if they know what to expect and how to react. Activities such as an ongoing public education program including evacuation drills, and the development of inundation maps, evacuation routes, assembly areas, and local tsunami warning dissemination protocols can make the community less vulnerable.

The quality of the building stock is a critical parameter in vulnerability and risk assessment. Compared to older buildings, newer buildings that meet modern seismic codes are better able to withstand the intense ground shaking that precedes a near-source-generated tsunami, and will have a lower risk of collapsing and trapping people trying to evacuate the inundation zone. Buildings still standing after an earthquake, however, may not be able to withstand the forces of a subsequent tsunami.

Currently available regional loss estimation software could be useful for tsunami vulnerability and risk assessment. One such tool is Hazus-MH, which is FEMA's Hazards U.S. Multi-Hazard software (FEMA, 2014b). A tsunami module has recently been added to Hazus-MH, to go along with its long-standing earthquake module, which has been used to determine regional earthquake damage and losses. Hazus-MH includes a standardized methodology for estimating damage and losses, which includes quantitative default information that can be used in a vulnerability assessment, including population, building types, numbers of buildings, and locations of important facilities. However, default representations of building construction and default population distributions may not be sufficiently accurate for the conditions in a specific community, and the building and infrastructure vulnerability models for tsunami hazards in Hazus-MH are still rudimentary. Significant effort will likely be required to create a Hazus-MH tsunami vulnerability model that is appropriate for a local community.

FEMA's Hazards U.S. Multi-Hazard (Hazus-MH) could be a useful tool for tsunami and earthquake vulnerability and risk assessments.

3.6 Use of Evacuation Modeling

Various evacuation modeling approaches have been developed to simulate evacuation by foot or in vehicles prior to tsunami inundation. Least-cost-distance (LCD) models can adjust for initial response time, travel speed, terrain slope, road networks, as well as ad-hoc off-road evacuation routes (Wood, et al., 2016). Effects of increased evacuation path length due to landslide debris, seismic damage to roads, bridges and collapsed buildings can also be accommodated by such models.

Agent-based modeling and simulation (ABMS) has been adapted from transportation modeling applications to perform multimodal tsunami evacuation simulations (Wang, et al., 2015; Mas, et al., 2012). These models attempt to simulate the actions of every individual assumed to be in the inundation zone at the time of the tsunami warning as they make evacuation decisions. Numerous assumptions must be made about the time taken to initiate evacuation, route selection, speed of travel, and condition of evacuation routes given the potential for earthquake damage. Increased interest in these models has led to significant improvements in their capabilities.

Considerations of evacuation egress time, population density, population demographics, and the physical endurance to sustain robust evacuation speed over significant distance, egress routes, traffic, time of day, post-earthquake damage to infrastructure, tsunami awareness and preparation, knowledge of surroundings, visitor population, and the available time between tsunami warning and tsunami arrival all factor into determining the likely evacuation clearing time and resulting fatalities (Chock, et al., 2018). Modeling should be performed with combinations of both optimistic and pessimistic estimates of input variables to provide a likely range of results. Modeling should also include potential increases in population resulting from seasonal tourist influx, as well as potential future long-term population growth.

Evacuation modeling can then be repeated with the vertical evacuation refuges in place to determine the estimated reduction in injuries and lives lost during the same events. For example, in a study of tsunami evacuation in Seaside, Oregon, Wang, et al. (2015) demonstrated that three vertical evacuation structures could result in an estimated reduction in mortality rate from 31% to 10%, even when considering a relatively slow assumed travel time of approximately 1 m/sec (2.2 mph). Such an approach can be used to identify ideal locations of refuge, and can help estimate the number of people that must be accommodated at each refuge facility (Park, et al., 2012; Wood, et al., 2014).

3.7 Considering the Need for Vertical Evacuation

Based on the assessed vulnerability and potential resources in a region, the need for vertical evacuation can be considered. If it is determined that vertical evacuation would help mitigate tsunami risk, it is possible that vertical evacuation options are not needed everywhere, and may not be needed by everyone, within a given community.

The following information will help determine the need for vertical evacuation:

- the topography of the area and availability of high ground;
- available warning time and travel time needed for evacuation;
- age and construction of the building stock;
- total number of residents in an area;
- variations in population due to seasonal or other fluctuations;
- presence and size of vulnerable populations;
- preparedness of residents and visiting populations; and
- preparedness of emergency management and response operations.

Much of this information may have already been collected in available land-use and emergency management plans. For example, Figure 3-4 shows a tsunami evacuation map for Bandon, Oregon prepared by the State of Oregon Department of Geology and Mineral Industries (DOGAMI). The map shows evacuation zones, evacuation routes, and assembly areas created as a result of such an analysis. Evacuation areas are colored orange for distant (far-source-generated) tsunamis, and yellow for local (near-source-generated) tsunamis. Evacuation routes are designated by arrows and assembly areas are designated by symbols with the letter “A”.

It should be emphasized that evacuation to high ground is always preferred over vertical evacuation where access to nearby high ground exists. This allows the option for refugees to move to even higher ground if the tsunami inundation is greater than anticipated, something that may not be possible in a vertical evacuation structure or earthen mound.

It may not always be feasible to construct new buildings in an area that requires a vertical evacuation refuge. Use of existing buildings becomes the next possible option, and may become a necessity. Special considerations for the use of existing buildings as tsunami vertical evacuation refuge structures are outlined in Chapter 9.

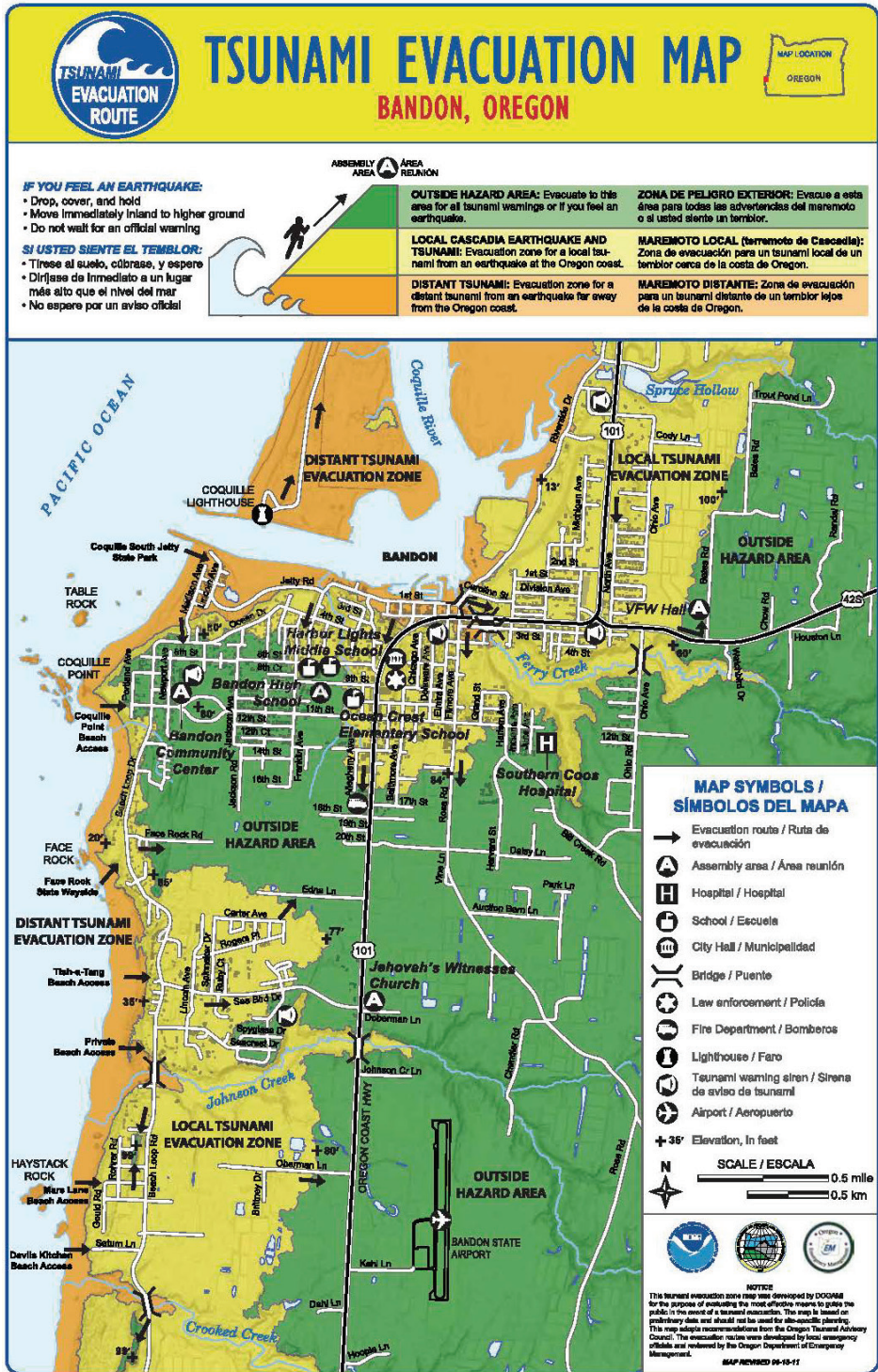

Figure 3-4 Tsunami evacuation map for Bandon, Oregon (DOGAMI, 2018).

3.8 Cost Considerations for Vertical Evacuation Structures

Design of vertical evacuation structures for tsunami load effects will require more strength and ductility than is necessary for normal-use structures. This can include the use of seismic detailing provisions, progressive collapse preventative measures, customized breakaway wall details, and deeper foundation systems that will serve to increase the robustness of the resulting structure. It is expected that structural construction costs will be higher for vertical evacuation structures than for standard occupancy structures.

Although there are no direct comparisons between the cost of a conventional structure versus the cost of a tsunami-resistant structure, order-of-magnitude information on potential structural construction cost increases can be obtained from currently available information (Carden, et al. 2016; Nitta and Robertson, 2014).

Structural costs, however, are only a portion of the total construction costs for a building. Depending on the nature of building occupancy and use, structural construction costs can range between 10% and 40% of total construction costs. Structural costs are a lower percentage of the total for occupancies with special uses requiring more expensive nonstructural systems and contents (e.g., hospitals), and are a higher percentage of the total for occupancies with standard uses (e.g., offices, parking garages).

Structural construction costs are only a fraction of total construction costs for a building.

Anecdotal evidence from design and construction of hospital facilities in California, Oregon, and Washington indicate that the cost premium for seismic design requirements associated with essential facilities versus standard occupancies is on the order of 10% to 20% of structural construction costs. This would represent an increase on the order of 1% to 8% in terms of total construction costs.

In a study funded by the National Institute of Standards and Technology (NIST), *Engineering Design and Cost Data for Reinforced Concrete Buildings for Next Generation Design and Economic Standards for Structural Integrity* (NIST, 2007), the cost premium for progressive collapse-resistant design was on the order of 10% to 20% of structural construction costs. Similar to seismic design, this would represent an increase on the order of 1% to 8% in terms of total construction costs.

It is reasonable to expect that a tsunami-resistant structure would experience about a 10% to 20% order-of-magnitude increase in total construction costs.

It should not be assumed that incorporation of tsunami-resistant design features will be cost prohibitive.

Considering additional allowances for added strength to resist tsunami load effects, it is reasonable to expect that a tsunami-resistant structure, including seismic-resistant and progressive collapse-resistant design features, would experience about a 10% to 20% order-of-magnitude increase in total

construction costs over that required for normal-use buildings. While each project will be unique, and relative costs will depend on the specific tsunami hazard and site conditions, it should not be assumed that incorporation of tsunami-resistant design features in a vertical evacuation structure will be cost prohibitive.

3.9 Potential Sources of Funding

State and local governments can obtain funding for vertical evacuation structures through grants from different departments and agencies of the federal government, public-private partnerships, or state and local revenue sources. The State of Washington Emergency Management Division (EMD) has prepared a listing of federal, private, and non-profit funding, program, and technical assistance resources that may be available pre- and/or post-disaster, available at <https://mil.wa.gov/uploads/pdf/emergency-management/feddisasterrecoveryfundinglinks.pdf> (Washington EMD, 2018).

Local governments also have a variety of mechanisms that can be employed to reduce the financial burden and incentivize private partnership in the construction of vertical evacuation refuge structures. One mechanism is to encourage development of vertical evacuation structures by offering tax incentives. Another mechanism could involve requiring new coastal construction projects to include vertical evacuation facilities in exchange for relaxed height restrictions. Strategies will differ from community to community (Chock, et al., 2018).

Figure 3-5 shows the first vertical evacuation refuge structure built in the United States at Ocosta Elementary School in Westport, Washington. The new cafeteria and gymnasium building was partially funded by a special bond issue approved by a local community referendum. It was constructed in 2016 with a roof level tsunami refuge following the provisions of FEMA P-646 and ASCE/SEI 7-16. While serving as a fully functional school building, this structure now also offers a vertical evacuation refuge for students at the elementary and nearby junior-senior high school and members of the surrounding community who are not able to make it to high ground prior to a near-source tsunami generated by the Cascadia Subduction Zone. Additional information on the design and construction of this refuge structure is provided in Appendix A.



Figure 3-5 Tsunami evacuation refuge over a cafeteria and gymnasium at Ocosta Elementary School, Westport, Washington (photo courtesy of P. Akerlund).

3.9.1 Federal Funds

Possible sources of federal funding include the Federal Emergency Management Agency, the Department of Commerce, Department of Homeland Security, Department of Housing and Urban Development, Department of the Interior, the Small Business Administration, and the Veterans Administration, among others.

FEMA's Pre-Disaster Mitigation (PDM) Grant Program, <https://www.fema.gov/pre-disaster-mitigation-grant-program>, is designed to assist States, U.S. Territories, Federally-recognized tribes, and local communities in implementing a sustained pre-disaster natural hazard mitigation program. Projects submitted for PDM grant funding must be consistent with the goals and objectives identified in the current, FEMA-approved State or Tribal (Standard or Enhanced) hazard mitigation plan. Tsunami risk and vulnerability assessments, including the running of Hazus-MH, are activities eligible for PDM grant funding as part of the scope of work for developing a hazard mitigation plan.

FEMA's Hazard Mitigation Grant Program (HMGP), <https://www.fema.gov/hazard-mitigation-grant-program>, is designed to help communities implement hazard mitigation measures following a Presidential Major Disaster Declaration in the areas of the state, tribe, or territory requested by the Governor or Tribal Executive. The purpose of this grant program is to enact mitigation measures that reduce the risk of loss of life and property from future disasters. HMGP funding is available to support efforts to plan and build a vertical evacuation structure as a pilot project under the Hazard

FEMA funding is available for vertical evacuation structures as a pilot project under the Hazard Mitigation Grant Program.

Mitigation Grant Program (HMGP). A proposed vertical evacuation refuge berm in Oregon was the first to be approved for funding in 2016.

Another example of a grant program is the Community Development Block Grant (CDBG) Program from the Department of Housing and Urban Development, https://www.hud.gov/program_offices/comm_planning/communitydevelopment/programs, which is a flexible program that provides communities with resources to address a wide range of unique community development needs. CDBG funding could be used to help build a vertical evacuation refuge structure if it is co-located with a qualifying asset, such as a community center.

Because vertical evacuation refuge structures are a relatively new concept addressing a hazard not normally covered by these programs, it may take some time for agencies to modify the federal regulations governing their programs to qualify these types of projects. Each community should work with the applicable state and federal offices to explore the options available for its specific needs.

3.9.2 Public-Private Partnership

The community might develop a public-private partnership to build a vertical evacuation structure if there is a new private-sector or tribal development being planned in the community that could support vertical evacuation. For example, if a new hotel is being considered, a city might be able to partner with the developer to build it to a higher standard, allowing the public to use it as a vertical evacuation structure in case of a tsunami. Some zoning requirements, such as height restrictions, could be waived for the hotel as an incentive, and a way to ensure adequate refuge area above the potential inundation elevation.

If such a partnership is forged, there should be a clear understanding in advance that the public will have free access to all entrances in the facility in the event of a tsunami evacuation. Many facilities routinely lock all but one central door, limiting free access. If using a privately funded facility, explicit legal agreements will need to be negotiated. Ownership and liability issues must be agreed to before the building and refuge are constructed.

3.9.3 Self-Funding

It might be difficult to wholly self-fund a vertical evacuation structure, but there are opportunities to generate revenue by co-locating a vertical evacuation facility with a different primary use such as a parking garage, school, or community center. The vertical evacuation structure would be

available for emergencies, but the primary use would provide a community service or could generate money to repay initial bonds or investment. Alternatively, revenue from the primary use could be dedicated and reserved until a sufficient amount is available to modify the structure to include a vertical evacuation component.

3.9.4 State and Local Revenue

State and local governments are funded by a variety of tax and fee mechanisms. Each of these should be investigated to see if they could provide partial or total funding for a vertical evacuation strategy.

State and local governments also have the ability to raise money for dedicated projects. For example, a project like building engineered high ground that could also be used as a park or open space might be paid for by a local improvement district. A special bond assessment could also be used for funding.

Another alternative is to provide tax incentives or waive zoning requirements or height restrictions to add a refuge capability to private development. The state or local government would not have to raise cash to contribute to a project but would reduce tax assessments or provide other relief in exchange for the additional cost of the tsunami refuge.

3.10 Planning for Vertical Evacuation Structures

In addition to structural design considerations, planning for vertical evacuation facilities should consider a number of other issues, including access, parking, pets, occupancy limitations, and protection of critical functions.

- **Access and Entry.** Confusion and panic will occur if evacuees arrive at a refuge and cannot enter. Provisions should be made to ensure access in the event of a tsunami, while providing adequate security during times when the facility is unoccupied. Ideally, a vertical evacuation refuge should be configured so that it is always accessible, or can be entered without emergency personnel.
- **Americans with Disabilities Act (ADA).** Vertical evacuation structures, when not operating as a refuge, must comply with Federal, state, and local ADA requirements and ordinances for the normal daily use of the facility. Design of ingress and vertical circulation within a vertical evacuation structure should consider the needs of disabled occupants to the extent possible, and the extent required by law, in the case of emergency evacuation. Given potential limitations on

Planning for vertical evacuation structures should allow for:

- Access and Entry
- Americans with Disabilities Act
- Parking
- Pets
- Occupancy Limitations
- Protection of Critical Functions

functionality of power sources and vertical conveyance systems (e.g., elevators and escalators) in the event of a near-source earthquake, disabled occupants may need assistance accessing refuge areas in vertical evacuation structures.

- **Parking.** Parking at evacuation facilities can be a problem. Traffic congestion can adversely affect access to the facility, and parked vehicles can become waterborne debris that can damage the structure. Planning for vertical evacuation facilities should consider parking limitations.
- **Pets.** Refuge facilities are typically not prepared to accommodate pets. Many people, however, do not want to leave their pets behind during a disaster. Planning should carefully consider the policy regarding pets.
- **Occupancy Limitations.** Population density can be non-uniform, and can vary by time of day, week, or year. In the event of a tsunami, evacuation behavior of the surrounding population may result in an unequal distribution of evacuees among available refuge facilities. In determining the maximum occupancy for a refuge facility, the time of day, day of the week, or season of the year that will result in the largest number of possible evacuees should be considered. The maximum occupancy might need to be increased in order to accommodate unexpected additional occupants or visitors in the area.
- **Protection of Critical Functions.** A vertical evacuation facility must be able to serve its intended function in the event of a tsunami. Functions that are critical for operation as a short-term refuge, emergency response, medical care, or long-term sheltering facility must be protected from tsunami inundation, or located within the area of refuge. These might include emergency power, electrical equipment, communications equipment, basic sanitation needs, medical and pharmaceutical supplies, and emergency provisions (e.g., food, water, and supplies).

3.10.1 Land Use Planning

Building a vertical evacuation structure within an inundation zone may require special planning and zoning permissions.

Comprehensive planning and zoning ordinances may not include vertical evacuation structures as a permitted use. In some cases, height limitations may need to be waived. A variance or conditional use permit, or change in the underlying zoning for the site, may be required. This step may add to the cost of the structure.

Some communities do not allow new critical facilities, such as fire stations and hospitals, to be built within an inundation zone. Even though a vertical evacuation structure is different than a critical facility, the rules may require special permission to build a vertical evacuation structure within an

inundation zone. Research must be done in each area to determine if these or other restrictions apply.

3.11 Permitting and Quality Assurance for Vertical Evacuation Structures

The unique nature of vertical evacuation structures requires special allowances for permitting and code compliance, peer review, and design and construction quality assurance.

3.11.1 Permitting and Code Compliance

Before construction begins, all necessary state, local, building, and other permits should be obtained. Structural and geotechnical design of the vertical evacuation refuge must be performed in accordance with the requirements in ASCE/SEI 7-16.

In general, mechanical, electrical, and plumbing systems should be designed for the normal daily use of the facility, unless otherwise directed by the authority having jurisdiction. Designing these systems for the high occupancy load that would occur only when the structure is serving as a vertical evacuation refuge may not be necessary.

3.11.2 Peer Review

A vertical evacuation structure is a unique structure that must withstand special loads and load combinations. While earthquake, wind, and flood loading effects are well understood in the design and permitting process, consideration of tsunami load effects includes new concepts and approaches. Considering the importance of vertical evacuation structures and the extreme nature of tsunami loading, independent peer review by an appropriately licensed design professional is required in ASCE/SEI 7-16.

3.11.3 Quality Assurance / Quality Control

Because a vertical evacuation structure must perform well during extreme loading conditions, quality assurance and quality control for the design and construction of the structure should be at a level above that for normal occupancy construction. Design calculations and drawings should be thoroughly scrutinized for accuracy.

The quality of both construction materials and methods should be ensured through the development and application of a quality control program. A quality assurance plan should be based on the special inspection requirements in the *International Building Code* (ICC, 2018). Special inspections and quality assurance provisions for primary seismic- and wind-

The unique nature of vertical evacuation structures requires special allowances for:

- permitting and code compliance;
- peer review; and
- design and construction quality assurance.

resisting systems should be applied to tsunami-resisting elements of vertical evacuation structures. Exceptions that waive the need for quality assurance when elements are prefabricated should not be allowed.

In addition to the building elements that are normally included in special inspection programs, the following items require special attention:

- Tsunami breakaway walls and their connections to structural components to avoid unintended conservatism in construction.
- Other special components or details that are used to minimize tsunami-loading effects.
- Piles, pilecaps and grade beams that will potentially experience the effects of scour.

Options for Vertical Evacuation

This chapter describes considerations associated with vertical evacuation, presents different options for vertical evacuation solutions, and provides guidance for choosing among the various alternatives.

4.1 Vertical Evacuation Considerations

A vertical evacuation refuge is a structure or earthen mound designated as a place of refuge in the event of a tsunami, with sufficient height to elevate evacuees above the tsunami inundation depth, designed and constructed to resist tsunami load effects. A vertical evacuation refuge can be stand-alone or part of a larger facility. It can be intended for general use by the surrounding population, or by the occupants of a specific building or group of buildings. It can be a single-purpose, refuge-only facility, or a multi-purpose facility in regular use when not serving as a refuge. It can also be a single-hazard (tsunami only) facility or a multi-hazard facility.

In concept, vertical evacuation options are applicable to both new structures and existing structures. Existing structures can be evaluated for tsunami design criteria, and, in some cases, demonstrated to be sufficiently robust for resisting tsunami load effects, but it can be more difficult to retrofit an existing structure than to build a new structure using tsunami-resistant design criteria. Special considerations for the use of existing buildings as vertical evacuation refuge structures are outlined in Chapter 9.

In concept, vertical evacuation options are applicable to both new structures and existing structures, but it can be more difficult to retrofit an existing structure than to build a new structure using tsunami-resistant design criteria.

Choosing between various options available for vertical evacuation will depend on emergency response planning and needs of the community, the type of construction and use of the buildings in the immediate vicinity, and the project-specific financial situation of the state, municipality, local community, or private owner considering such a structure.

4.1.1 Single-Purpose Facilities

A tsunami hazard assessment and inundation study may show that the best solution is to build new, separate (i.e., stand-alone) facilities specifically designed and configured to serve as vertical evacuation structures. Potential advantages of single-purpose, stand-alone facilities include the following:

- They can be sited away from potential debris sources or other site hazards.
- They do not need to be integrated into an existing building design or compromised by design considerations for potentially conflicting uses.
- They are structurally separate from other buildings and therefore not subject to the potential vulnerabilities of other building structures.
- They will always be ready for occupants and will not be cluttered with furnishings or storage items associated with other uses.
- Single-purpose, stand-alone structures will likely be simpler to design, permit, and construct because they will not be required to provide normal daily accommodations for people. They can have simplified prototypical structural systems, resulting in lower initial construction costs.

One example of a single-purpose facility is a small, elevated structure with the sole function of providing an elevated refuge for the surrounding area in the event of a tsunami. A possible application for such a facility would include low-lying residential neighborhoods where evacuation routes are not adequate, and taller safer structures do not exist in the area.

4.1.2 Multi-Purpose Facilities

A coastal community may not have sufficient resources to develop a single-purpose tsunami vertical evacuation structure or series of structures, requiring creative ways of overcoming economic constraints. Possible solutions include co-location of evacuation facilities with other community-based functions, co-location with commercial-based functions, and economic or other incentives for private developers to provide tsunami-resistant areas of refuge within their developments. The ability to use a facility for more than one purpose provides more immediate possibility for a return on investment through daily business or commercial use when the structure is not needed as a refuge.

Multi-purpose facilities can also be constructed to serve a specific need or function in a community, in addition to vertical evacuation refuge. Examples include elevated man-made earthen berms used as community open spaces. In downtown areas or business districts, they can be specially constructed private or municipal parking structures incorporating tsunami resistant design. On school campuses, vertical evacuation facilities could serve as gymnasiums or lunchrooms on a daily basis. In residential subdivisions, they can be used as community centers.

4.1.3 Multi-Hazard Considerations

Communities exposed to other hazards (e.g., earthquakes, landslides, floods) may choose to consider the possible sheltering needs associated with these other hazards, in addition to tsunamis. This could include allowances for different occupancy durations, consideration of different post-event rescue and recovery activities, and evaluation of short- and long-term medical care needs.

Designing for multiple hazards requires consideration of load effects that might lead to structural solutions that are unique to each type of hazard. This can pose challenges for the resulting structural design. For example, the structural system for a vertical evacuation structure exposed to near-source-generated tsunamis will likely need to be designed for seismic hazards. Proper design and construction must include special consideration by the structural engineer for potential conflicting needs associated with different hazards.

4.2 Vertical Evacuation Concepts

To provide refuge from tsunami inundation, vertical evacuation solutions must have the ability to receive a large number of people in a short period of time and efficiently transport them to areas of refuge that are located above the level of inundation. Ease of ingress and unimpeded vertical circulation, including features such as exterior stairs and ramps, are important components of vertical evacuation solutions. Areas of naturally occurring high ground, areas of artificial high ground created through the use of soil berms, new structures specifically designed to be tsunami-resistant, or existing structures demonstrated to have sufficient strength to resist anticipated tsunami effects, are all potential options for vertical evacuation.

Vertical evacuation solutions can include soil berms, parking garages, community facilities, commercial facilities, school facilities, or existing buildings.

Nonstructural systems and contents located in the levels below the inundation depth should be assumed to be a total loss if the design tsunami occurs. If the building is required to remain functional in the event of a disaster, the loss of lower level walls, nonstructural systems, and contents should be considered in the design of the facility and the selection of possible alternative uses. Critical equipment such as emergency generators and associated fuel storage would need to be located above the anticipated inundation depth or otherwise protected from damage due to inundation.

4.2.1 Existing High Ground

Naturally occurring areas of high ground may be able to be utilized or modified to create a refuge for tsunami vertical evacuation. Large open areas offer easy access for large numbers of evacuees with the added advantage of

avoiding the possible apprehension about entering a building following an earthquake. In addition, most coastal communities have educated their populations to “go to high ground” in the event of a tsunami warning. The topography of the existing high ground should be evaluated for the potential of wave runup or erosion. Some modification of the existing topography may be required to address these issues. In Japan, stairways and ramps have been added to facilitate faster access to areas of naturally occurring high ground.

4.2.2 Soil Berms

If natural high ground is not available, a soil berm can be constructed to raise the ground level above the tsunami runup height, as shown in Figure 4-1. Although care must be taken to protect the sides of a soil berm from the incoming and outgoing tsunami waves, this option can be relatively cost-effective in comparison to building a stand-alone structure.



Figure 4-1 Soil berm in a community park at the Port of Sendai, Japan. Concrete lining on the ocean face deflects incoming waves while sloped sides allow easy access. Map inset identifies the location of berm within the Port (images courtesy of I. Robertson and ASCE, from Chock, et al., 2013b).

To reduce cost, the berm could be constructed using recycled construction materials such as concrete, masonry and asphalt collected from local demolition contractors who would otherwise dump the material in a landfill. The height of the berm must be sufficient to avoid becoming inundated, and

the slope of the sides must allow for ingress. A maximum ramp slope in the range of 1 foot vertical rise to 4 feet horizontal run (1 in 4) is recommended. Soil berms have the added benefit that they are immune to damage from large debris strikes such as shipping containers, barges, and ships, making them suitable for locations near port facilities.

4.2.3 Multi-Story Parking Garages

Parking garages are good candidates for use as vertical evacuation structures. Similar to the example shown in Figure 4-2, most parking garages are open structures that will allow water to flow through with minimal resistance. They can also be open for pedestrian access at any time of the day or night. Interior ramps allow ample opportunity for ingress, and easy vertical circulation to higher levels within the structure. Parking garages can also be used to provide additional community amenities on the top level, including parks, observation decks, and athletic facilities. They are also obvious revenue-generating facilities, especially in areas that attract tourists.



Figure 4-2 Cast-in-place reinforced concrete parking garage in Biloxi, Mississippi after Hurricane Katrina. Open structural systems allow water to pass through with minimal resistance, and interior ramps allow for easy ingress and vertical circulation.

Parking garages, however, tend to be constructed using low-cost, efficient structural systems with minimal redundancy. If designed with higher performance objectives, as required in ASCE/SEI 7-16, and if subjected to additional quality assurance review and construction inspection by local jurisdictions, parking garages could be effective vertical evacuation solutions.

4.2.4 Community Facilities

Vertical evacuation structures could be developed as part of other community-based needs such as community centers, recreational facilities, sports complexes, libraries, museums, and police or fire stations. One such example is shown in Figure 4-3. When not in use as a refuge, facilities such as these can be useful for a variety of functions that enhance the quality of life in a community. When choosing alternative uses for a vertical evacuation facility, consideration should be given to potential impacts that other uses might have on the vertical evacuation function. Potential negative impacts could include clutter that could become debris that disrupts ingress. Limited access after regular operating hours would make it difficult to use a facility for evacuation from a tsunami that could occur at any time of the day or night. Priority should be given to uses with complementary functions, such as accommodations for large numbers of people and 24-hour access.



Figure 4-3 Sports complex. Designed for assembly use, this type of structure can accommodate circulation and service needs for large numbers of people.

4.2.5 Commercial and Residential Facilities

Vertical evacuation structures could be developed as part of business or other commercial facilities including multi-level hotels, restaurants, or retail establishments, as shown in Figure 4-4. For example, if the refuge area is part of a hotel complex, meeting rooms, ballrooms, and exhibit spaces that are located above the tsunami inundation elevation could be used to provide refuge when a tsunami occurs. The apartment building shown in Figure 4-5 served as a vertical evacuation structure in the 2011 Tohoku tsunami. Exterior stairs provided 24-hour access to the upper floors designated as the evacuation refuge.

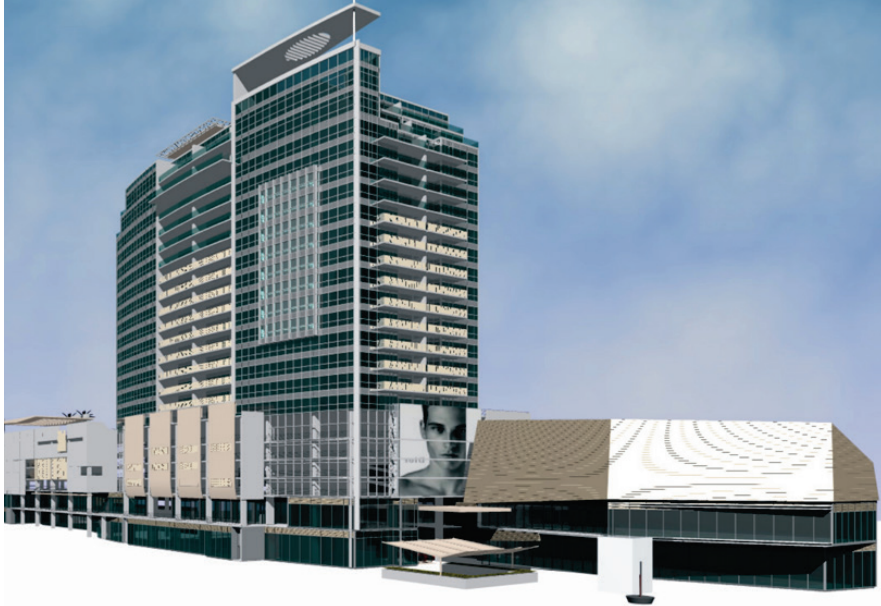

Figure 4-4 Hotel and convention complex. Meeting rooms, ballrooms, and exhibit spaces located above the tsunami inundation elevation can be used to provide areas of refuge.



Figure 4-5 Residential apartment building in Kamaishi, Japan, with a designated refuge area at or above the fourth level.

4.2.6 School Facilities

Similar to community facilities, public and private school facilities have the benefit of providing useful and essential services to the communities in

which they reside. Ongoing construction of schools provides an opportunity and potential funding mechanism for co-located tsunami vertical evacuation structures (see Ocosta Elementary School, Appendix A). This has the added benefit of possible additional public support for projects that increase the safety of school-age children. These buildings must be tall enough, or sited on locally higher ground, so that they are useful as tsunami refuge areas.

4.2.7 Existing Buildings

Historic damage patterns suggest that many structures not specifically designed for tsunami loading can survive tsunami inundation and provide areas of refuge. It is therefore quite possible that some existing structures could serve as vertical evacuation structures or could be made more tsunami-resistant with some modification. An assessment of both the functional needs and structural vulnerabilities would be required to determine if an existing building can serve as a vertical evacuation structure.

In some situations, providing some level of protection is better than none. An example of this concept is used in Honolulu, Hawaii, which has a policy of vertical evacuation. A tsunami evacuation map for Waikiki Beach is shown in Figure 4-6. Orange areas show evacuation zones for typical

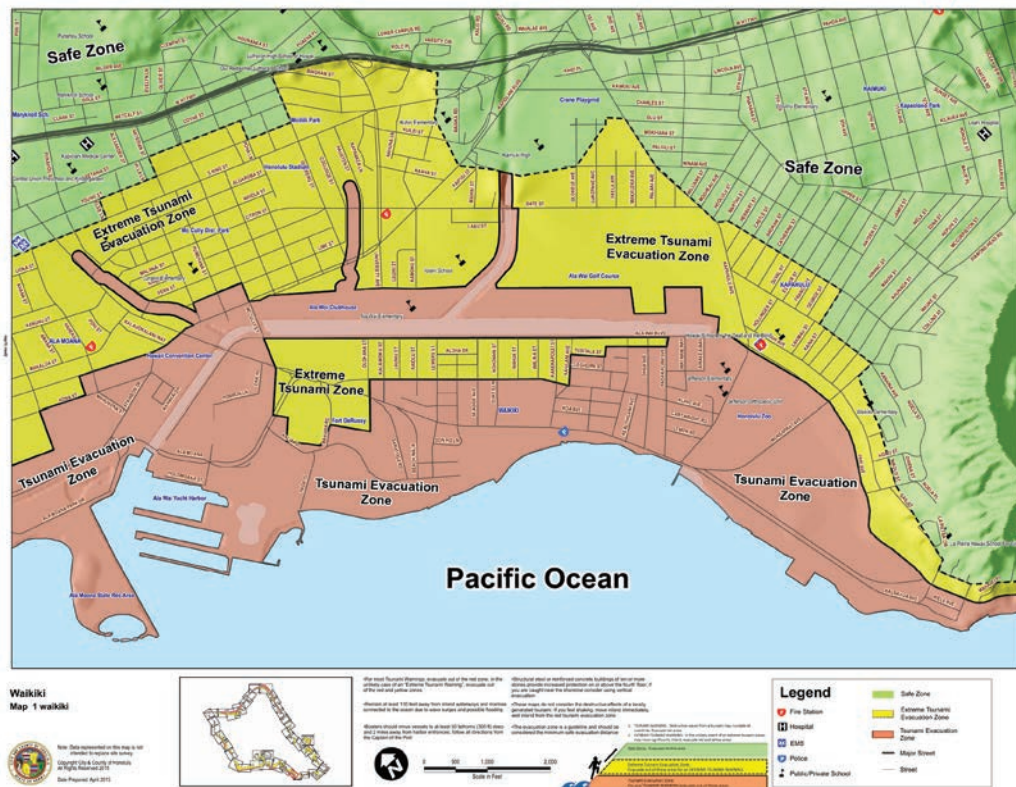

Figure 4-6 Tsunami evacuation map for Waikiki Beach, Honolulu, Hawaii (City and County of Honolulu, 2018).

tsunamis, and yellow areas show evacuation zones for extreme tsunamis. The map includes a note stating that “structural steel or reinforced concrete buildings of ten or more stories provide increased protection on or above the fourth floor,” and hotels in Waikiki have tsunami evacuation plans that include vertical evacuation.

Chapter 5

Siting, Spacing, Sizing, and Elevation Considerations

Implementation of vertical evacuation requires a distribution of structures throughout the community that are suitable for providing refuge from the effects of tsunami inundation, and that are appropriately sized for the population. Ample availability of vertical evacuation refuge options may also reduce the congestion of horizontal evacuation routes and enhance the effectiveness of a community evacuation plan.

This chapter provides guidance on siting, spacing, sizing, and elevation considerations for the distribution of vertical evacuation refuge structures throughout a community

5.1 Siting Considerations

Vertical evacuation structures should be located such that all persons designated to take refuge can reach the structure within the time available between tsunami warning and tsunami inundation. Travel time must also take into consideration vertical circulation within the structure to levels above the tsunami inundation elevation. Structures located at one end of a community may be difficult for some users to reach in a timely fashion. Routes to the structure should be easily accessible and well-marked with approved tsunami warning signs.

Vertical evacuation structures should be located such that all persons designated to take refuge can reach the structure within the time available between tsunami warning and tsunami inundation.

Location of vertical evacuation structures within a community should take into account potential hazards in the vicinity of a site that could jeopardize the safety of the structure, and should consider the natural behaviors of persons attempting to avoid tsunami inundation.

5.1.1 Warning, Travel Time, and Spacing

The National Tsunami Warning Center (NTWC) in Alaska, and the Pacific Tsunami Warning Center (PTWC) in Hawaii, monitor potential tsunamis and warn affected populations of an impending tsunami. Table 5-1 summarizes approximate warning times associated with the distance between a tsunami-genic source and the site of interest. A far-source-generated tsunami originates from a source that is far away from the site, and could have 3 hours or more of advance warning time. A near-source-generated tsunami

originates from a source that is close to the site, and could have 60 minutes or less of advance warning time. Sites experiencing near-source-generated tsunamis will generally feel the effects of the triggering event (e.g., shaking caused by a near-source earthquake), and these effects will likely be the first warning of the impending tsunami. A mid-source-generated tsunami is one in which the source is somewhat close to the site of interest, but not close enough for the effects of the tsunami generating event to be felt at the site. Mid-source-generated tsunamis would be expected to have between one and three hours of advance warning time.

Table 5-1 Tsunami Sources and Approximate Warning Times

Location of Source	Approximate Warning Time (<i>t</i>)
Far-source-generated tsunami	$t > 3$ hours
Mid-source-generated tsunami	1 hour $< t < 3$ hours
Near-source-generated tsunami	$t < 60$ min

Maximum spacing between vertical evacuation structures depends on warning time, ambulatory speed, and the surrounding population density.

Consideration must be given to the time it would take for designated occupants to reach a refuge. To determine the maximum spacing of tsunami vertical evacuation structures, the critical parameters are warning time and ambulatory capability of the surrounding community. Once maximum spacing is determined, size must be considered, and population becomes an important parameter. Sizing considerations could necessitate an adjustment in the number and spacing of vertical evacuation structures if it is not feasible to size the resulting structures large enough to accommodate the surrounding population at the maximum spacing. Sizing considerations are discussed in Section 5.2.

The average, healthy person can walk at approximately 4 mph. Portions of the population in a community, however, may have restricted ambulatory capability due to age, health, or disability. The average pace of a mobility-impaired population can be assumed to be about 2 mph.

Assuming a 3-hour warning time associated with far-source-generated tsunamis, vertical evacuation structures would need to be located a maximum of 6 miles from any given starting point. This would result in a maximum spacing of approximately 12 miles between structures. Similarly, assuming a 30 minute warning time, vertical evacuation structures would need to be located a maximum of 1 mile from any given starting point, or 2 miles between structures. Shorter warning times would require even closer spacing. Table 5-2 summarizes maximum spacing of vertical evacuation structures assuming the ability of mobility-impaired populations to sustain travel over the entire duration of the available warning time. In setting

maximum spacing between vertical evacuation structures, however, consideration should also be given to the potentially limited absolute range of travel associated with mobility-impaired populations.

Table 5-2 Maximum Spacing of Vertical Evacuation Structures Based on Ambulatory Speed and Warning Time

Warning Time	Ambulatory Speed	Travel Distance	Maximum Spacing
3 hours	2 mph*	6 miles	12 miles
1 hour	2 mph*	2 miles	4 miles
30 minutes	2 mph*	1 mile	2 miles
15 minutes	2 mph*	½ mile	1 mile

* Based on the average pace for mobility-impaired populations, consideration should be given to the potentially limited absolute range of travel associated with mobility-impaired populations.

5.1.2 Ingress and Vertical Circulation

Tsunami vertical evacuation structures should be spaced such that people will have adequate time not only to reach the structure, but to enter and move vertically within the structure to areas of refuge that are located above the anticipated level of tsunami inundation.

Increased travel times may need to be considered if obstructions exist, or could occur, along the travel or ingress route. Unstable or poorly secured structural or architectural elements that collapse in and around the entrance, or the presence of contents associated with the non-refuge uses of a structure, could potentially impede ingress. Allowance for parking at a vertical evacuation refuge may decrease travel time to the refuge, but could complicate access if traffic jams occur.

Stairs or elevators are traditional methods of ingress and vertical circulation in buildings. If elevators are to be used to reach the refuge levels, they will need to be designated as critical non-structural components, requiring design for immediate operation after the preceding earthquake and potential power loss. Ramps, such as the ones used in sporting venues and parking garages, however, can be more effective for moving large numbers of people to refuge areas in a structure. Estimates of travel time may need adjustment for different methods of vertical circulation. Disabled users may need to travel along a special route that accommodates wheelchairs (e.g., a wrap-around ramp), and those with special needs may require assistance from others to move within the structure.

When locating vertical evacuation structures, natural and learned behaviors of evacuees should be considered. Many coastal communities have educated

Travel time to safety should include:

- traveling from original location to the vertical evacuation site;
- accessing the structure; and
- vertical circulation to the appropriate level of the structure.

their populations to “go to high ground” in the event of a tsunami warning. Also, a natural tendency for evacuees will be to migrate away from the shore. Vertical evacuation structures should therefore be located on the inland side of evacuation zones and should take advantage of naturally occurring topography that would tend to draw evacuees towards them. Figure 5-1 illustrates an arrangement of vertical evacuation structures in a hypothetical community based on these principles.

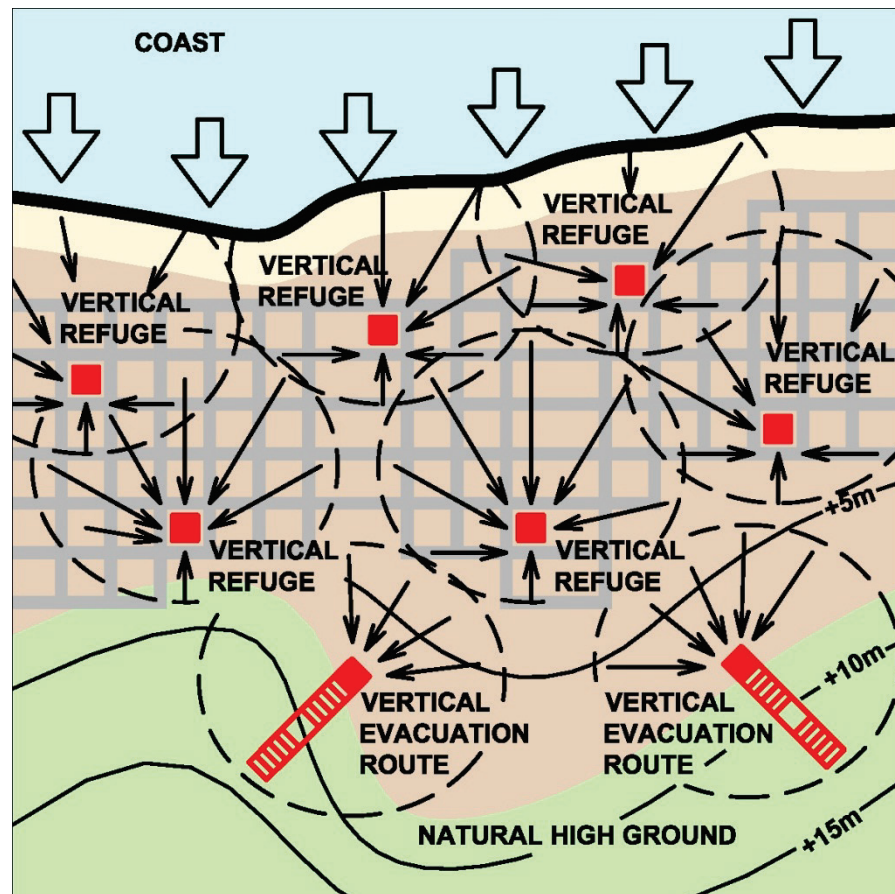

Figure 5-1 Vertical evacuation refuge locations considering travel distance, evacuation behavior, and naturally occurring high ground. Arrows show anticipated vertical evacuation routes.

5.1.3 Consideration of Site Hazards

Where possible, vertical evacuation structures should be located away from potential hazards that could result in additional damage to the structure and reduced safety for the occupants.

Special hazards in the vicinity of each site should be considered in locating vertical evacuation structures. Site hazards include breaking waves, sources of large waterborne debris, sources of waterborne hazardous materials, liquefaction, landslides, and the potential for collapsed structures and downed power lines in the immediate vicinity. Where possible, vertical evacuation structures should be located away from potential hazards that could result in additional damage to the structure and reduced safety for the

occupants. Due to limited availability of potential evacuation sites, and limitations on travel and mobility of the population in a community, some vertical evacuation structures may need to be located at sites that would be considered less than ideal. Figure 5-2 illustrates adjacent site hazards that could exist in a hypothetical coastal community.

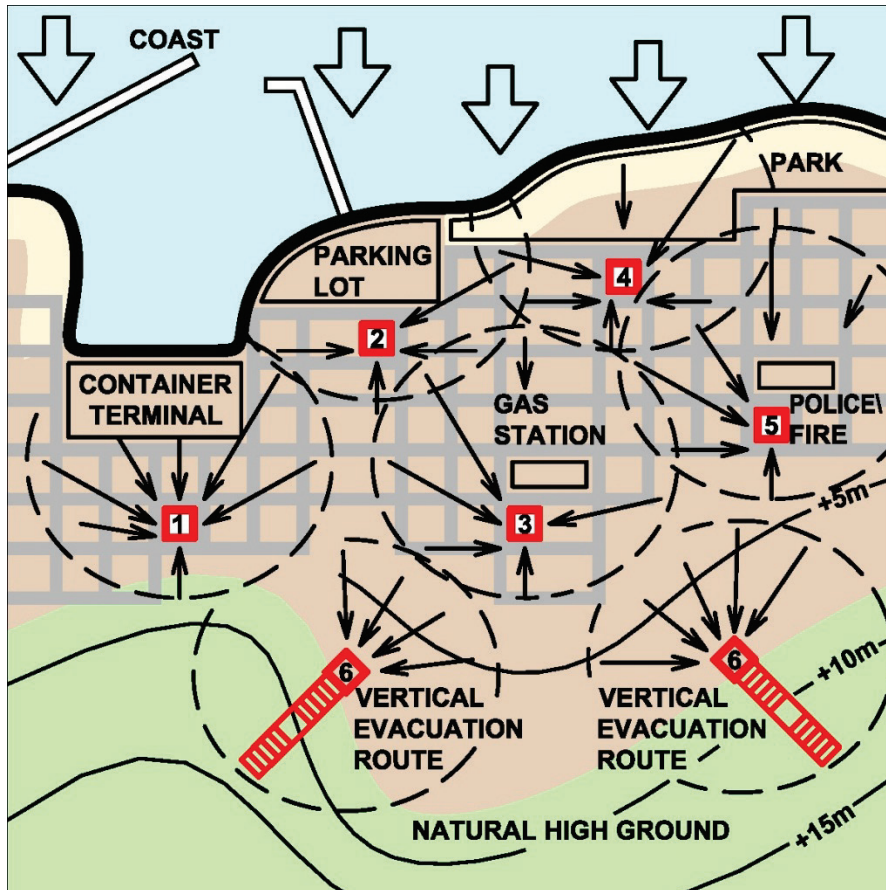

Figure 5-2 Site hazards adjacent to vertical evacuation structures (numbered locations). Arrows show anticipated vertical evacuation routes.

Wave breaking takes place as the water depth decreases. In the design of usual coastal structures (e.g., breakwaters, seawalls, jetties), critical wave forces often result from breaking waves. In general, tsunamis break offshore. In the case of very steep terrain, however, they can break right at the shoreline, which is known as a collapsing breaker.

Forces from collapsing breakers can be extremely high and very uncertain. Location of vertical evacuation structures within the tsunami wave-breaking zone poses unknown additional risk to the structure. While the possibility of tsunami wave breaking at an on-shore location is not zero, it is considered to be very rare. For these reasons, recommended sites for vertical evacuation

structures are located inland of the wave-breaking zone, and wave breaking forces are not considered in ASCE/SEI 7-16 tsunami design provisions.

In Figure 5-2, vertical evacuation structures are located some distance inland from the shoreline. Structure No. 1 is located adjacent to a harbor and container terminal. Impact forces from ships, barges, boats, shipping containers and other waterborne debris have the potential to become very large. Locations with additional sources of large, possibly buoyant debris increase the chances of impact by one or more waterborne missiles, and increase the potential risk to the structure. It would be better if this structure was sited away from the harbor and container terminal. If there is no alternative location available to serve this area of the community, this structure would need to be designed for potential impact from the shipping containers and boats likely to be present during tsunami inundation. ASCE/SEI 7-16 provides a site hazard assessment tool for determining whether or not a particular location is at risk of impact by boats or shipping containers.

Structure No. 2 is located off to the side of the harbor and adjacent to a parking lot. This structure would need to be designed for debris consistent with the use of the parking lot and surrounding areas, which could include cars, trucks, and recreational vehicles. Impacts from these types of floating debris are considered in ASCE/SEI 7-16 for design of all structures in the tsunami design zone.

Structure No. 3 is immediately adjacent to a gas station. In past tsunamis, ignition of flammable chemicals or other floating debris has resulted in significant risk for fire in partially submerged structures. Depending on the potential for fuel leakage from this station in the event of a tsunami (or a preceding earthquake), this structure would need to be designed with fire resistive construction and additional fire protection.

Structure No. 4 is adjacent to a waterfront park facility. This location can be ideal, as the potential for waterborne debris can be relatively low. Possible hazards could include debris from park structures, naturally occurring driftwood, or larger logs from downed trees, all of which are considered in ASCE/SEI 7-16 design provisions. This area has a higher potential for tourists and visitors unfamiliar with the area and would require additional signage to inform park users what to do and where to go in the event of a tsunami warning.

Structure No. 5 is adjacent to an emergency response facility. Co-locating at such facilities can provide opportunities for direct supervision by law

enforcement and monitoring and support of refuge occupancies by other emergency response personnel.

Structure No. 6 is intended to aid evacuees in taking advantage of naturally occurring high ground at two locations.

5.2 Sizing Considerations

Sizing of a vertical evacuation structure depends on the intended number of occupants, the type of occupancy, and the duration of occupancy. The number of occupants will depend on the surrounding population and the spacing and number of vertical evacuation structures located in the area. Duration of occupancy will depend on the nature of the hazard and the intended function of the facility as a short-term refuge or long-term shelter.

Sizing of vertical evacuation structures depends on the intended number of occupants, the type of occupancy, and the duration of occupancy.

5.2.1 Services and Occupancy Duration

A vertical evacuation structure is typically intended to provide a temporary place of refuge during a tsunami event. While tsunamis are generally considered to be short-duration events (i.e., pre-event warning period and event lasting about 8 to 12 hours), tsunamis include several cycles of waves. The potential for abnormally high tides and coastal flooding can last as long as 24 hours.

A vertical evacuation structure must provide adequate services to evacuees for their intended length of stay. As a short term refuge, services can be minimal, including only limited space per occupant and basic sanitation needs. Alternatively, a vertical evacuation structure could be used as a shelter to provide accommodations and services for people whose homes have been damaged or destroyed. As a minimum, this would require an allowance for more space for occupants, supplies, and services. It could also include consideration of different post-event rescue and recovery activities, and evaluation of short- and long-term medical care needs. Guidance on basic community sheltering needs is not included in this document, but can be found in FEMA P-361, *Safe Rooms for Tornadoes and Hurricanes: Guidance for Community and Residential Safe Rooms* (FEMA, 2015b).

Choosing to design and construct a vertical evacuation structure primarily for short-term refuge, or to supply and manage it as a shelter to house evacuees for longer periods of time, is an emergency management issue that must be decided by the state, municipality, local community, or private owner in coordination with the emergency management agency having jurisdiction over the location of the refuge.

5.2.2 Square Footage Recommendations from Available Sheltering Guidelines

Square footage recommendations are available from a number of different sources, and vary depending on the type of hazard and the anticipated duration of occupancy. The longer the anticipated stay, the greater the minimum square footage recommended.

A shelter for mostly healthy, uninjured people for a short-term event would require the least square footage per occupant. A shelter intended to house sick or injured people, or to provide ongoing medical care, would require more square footage to accommodate beds and supplies. For longer duration stays, even more square footage is needed per occupant for minimum privacy and comfort requirements, and for building infrastructure, systems, and services needed when housing people on an extended basis.

Table 5-3, Table 5-4, and Table 5-5 summarize square footage recommendations from different sources, including the International Code Council/National Storm Shelter Association, ICC 500-2014, *Standard for the Design and Construction of Storm Shelters* (ICC/NSSA, 2014), FEMA P-361 (FEMA, 2015b), and American Red Cross Publication No. 4496, *Standards for Hurricane Evacuation Shelter Selection* (ARC, 2002).

Table 5-3 Square Footage Recommendations – ICC 500-2014 *Standard for the Design and Construction of Storm Shelters* (ICC/NSSA, 2014)

Hazard or Duration	Minimum Required Usable Floor Area in Sq. Ft. per Occupant
Tornado	
Standing or seated	5
Wheelchair	10
Bedridden	30
Hurricane	
Standing or seated	20
Wheelchair	20
Bedridden	40

Table 5-4 Square Footage Recommendations – FEMA P-361 *Design and Construction Guidance for Community Shelters* (FEMA, 2015b)

Hazard or Duration	Recommended Minimum Usable Floor Area in Sq. Ft. per Occupant
Tornado	5
Hurricane	10

**Table 5-5 Square Footage Recommendations – American Red Cross
Publication No. 4496 (ARC, 2002)**

Hazard or Duration	Recommended Minimum Usable Floor Area in Sq. Ft. per Occupant
Short-term stay (i.e., a few days)	20
Long-term stay (i.e., days to weeks)	40

The number of standing, seating, wheelchair, or bedridden spaces should be determined based on the specific occupancy needs of the facility under consideration. When determining usable floor area, ICC 500-2014 includes the following adjustments to gross floor area:

- Usable floor area is 50 percent of gross floor area in shelter areas with concentrated furnishings or fixed seating.
- Usable floor area is 65 percent of gross floor area in shelter areas with unconcentrated furnishings and without fixed seating.
- Usable floor area is 85 percent of gross floor area in shelter areas with open plan furnishings and without fixed seating.

5.2.3 Recommended Minimum Square Footage for Short-Term Vertical Evacuation Refuge Structures

For short-term refuge in a tsunami vertical evacuation structure, the duration of occupancy should be expected to last between 8 to 12 hours, as a minimum. Because tsunami events can include several cycles of waves, there are recommendations that suggest evacuees should remain in a tsunami refuge until the second high tide after the first tsunami wave, which could occur up to 24 hours later.

Based on square footage recommendations employed in the design of shelters for other hazards, the recommended minimum square footage for a short-term vertical evacuation refuge structure is 10 square feet per occupant. It is anticipated that this density will allow evacuees room to sit down without feeling overly crowded for a relatively short period of time, but would not be considered appropriate for longer stays that included sleeping arrangements. It allows some flexibility in case there are more occupants than anticipated, thus avoiding the possibility of turning people away because of lack of space in the refuge area. This number should be adjusted up or down depending on the specific occupancy needs of the refuge under consideration.

The recommended minimum square footage for a short-term vertical evacuation refuge structure is 10 square feet per occupant.

5.3 Elevation Considerations

Recommended minimum refuge elevation is the maximum anticipated tsunami inundation elevation, plus 30%, plus 10 feet (3 meters) or one story, whichever is greater.

To serve effectively as a vertical evacuation structure, it is essential that the area of refuge be located well above the maximum tsunami inundation level anticipated at the site. Determination of a suitable elevation for tsunami refuge must take into account the uncertainty inherent in estimation of the tsunami runup elevation, possible splash-up during impact of tsunami waves, and the anxiety level of evacuees seeking refuge in the structure.

Unfortunately a number of designated evacuation structures in Japan were inundated during the Tohoku tsunami, leading to loss of life of many evacuees. To account for this uncertainty, the magnitude of tsunami force effects in ASCE/SEI 7-16 is determined assuming a maximum tsunami inundation elevation that is 30% higher than values predicted by site-specific tsunami inundation analysis.

Because of the high consequence of potential inundation of the tsunami refuge area, ASCE/SEI 7-16 requires that the elevation of tsunami refuge areas in vertical evacuation structures include an additional allowance for *freeboard*, or separation between the level of water and level of refuge. The required minimum freeboard is one story height, or 10 feet (3 meters), whichever is greater, above the tsunami inundation elevation used in tsunami force calculations. As illustrated in Figure 5-3, the required minimum elevation for a tsunami refuge area is, therefore, the maximum tsunami inundation elevation anticipated at the site, plus 30%, plus 10 feet (3 meters) or one floor, whichever is greater. This should be treated as an absolute minimum, with additional conservatism strongly encouraged.

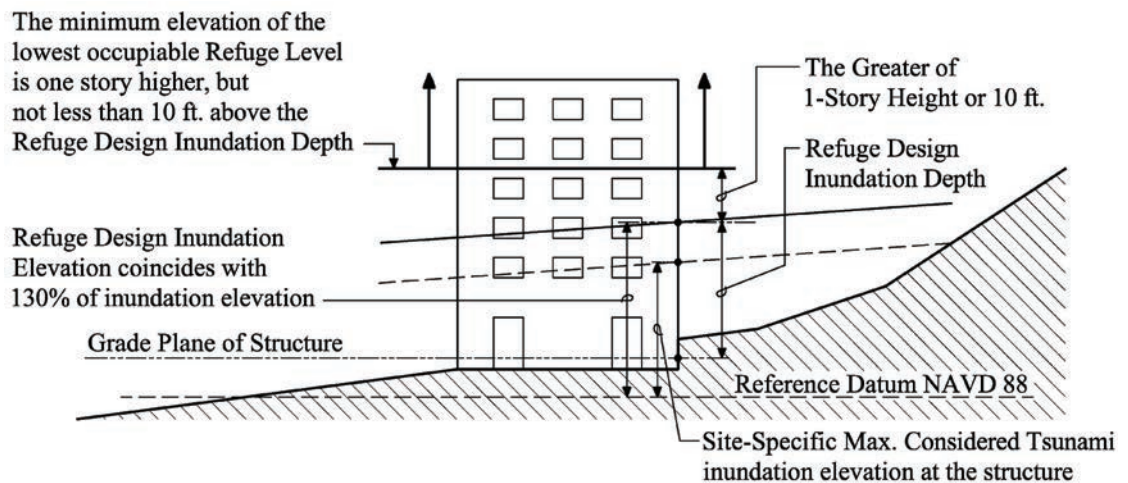

Figure 5-3 Illustration of requirements for minimum refuge level elevation (ASCE, 2016). Printed with permission from ASCE.

5.4 Size of Vertical Evacuation Structures

Given the number and spacing of vertical evacuation structures, and the population in a given community, the minimum size can be determined based on square footage recommendations for the intended duration and type of occupancy. Consideration of other functional needs, such as restrooms, supplies, communications, and emergency power, should then be added to the overall size of the structure.

Chapter 6

Operation and Maintenance

This chapter describes operational and maintenance considerations for vertical evacuation refuge structures, including the development of a Facility Operations Plan, the need for a pre-tsunami public education plan, and activation of the facility in the event of a tsunami warning.

6.1 Facility Operations Plan

A Facility Operations Plan should be developed before a vertical evacuation refuge is put into service. Such a plan includes instructions on how the vertical evacuation structure will open after a warning, how it will operate, what supplies will be stocked, and how people will leave the structure when the threat is over. Answers to these questions will depend on the type of vertical evacuation structure chosen. Logistics for engineered high ground will be different than those for a vertical evacuation structure co-located with other community facilities.

Especially in the case of a near-source-generated tsunami, it is possible that few, or no, local government staff will be immediately available to operate a facility, if not previously assigned. A Facility Management Team that is responsible for emergency facility operations as well as overseeing regular maintenance may be necessary. Members of the local public works, parks, and emergency management staff would be candidates for this team. Additionally, a Community Emergency Response Team (CERT), if constituted, can play an important role in a tsunami response plan. CERT members could be used to help with maintenance of the vertical evacuation structure, and in the case of an actual tsunami, CERT members could operate the vertical evacuation structure. Information on organizing and funding a CERT is available at <https://www.ready.gov/community-emergency-response-team>. CERT training is also available from FEMA's Emergency Management Institute.

The Facility Operations Plan should cover the needs of a community from the first issue of a tsunami watch, tsunami advisory, or tsunami warning, until an "all clear" announcement is issued. Plans for operating and staffing a vertical evacuation structure should take into consideration evolving capabilities and smart building technologies that could be used to remotely provide access to a structure.

A Facility Operations Plan should include instructions on:

- how the vertical evacuation structure will open after a warning,
- how it will operate,
- what supplies will be stocked, and
- how people will leave the structure when the threat is over.

A Facility Management Team may be needed to oversee regular maintenance and emergency operations at the facility.

6.2 Pre-Tsunami Public Education

Pre-tsunami education is critical to prepare the population to act quickly and appropriately in the event of a tsunami. Residents and tourists must understand the importance of the tsunami threat. They also need to know how to get more information about tsunamis and what warning systems are available. Whether a tsunami source is near or far, people in the evacuation zone must respond immediately when a warning is issued, or when strong ground shaking is felt.

According to research, door-to-door outreach and evacuation drills were the most effective pre-tsunami public education techniques.

A systematic study of various public education strategies was carried out by the National Tsunami Hazard Mitigation Program in a pilot study of Seaside, Oregon, documented in an Oregon Department of Geology and Mineral Industries Open File Report (Connor, 2005). Results are summarized in Figure 6-1. According to this study, door-to-door outreach and evacuation drills were the most effective strategies for public education. Note that the total of all possible responses in the figure is more than 100% because respondents were given the option to choose more than one answer.

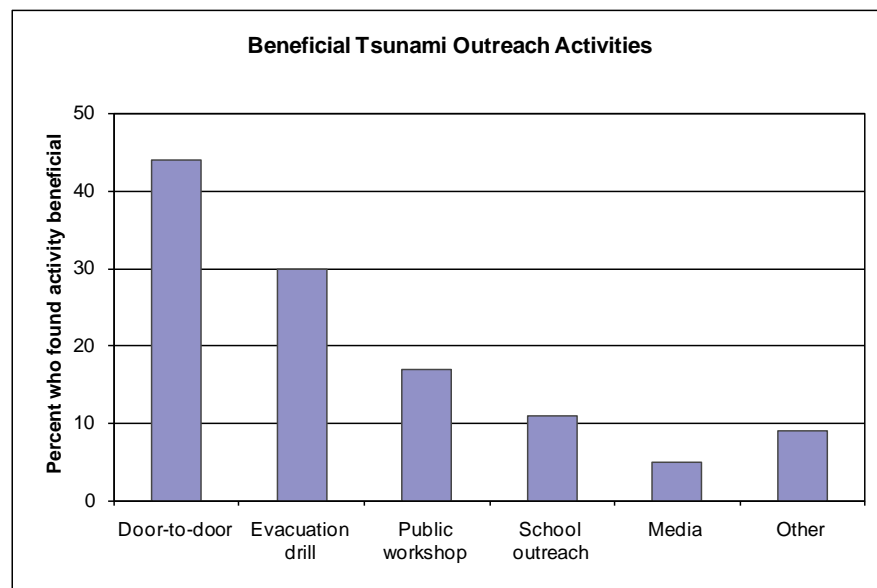

Figure 6-1 Results of Seaside, Oregon study showing the perceived effectiveness of various public education strategies (data from Connor, 2005).

As demonstrated Seaside, Oregon, tsunami evacuation drills are an important part of the education process. They help people respond quickly and efficiently to a tsunami warning and generate local media attention to the issue. This is particularly important if a major earthquake is expected to trigger a near-source-generated tsunami. The tsunami may arrive within minutes, so it is imperative for people to instinctively know where to

evacuate immediately after the shaking stops. Having a Community Emergency Response Team (CERT) could help with public education and the conduct of tsunami evacuation drills.

6.3 Tsunami Warnings

For an impending near-source-generated tsunami, the first warning may be strong ground shaking associated with the triggering earthquake. This will be followed within minutes by a warning from one of the tsunami warning centers. The earthquake shaking, however, should serve as the trigger for evacuation, and the Facility Operations Plan should be activated when strong ground shaking is felt.

In the case of a dangerous mid- or far-source-generated tsunami, the ground shaking may not be felt, but a tsunami alert (i.e., warning, advisory, watch, or other information) will be issued by the National Tsunami Warning Center (NTWC) for Alaska, Washington, Oregon, and California, and by the Pacific Tsunami Warning Center (PTWC) for Hawaii, American Samoa, Guam, Northern Mariana Islands, Puerto Rico, and the U.S. and British Virgin Islands, if a tsunami threat is imminent. As water level data are collected, the alert will be expanded incrementally, restricted, or cancelled. The warning should provide adequate time for immediate response activities to be initiated in accordance with the Facility Operations Plan.

When the Facility Operations Plan is activated, responsible personnel, such as the Facility Management Team, should begin performing tasks such as:

- coordinating with the appropriate Emergency Management Agency on disseminating public warnings to the community;
- alerting the public to leave the evacuation zone and head to vertical evacuation structures or high ground;
- ensuring that the tsunami vertical evacuation structure is open and that access to the refuge has not been blocked by earthquake damage to nonstructural components of the building;
- assist evacuees, especially those with limited mobility, in accessing the refuge levels of the tsunami vertical evacuation structure;
- reassuring evacuees that the refuge structure has been specifically designed, or assessed, for potential earthquake and tsunami loads and effects;
- distributing supplies, administering first aid;
- communicating with emergency managers, and monitoring the tsunami from within the facility; and

- resisting the temptation to allow evacuees to leave the refuge area before the “all clear” signal has been given by emergency managers.

6.4 Opening the Vertical Evacuation Structure

The responsibility of opening the refuge structure must be clearly assigned in the Facility Operations Plan and should include backup personnel. Ideally, the facility should be configured so that it is always accessible or can be entered without emergency personnel. Figure 6-2 shows a concrete apartment building that was designated as a vertical evacuation structure in Minamisanriku, Japan during the 2011 Tohoku tsunami. An external staircase and elevator provided direct access to the large evacuation area on the roof.



Figure 6-2 Reinforced concrete apartment building designated as a vertical evacuation structure in Minamisanriku, Japan, 2011 Tohoku tsunami.

Especially in the case of a near-source-generated event, emergency personnel may not be able to get to the vertical evacuation structure immediately. If people arrive at a facility but cannot enter, they will be confused, angry, or frightened. Consideration should be given to providing an emergency “glass break” unlock feature or remote unlocking system that can be activated by emergency managers.

Every vertical evacuation structure will have a maximum recommended occupancy. This number should be clearly posted. A community may have to educate their able-bodied population to bypass a crowded vertical evacuation structure and continue on to an alternative site, including adjacent structures, the nearest high ground, or areas further inland. During a tsunami warning and evacuation, however, there may not be time to reach alternative safe locations before the anticipated arrival of the tsunami. Also, adjacent refuge structures could be similarly crowded or unknown obstacles may exist on travel routes to alternative locations.

Refuge areas are designed for assembly live loads of 100 pounds per square foot. The recommended sizing of 10 square feet per person in a refuge is intended to provide some measure of comfort during the time spent in the facility, and is not a limit for safe vertical loading at the refuge level. Occupancy limits should be waived if necessary to save lives in the event of an emergency.

Planning and operation of a vertical evacuation structure should include consideration of pets. Many people will not want to leave their pets behind during a disaster. The policy regarding pets should be carefully considered and clearly stated in the Facility Operations Plan. Information about accommodation of pets (or not) should be clearly posted to avoid misunderstandings and hostility when evacuees arrive at the facility. It should also be included in public education materials.

It is important to discourage people from using cars to evacuate after a tsunami warning, especially in a near-source-generated event. Figure 6-3 shows severe road damage resulting from the 1964 Alaska earthquake, demonstrating that driving to vertical evacuation structures after a near-source-generated tsunami may not be feasible.



Figure 6-3 Roadway damage as a result of the 1964 Alaska earthquake (photo courtesy of the U.S. Geological Survey).

Vehicular evacuation in Waikiki during the 1986 tsunami warning resulted in major traffic congestion that trapped people on surface roads at the time that tsunami waves arrived. Fortunately, this event did not result in major inundation so no lives were lost, but during a maximum considered tsunami event, numerous fatalities would have occurred. Many of the fatalities

during the 2011 Tohoku tsunami were from people caught in their vehicles during the incoming wave.

In addition, parking at vertical evacuation structures can create problems, such as blocking or constricting access to the site, preventing users from getting to the structure before the tsunami arrives. Parked vehicles can also become waterborne debris that can cause additional damage to the structure. Policies about vehicular evacuation and parking need to be developed as part of the Facility Operations Plan and included in public education materials.

6.5 Operating the Vertical Evacuation Structure

The primary purpose of a vertical evacuation refuge structure is short-term escape from tsunami inundation. In most areas, damaging waves will occur within the first 5 to 12 hours, though the potential for abnormally high tides and coastal flooding can last as long as 24 hours. Depending on the local topography and the amount of scour around the building, it may take some time for water around the refuge to drain. Access by emergency responders will also be hampered by debris in roadways, collapsed buildings, and uprooted trees. Many evacuees during the 2011 Tohoku tsunami were trapped in refuge structures for up to two days after the tsunami (Fraser, et al. 2012).

If supplies are stored onsite, the Facility Management Team must be responsible for making sure they are stocked, accessible during emergencies, and rotated at regular intervals.

Provisions for supplies should be considered if at all possible. When supplies are provided, storage areas will need to be included in the design. If supplies are stored onsite, the Facility Management Team must be responsible for making sure they are stocked, accessible during emergencies, and rotated at regular intervals. Security measures to protect them when the vertical evacuation structure is not in use should also be in place.

If possible, a vertical evacuation refuge structure should contain, as a minimum, the following:

- water sufficient for the capacity and planned duration of occupancy (can be supplied by locating the building water storage tank at or above the refuge level);
- non-perishable emergency rations sufficient for the capacity and planned duration of occupancy (most people can survive for a number of days with limited or no food);
- flashlights with continuously charging batteries, or flashlights with hand-crank charging (one flashlight per 10 shelter occupants);
- fire extinguishers appropriate for use in a closed environment with human occupancy (number required based on occupancy type);

- first-aid kits rated for the refuge occupancy;
- NOAA weather radio with continuously charging batteries;
- radio with continuously charging batteries (or solar or mechanical charging) for receiving commercial radio broadcasts;
- supply of extra batteries to operate radios and flashlights; and
- audible sounding device (e.g., canned air horn) that continuously charges (or operates without a power source) to signal rescue workers if shelter egress is blocked.

Ideally, a vertical evacuation structure would be stocked with adequate supplies for the full duration of occupancy. However, it is better to have a facility with few supplies than to have no facility at all. Figure 6-4 shows a vertical evacuation structure in Japan with little or no capacity for storage of supplies, but is intended to keep people at a safe elevation above tsunami inundation.



Figure 6-4 Vertical evacuation refuge structure at Shirahama Beach Resort, Japan, with limited capacity for storage of supplies (photo courtesy of N. Shuto).

In a near-source-generated tsunami that is likely to be preceded by an earthquake, major destruction of the surrounding area due to the earthquake ground shaking can be expected. To facilitate public sanitation and ongoing communication with emergency personnel, the following special utilities and equipment should be considered for tsunami vertical evacuation refuge facilities:

- **On-site sanitation facilities that function without power, water supply, and possibly waste disposal.** Although sanitation facilities may be damaged during a tsunami, locating a vertical evacuation structure at, or near, a pump station would allow the system to have some capacity during the event.
- **At least one means of backup communication.** Because telephone service is likely to be disrupted, backup communication equipment such as satellite phones, ham radios, cellular telephones, citizen band radios, or emergency radios capable of reaching police, fire, or other emergency personnel should be provided. If cell phones are relied upon for communications, a signal amplifier should be provided to boost cellular signals from within the vertical evacuation structure. It should be noted that cellular systems might be compromised by loss of cell towers or become overwhelmed in the hours immediately following an event if regular telephone service has been interrupted.
- **A battery-powered radio transmitter or signal-emitting device that can be used to signal the location of the facility to local emergency personnel.** The location of vertical evacuation refuge sites should be communicated to police, fire, and other local rescue personnel when the refuge is activated, in case the occupants become trapped inside the refuge or stranded at the site.
- **Emergency power to meet minimum lighting and ventilation needs.** In case of disruption in electrical service, a solar-powered battery storage system is recommended as a backup power source because such a system can be located and fully protected within the vertical evacuation structure. If a backup power supply is not contained within the vertical evacuation structure itself, it should be located in a structure designed to the same tsunami-resistant criteria.

6.6 Leaving the Vertical Evacuation Structure

It is important for occupants to stay in a vertical evacuation structure until local officials declare it safe to leave. After the tsunami waves have subsided, other hazards, such as chemical spills or fire, may still exist in the surrounding area. Public education programs should stress the importance of remaining in the refuge structure until an “all-clear” announcement is received, and should warn people of the potential danger from successive waves.

The Facilities Operation Plan should designate who has the authority to issue an “all clear” announcement, including backup personnel. If there is no

communication with the outside world and no emergency management personnel at the facility, someone on site must be provided with information needed to make that determination. Copies of the Facilities Operation Plan should be available within the refuge area along with posted signs to assist evacuees in the event that no emergency management personnel are on site.

The Facilities Operation Plan should designate who has the authority to issue an "all clear" announcement and release occupants from the refuge structure.

Once it has been determined that occupants can leave a vertical evacuation structure, local officials will need to advise evacuees as to whether or not they will be allowed to return to their homes, or if long-term sheltering or evacuation to another area will be necessary.

6.7 Maintenance

The Facility Operations Plan should include a maintenance plan designating a schedule for regular maintenance of the facility, including an inventory checklist for emergency supplies, and rotation of provisions. The Facility Management Team should be responsible for ensuring that regular maintenance is performed. In addition, signage needs to be kept current. It is not uncommon for tsunami evacuation signs to be stolen, and they need to be replaced as soon as possible.

The Facility Operations Plan should include a plan for regular maintenance of the facility, including an inventory checklist for emergency supplies, and rotation of provisions.

After a tsunami event, the facility will need to be assessed for damage by appropriate design professionals, evaluated for feasibility of continued use, repaired, cleaned, and re-stocked, as necessary.

6.8 Long-Term Issues

The community's needs should be periodically reassessed because the population may increase or decrease, new hazards may be discovered, or the built environment might have changed. Every few years, the community should reassess its hazard and risk, review emergency response plans, and re-evaluate the need for vertical evacuation structures.

Chapter 7

Tsunami Hazard Assessment

Tsunami hazard in a region is a combination of the presence of a geophysical tsunami source, exposure to tsunamis generated by that source, and the extent of inundation that can be expected as a result of a tsunami reaching the site. Inundation is a complex process influenced by many factors. These include the source characteristics that determine the nature of the initially generated waves, the bathymetry that transforms the waves as they propagate to the shoreline, the topography, structures, and other objects encountered by the waves, the presence of debris, and the temporal variation in each of these factors caused by the impact of successive waves. In general, the physics of tsunami inundation is time-dependent, three-dimensional, and highly uncertain.

The impacts of tsunami hazard on a coastal community are a function of the time it takes a tsunami to propagate from a source to the site, the extent of tsunami inundation, flow depth, flow velocity, and presence of waterborne debris.

This chapter provides an overview of current tsunami hazard modeling and inundation mapping through nationally coordinated efforts such as the National Oceanic and Atmospheric Administration (NOAA) Tsunami Program and the National Tsunami Hazard Mitigation Program (NTHMP). It describes the characterization of tsunami hazard for design, and the availability of tsunami inundation parameters for use in design.

7.1 Tsunami Modeling and Inundation Mapping

Site-specific inundation models and model-derived products, including maps, are essential for reliable tsunami hazard assessment. The National Oceanic and Atmospheric Administration (NOAA) Tsunami Program and the National Tsunami Hazard Mitigation Program (NTHMP) have been engaged in closely related modeling efforts. The NOAA Tsunami Program is focused on the development of the NOAA Tsunami Forecast System (Titov, et al., 2005). The NTHMP Hazard Assessment effort is working on the development of inundation maps for emergency management programs (González, et al., 2005). Both efforts are fundamentally dependent on tsunami numerical modeling technology.

The National Oceanic and Atmospheric Administration (NOAA) Tsunami Program and the National Tsunami Hazard Mitigation Program (NTHMP) have been engaged in closely related modeling efforts.

Tsunami modeling studies generally result in products that include a spatial mapping of the model output in either static or animated form. Primary tsunami wave parameters include the flow depth $h(x,y,t)$ and associated current velocity components $u(x,y,t)$ and $v(x,y,t)$. A Geographic Information System (GIS) database of these output parameters and associated input data (e.g., model computational grids and source parameters) can be used to derive parameters such as flow depth, velocity, and momentum flux. State emergency managers should be contacted to determine the status of local tsunami hazard modeling, mapping, and data.

7.2 The NOAA Tsunami Program: Forecast Modeling and Mapping

As part of the Tsunami Forecasting System, NOAA has developed site-specific inundation models at 75 sites shown in Figure 7-1. The National Center for Tsunami Research (NCTR) at the Pacific Marine Environmental Laboratory (PMEL) in Seattle, Washington, has the primary responsibility for this forecast modeling and mapping effort. The first step at each site is the development of a Reference Model using a grid with the finest resolution available, followed by extensive testing against all available data to achieve the highest possible accuracy. The second step is development of the Standby Inundation Model (SIM), which is used as the forecast model. This is done through modification of the grid to optimize for speed, yet retain a level of accuracy that is appropriate for operational forecast and warning purposes.

The NCTR employs a suite of tsunami generation, propagation, and inundation codes developed by Titov and Gonzalez (1997). On local spatial scales, nonlinear shallow water (NSW) equations are solved numerically. Propagation on regional and transoceanic spatial scales requires equations that are expressed in spherical coordinates. Propagation solutions are obtained by a numerical technique that involves a mathematical transformation known as splitting (Titov, 1997). This suite of models has become known as the Method of Splitting Tsunamis (MOST) model.

Because life and property are at stake when tsunami warnings are issued, NOAA requires that models used in the Tsunami Forecasting System meet certain standards (Synolakis, et al., 2007). Among the requirements are:

- **Peer-reviewed publication.** A peer-reviewed article must be published that documents the scientific and numerical essentials of the model and includes at least one model comparison study using data from an historical tsunami.

NOAA Tsunami Forecast Modeling and Mapping

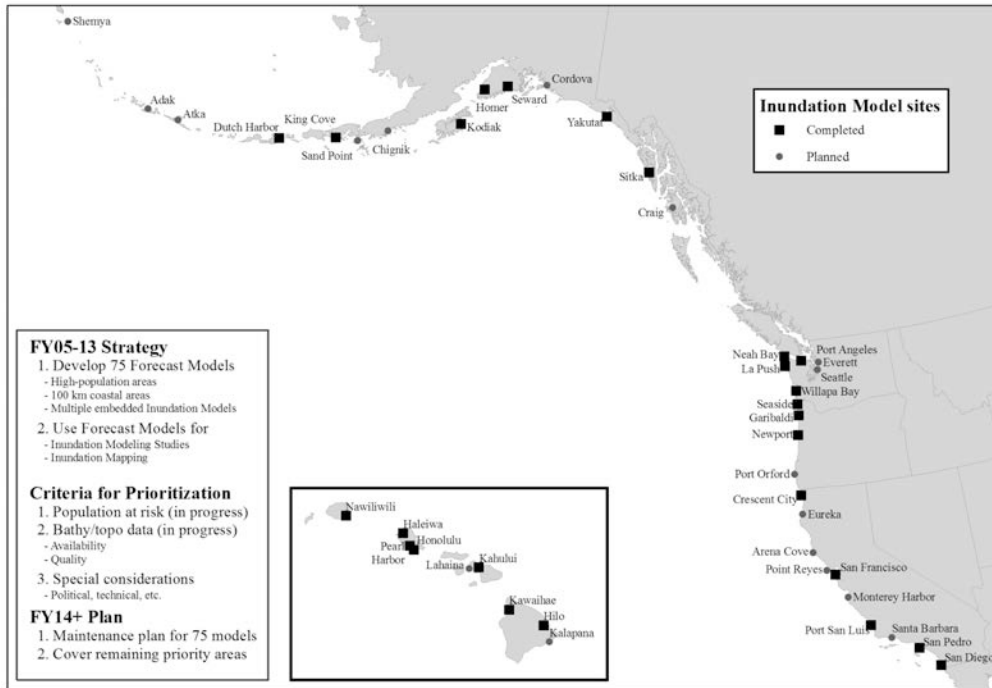

NOAA Tsunami Forecast Modeling and Mapping

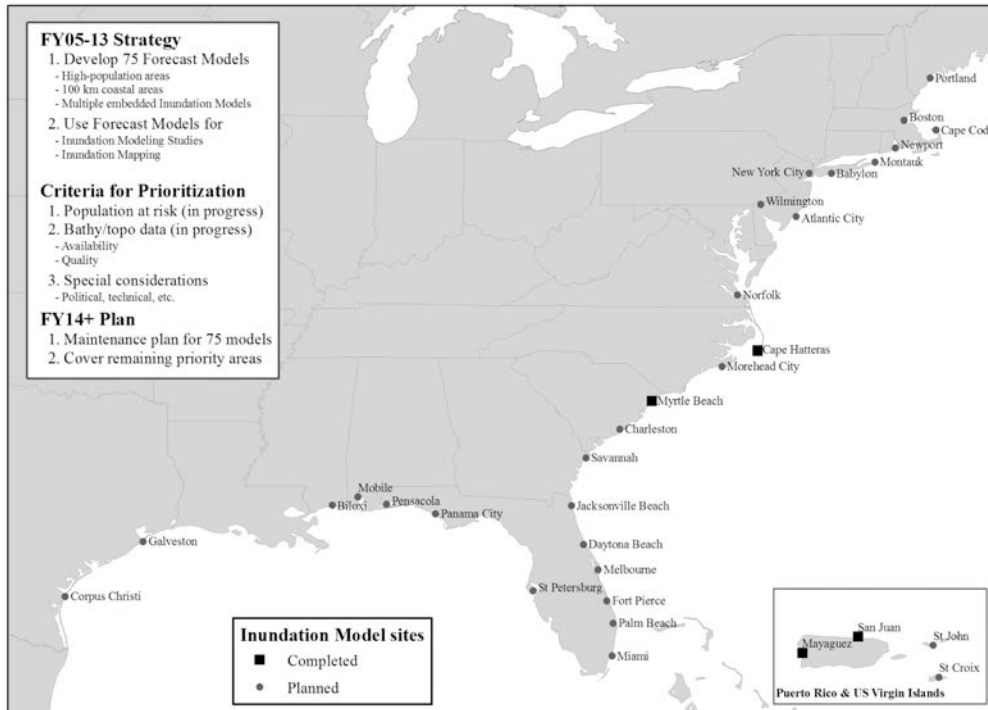

Figure 7-1 Coastal sites for site-specific tsunami inundation models for the Tsunami Forecasting System.

- **Benchmarking.** The model must be tested against other peer reviewed models in a benchmark workshop, and the results documented in a report. The National Science Foundation (NSF) has supported two

tsunami inundation modeling benchmark workshops (Yeh, et al., 1996; Liu, et al., 2006). The National Tsunami Hazard Mitigation Program supported another benchmarking workshop for which a peer-reviewed proceedings volume was published (NTHMP, 2012).

- **Operational assessment.** Important factors to be assessed include the model speed, accuracy, special operating environment needs, ease of use, and documentation.

Models meeting these requirements include the ADvanced CIRCulation (ADCIRC) model (Luettich and Westerink, 1991, 1995a, and 1995b; Myers and Baptista, 1995), hydrodynamic models of Kowalik and Murty (1993a, 1993b) as applied and field-checked against observed inundation in Alaska by Suleimani and others (2002a; 2002b), and the MOST model (Titov and Gonzalez, 1997). The MOST model has been extensively tested against laboratory experimental data and deep-ocean and inundation field measurements, and by successful modeling of benchmarking problems through participation in NSF-sponsored tsunami inundation model benchmark workshops.

Models validated in the most recent benchmark workshop include the Alaska Tsunami Forecast Model from the West Coast and Alaska Tsunami Warning Center, the Alaska Tsunami Model from the University of Alaska, SELFE from the Oregon Health Sciences Institute, FUNWAVE, from the Universities of Delaware and Rhode Island, THETIS from the Université de Pau et des Pays de l'Adour and University of Rhode Island, BOSZ and NEOWAVE from the University of Hawaii, TSUNAMI3D from University of Alaska and Texas A&M Galveston, GeoClaw from the University of Washington, and the MOST model from the Pacific Marine Environmental Laboratory. Most of these models are described elsewhere but the benchmark validation documentation is available in NTHMP (2012).

The primary function of these models is to provide NOAA Tsunami Warning Centers with real-time forecasts of coastal community inundation before and during an actual tsunami event. However, these site-specific inundation models can be applied to inundation modeling studies and the creation of inundation parameter databases, digital products, and maps specifically tailored to the design process.

7.3 Hazard Quantification for Design of Tsunami Vertical Evacuation Structures

The design tsunami event is termed the Maximum Considered Tsunami (MCT), taken as a probabilistic tsunami having a 2% chance of being

exceeded in a 50-year period, or a 2,475-year mean recurrence interval. The hazard level for tsunami design was selected to be consistent with the return period associated with the Maximum Considered Earthquake (MCE) concept historically used in seismic design. Once potential tsunami sources are identified, and the severity of the tsunami hazard is known, site-specific information on the extent of inundation, runup elevation, and flow velocities consistent with the Maximum Considered Tsunami are needed for design.

Tsunami inundation modeling is not routinely available commercially, but is performed by a number of organizations including government laboratories (U.S. Geological Survey, NOAA, Los Alamos National Laboratory), selected universities (Cornell University, Oregon Health and Science University, Texas A&M Galveston, University of Hawaii, University of Alaska Fairbanks, University of Rhode Island, University of Southern California, and University of Washington), and some consulting companies with coastal engineering expertise. An extensive bibliography of past tsunami-related research on modeling is available in Wiegel (2005, 2006a, 2006b, and 2008).

The NTHMP has suggested the minimum guidelines regarding tsunami inundation mapping and modeling.

- Models should meet benchmark standards (Synolakis, et al., 2007), as updated at the NTHMP model benchmarking workshop (NTHMP, 2012).
- Digital Elevation Models (DEMs) used to develop modeling grids near shore should be at a horizontal resolution of at least $\frac{1}{3}$ arc second, or about ten meters, but should not be smaller than the spacing of the source topographic data unless necessary to resolve important morphologic features.
- DEMs should be based on the most accurate digital elevation model available. Lidar is becoming increasingly available and can achieve vertical accuracy of less than 1 foot.
- Model runtime should be sufficient to capture the maximum inundation and drawdown of the tsunami simulation.
- The computational grid developed from the DEM should be fine enough that any topographic or bathymetric feature that has an impact on inundation should be represented by more than three grid cells.
- The computational grid domain should be large enough to capture all important tsunami wave dynamics.
- A vertical datum of Mean High Water should be used to capture tidal conditions or an alternative maximum flooding condition should be used in modeling for tsunamis in lakes.

The design tsunami event is termed the Maximum Considered Tsunami (MCT), taken as a probabilistic tsunami having a 2% chance of being exceeded in a 50-year period, or a 2,475-year mean recurrence level, selected to be consistent with the return period associated with the Maximum Considered Earthquake (MCE) concept historically used in seismic design.

It should be noted that the above recommendations do not include modeling for tsunamis induced by landslides, volcanoes, or meteorite impacts.

7.4 ASCE Tsunami Design Geodatabase

To facilitate design, ASCE/SEI 7-16, *Minimum Design Loads and Associated Criteria for Buildings and Other Structures* (ASCE, 2016), provides offshore tsunami amplitude, dominant waveform period, and Tsunami Design Zone (TDZ) maps for the coastlines of Washington, Oregon, California, and Hawaii, and most of the southern coastline of Alaska and the Aleutian Islands. This information is available in the ASCE Tsunami Design Geodatabase, Version 2016-1.0, in the *ASCE Tsunami Hazard Tool*, online at <https://asce7tsunami.online> (ASCE, 2017b).

The ASCE Tsunami Design Geodatabase provides design basis data for the following parameters:

- Extent of the Tsunami Design Zone (TDZ)
- Runup elevations
- Inundation depth reference points for overwashed peninsulas and/or islands
- Probabilistic subsidence maps
- Offshore tsunami amplitude and predominant period for probabilistic tsunami hazard analysis (PTHA)
- Disaggregated tsunami-genic seismic sources

Portions of the southern coastline of Alaska were not included in the database because of a lack of available bathymetry and topography of adequate resolution. Also, the northern and western Alaska coastlines were not included because they are not exposed to tsunamis generated by subduction zone earthquakes, and therefore lack adequate data to develop a probabilistic tsunami hazard analysis. For similar reasons, the Atlantic and Gulf coastlines and U.S. territories such as Puerto Rico, U.S. Virgin Islands, Guam, Northern Marianas and American Samoa were also not included.

An example of ASCE Tsunami Design Geodatabase interface, showing the 100-meter bathymetric line (offshore, in blue), run-up elevation points (red), extent of inundation, and the Tsunami Design Zone, is shown in Figure 7-2. Selecting any of the blue offshore points displays a figure showing the disaggregated tsunami sources, wave amplitude, predominant period, and exact latitude and longitude location of the offshore data point. Selecting any of the red run-up points provides the run-up elevation along with the exact latitude and longitude location of the data point.

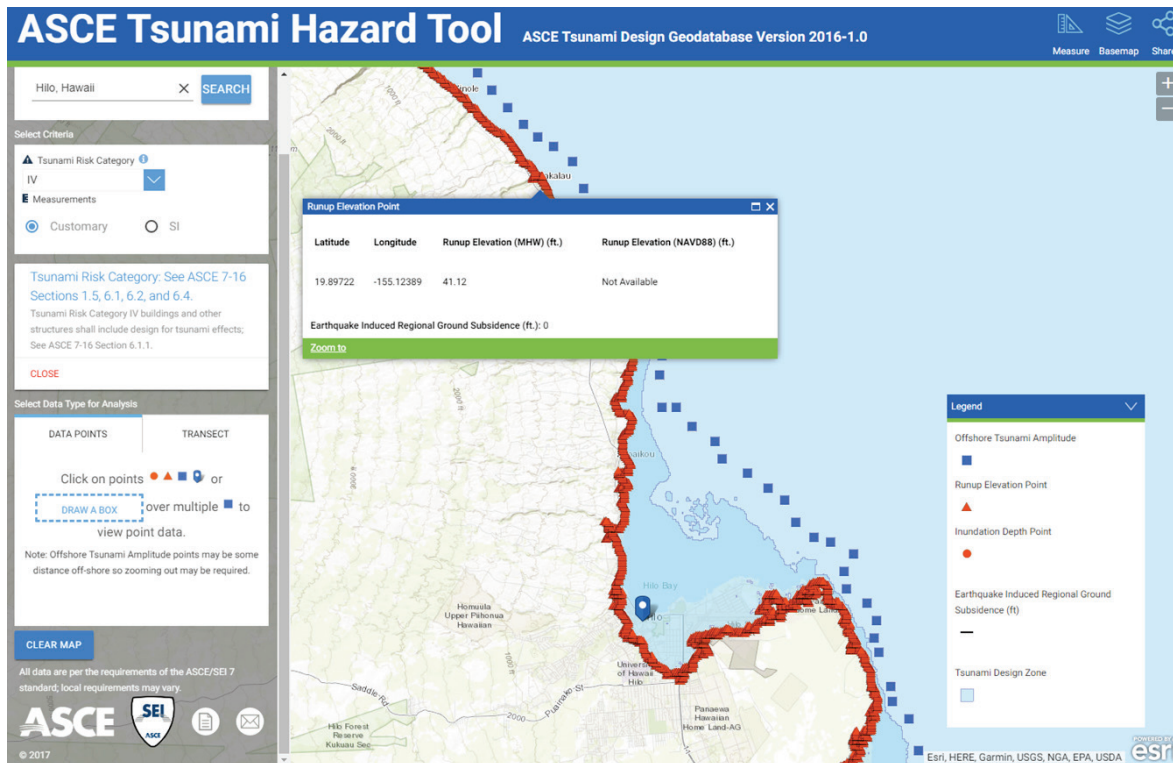

Figure 7-2 ASCE Tsunami Design Geodatabase interface, showing the extent of inundation, the Tsunami Design Zone, and run-up elevation points (ASCE, 2017).

7.4.1 Development of Maximum Considered Tsunami Design Parameters

Past reliance on historical tsunamis has failed to adequately predict the hazard level for design, so a probabilistic approach is now considered the best available method for estimating potential future tsunamis. The ASCE Tsunami Design Geodatabase is based on a probabilistic tsunami hazard analysis (PTHA) of all tsunami-genic seismic sources in the Pacific Basin for a Maximum Considered Tsunami (MCT) with a 2% probability of exceedance in 50 years, or a mean recurrence interval (MRI) of 2,475 years, represented by the offshore tsunami amplitude and characteristic period at 100-meter bathymetric depth.

Tsunami sources are fully integrated over seismic sources varying in size and recurrence rate. Uncertainties are included through the use of logic trees based on earthquake source predictions by the U.S. Geological Survey (USGS) and probability distribution functions based on inundation model comparisons with measured runup during past tsunamis. The results include uncertainties relating to a lack of understanding of the source mechanism (e.g., slip distribution and wave generation), and uncertainties relating to modeling of trans-oceanic wave propagation (Thio and Wei, 2017).

Local tsunamis can be generated by large landslides at or near the coast, and by underwater volcanic eruptions. Alaska has a history of coseismic landslides generating local tsunamis in fjords. For this reason, the design parameters for Alaska represent the composite hazard associated with local landslide-induced tsunamis as well as offshore-generated tsunamis.

To determine the extent of tsunami inundation along exposed coastlines, probabilistic offshore wave heights were used to generate onshore inundation modeling to determine the Tsunami Design Zone and runup elevations. Disaggregated sources were used to generate scenario tsunamis which were propagated towards the coastline of interest. The resulting offshore wave at 100-meter bathymetric depth was compared with ASCE/SEI 7-16 probabilistic tsunami hazard analysis 2,475-year wave amplitudes to ensure a good match, with no wave heights less than 80% of the offshore data points. The tsunami was then propagated inland using a 60-meter horizontal grid resolution Digital Elevation Model (DEM) to determine the inundation limit. All land seaward of the inundation limit is in the Tsunami Design Zone. Work was performed by researchers at the NOAA Pacific Marine Environmental Laboratory, in Seattle, Washington (Wei and Thio, 2017).

Local jurisdictions are encouraged to develop Tsunami Design Zone maps using higher resolution elevation data, following ASCE/SEI 7-16 probabilistic tsunami hazard analysis (PTHA) procedures. Locally developed maps, based on higher resolution topography, should be more accurate and could, therefore, be used in lieu of ASCE/SEI 7-16 maps in a State or local building code. With support from NTHMP, both California and Hawaii have developed higher resolution tsunami inundation maps that are currently being considered for adoption in future editions of ASCE/SEI 7. Other probabilistic-based NTHMP tsunami inundation maps, which have higher resolution, may also be used for this purpose.

7.4.2 Probabilistic Tsunami Hazard Analysis

Where design data are not available, probabilistic tsunami hazard analysis (PTHA) in accordance with ASCE/SEI 7-16 is required to develop design parameters. For site-specific tsunami hazard assessments, the Maximum Considered Tsunami should be developed using the tsunami-genic seismic events determined from a probabilistic hazard analysis following the procedures outlined in ASCE/SEI 7-16.

ASCE/SEI 7-16 requires that site-specific probabilistic tsunami hazard analysis be performed for all vertical evacuation refuge structures. The results of site-specific modeling must be compared with results obtained

ASCE/SEI 7-16 requires that site-specific probabilistic tsunami hazard analysis be performed for all vertical evacuation refuge structures. Results must be compared with the ASCE/SEI 7-16 Energy Grade Line Analysis to ensure that design values are not unconservatively low.

using the ASCE/SEI 7-16 Energy Grade Line Analysis, to avoid underestimation of the flow velocity due to errors in site-specific modeling. and to ensure that design values are not unconservatively low.

7.5 Recommendations for Improving Tsunami Hazard Assessment

Similar to design for other hazards, a desirable goal for tsunami-resistant design of vertical evacuation structures is to achieve a uniform level of safety across all communities subjected to tsunami risk. ASCE/SEI 7-16, *Minimum Design Loads and Associated Criteria for Buildings and Other Structures*, is based on achieving structural reliability performance goals using probabilistic definitions of all hazards. In seismic, wind, and tsunami design, the starting point is probabilistic mapping of earthquake, wind, and tsunami hazard. The hazard is further refined by considering local effects such as soil type for seismic design, topographic effects for wind design, and local bathymetry and topography for tsunami design.

Although probabilistic maps for tsunami hazard are more difficult for the public to interpret because they do not represent a recognizable tsunami scenario, they are a more reliable tool for design of tsunami-resistant structures. A probabilistic approach also provides a means to account for uncertainty in the tsunami source, open ocean propagation, and coastal inundation. Increases in the accuracy of probabilistic mapping could be achieved with improvement in understanding and modeling of the following aspects of tsunami hazard:

- Improved estimation of return period for large magnitude subduction zone earthquakes.
- Increased paleo-tsunami research into sand deposits from pre-historic tsunamis to significantly improve estimation of return period for tsunami-genic earthquakes.
- Better understanding of the potential slip distribution for subduction zone earthquakes, which can have a significant impact on tsunami magnitude.
- Improved nonlinear modeling of coastal inundation, including the effects of existing structures that are likely to survive the tsunami flow.
- Improved simulation of tsunami bore formation to enable design for increased loads induced by bore impact.

Chapter 8

Load Determination and Structural Design Criteria

In 2008, when the first edition of this report was published, there was very little guidance in U.S. structural design codes and standards on loads induced by tsunami inundation. Since then, use in conceptual design studies, ongoing research, and tsunami risk mitigation projects has advanced tsunami-resistant design to the point that consensus design provisions have been developed and adopted into ASCE/SEI 7-16, *Minimum Design Loads and Associated Criteria for Buildings and Other Structures* (ASCE, 2016), and by reference into the 2018 edition of the *International Building Code* (ICC, 2018).

This chapter summarizes the history and development of structural design criteria for tsunami load effects, introduces the ASCE/SEI 7-16 tsunami design provisions, highlights important ASCE/SEI 7-16 design requirements, and provides additional guidance and commentary for the design of vertical evacuation refuge structures.

This chapter is intended as a supplement to ASCE/SEI 7-16. It summarizes and discusses structural design criteria, but is not a substitute for the design provisions contained within the standard. Readers are cautioned that design of tsunami-resistant structures must follow all applicable design requirements as they are written in the International Building Code and the ASCE/SEI 7-16 reference design standard.

8.1 Previously Available Structural Design Criteria

Prior to development of explicit expressions for tsunami load effects, established design information was focused primarily on loads due to rising water and wave action associated with riverine flooding and storm surge. It was presumed that available flood design standards could be adapted for use in tsunami design.

This section summarizes previously available guidelines, codes, and standards, and highlights how they differ from conditions in a tsunami.

8.1.1 Guidelines, Codes, and Standards

ASCE/SEI Standard 24-14. ASCE/SEI 24-14, *Flood Resistant Design and Construction* (ASCE, 2014a) was formulated for compliance with FEMA National Flood Insurance Program (NFIP) floodplain management requirements. It provides minimum requirements for flood-resistant design and construction of structures located in flood-hazard areas including high-risk flood-hazard areas, coastal high-hazard areas, and coastal A zones.

In ASCE/SEI 24-14, design for coastal flooding includes proportioning structures to resist the anticipated flood depths, pressures, velocities, impact, uplift forces, and other factors associated with flooding. Habitable space in buildings must be elevated above the regulatory flood elevation by such means as posts, piles, piers, or shear walls parallel to the expected direction of flow, and spaces below the design flood elevation must be free from obstruction. Walls and partitions in coastal high-hazard areas are required to break away so as not to induce excessive loads on the structural frame. Effects of long-term erosion, storm-induced erosion, and local scour are to be included in the design of foundations in coastal high-hazard areas, and foundation embedment must be far enough below the depth of potential scour to provide adequate support for the structure.

ASCE/SEI Standard 7-10. ASCE/SEI 7-10, *Minimum Design Loads for Buildings and Other Structures* (ASCE, 2010) provides expressions for forces associated with flood and wave loads on specific types of structural components including breakaway walls. Chapter 5 “Flood Loads” refers to ASCE/SEI 24, and covers important definitions related to flooding and coastal high-hazard areas, tides, storm surges, and breaking waves.

FEMA P-55 Coastal Construction Manual. The FEMA P-55, *Coastal Construction Manual, Fourth Edition* (FEMA, 2011) was developed to provide design and construction guidance for low-rise (less than three stories), one- and two-family residential structures built in coastal areas throughout the United States. It mentions seismic hazards for coastal structures, and contains expressions for flood loads, wave loads, and load combinations for specific types of structural components.

The *Coastal Construction Manual* provides general information on tsunami hazard, but includes significant limitations with regard to designing for tsunami load effects, stating that, “This Manual does not provide guidance for estimating flood velocities during tsunamis,” and that, “Tsunami loads on residential buildings may be calculated in the same fashion as other flood loads; the physical processes are the same, but the scale of the flood loads is substantially different in that the wavelengths and runup elevations of

tsunamis are much greater than those of waves caused by tropical or extratropical cyclones.” The *Coastal Construction Manual* concludes that it is generally not feasible or practical to design normal structures to withstand tsunami loading, although it should be noted that the context for this conclusion is conventional light-frame residential construction.

City and County of Honolulu Building Code. The *City and County of Honolulu Building Code* (City and County of Honolulu, 2007), Chapter 16, Article 11, provides specific guidance for structural design of buildings and structures subject to tsunamis. Loading requirements in this section are based on *Design and Construction Standards for Residential Construction in Tsunami-Prone Areas in Hawaii* (Dames & Moore, 1980), specifically *Appendix A, Proposed Building Code Amendments*. Drag forces are based on a non-bore velocity of flow in feet/second roughly estimated as equal in magnitude to the depth in feet of water at the structure (which is inconsistent with a Froude number assumption that would relate to the square root of the depth). The report states that, “The adequacy of this approach... has not been satisfactorily examined.” Prescriptive forces on walls, however, are based on a bore flow velocity of $2\sqrt{gh}$. Rough estimates are also given for anticipated scour around piles and piers, based on distance from the shoreline and soil type at the building site, although the basis for these scour values is not documented. Unchanged since they were first adopted in 1984, these provisions are largely archaic and useful only for historical context.

International Building Code. The *International Building Code* (ICC, 2015), Section 1612 “Flood Loads,” Section 1804 “Excavation, Grading and Fill,” and Appendix G “Flood Resistant Construction,” provides information on flood design and flood-resistant construction, including reference to ASCE/SEI 24. Appendix M “Tsunami Generated Flood Hazard,” provides tsunami regulatory criteria for communities that have a recognized tsunami hazard, have developed and adopted a map of their Tsunami Hazard Zone, and are focused on keeping critical and high-risk structures out of the tsunami inundation zone. However, vertical evacuation refuge structures would be permitted within the Tsunami Hazard Zone if designed in accordance with FEMA P-646, or if designed to resist the hydrostatic, hydrodynamic, debris accumulation, impact, and scour effects associated with the Maximum Considered Tsunami without collapse. Appendix G and Appendix M are non-mandatory appendices unless adopted by a local authority having jurisdiction.

8.1.2 Limitations in Previously Available Flood Design Criteria Relative to Tsunami Loading

Although many of the hydrostatic and hydrodynamic loading expressions in previously available guidelines, codes, and standards are well-established for riverine and storm surge flooding, there are significant differences associated with tsunami inundation.

Although many of the hydrostatic and hydrodynamic loading expressions in previously available guidelines, codes, and standards are well-established for riverine and storm surge flooding, there are significant differences associated with tsunami inundation:

- A major difference between tsunamis and other coastal flooding is increased flow velocity for tsunamis, which results in significant increases in velocity-related loads on structural components. In a typical tsunami, the water surface fluctuates near the shore with an amplitude that may range from several meters to tens of meters over a period of a few minutes to an hour.
- Application of previously available loading expressions for tsunami loading required an estimate of the tsunami inundation depth and velocity, neither of which was provided with much accuracy prior to recent nationally coordinated tsunami hazard assessment programs.
- Although impact forces from floating debris (e.g., logs) have been previously considered, more significant forms of debris, such as barges, fishing boats, and shipping containers need to be considered for tsunamis. The size, mass, and stiffness of this type of debris was not considered in previously available expressions, and no accommodation was made for potential damming if the debris was blocked by structural components.
- No consideration has been given to upward loads on the underside of components in buildings that are submerged by tsunami inundation. Vertical hydrodynamic loads, different from buoyancy effects, have been previously considered by the offshore industry in design of platforms and structural members that can be submerged by large waves.
- Although the impacts of scour have been previously considered, little guidance (other than rough estimates) has been given as to the potential extent of scour. There are two primary mechanisms for scour that occur in a tsunami event. Shear-induced scour consists of soil transport due to flow velocity, and is similar to that observed in storm surge flooding. Scour induced by pore pressure softening results from rapid drawdown as the water recedes from the shoreline. Without sufficient time to dissipate, pore pressure causes softening of the soil, which results in substantially greater scour during tsunami inundation.

8.2 ASCE/SEI 7-16 Tsunami Loads and Effects

ASCE/SEI 7-16, Chapter 6 “Tsunami Loads and Effects” provides a unified set of analysis and design methodologies that are consistent with probabilistic hazard analysis, tsunami physics, engineering hydraulics, and structural reliability analysis. It represents the current state-of-the-art for design of buildings and other structures to resist tsunamis.

ASCE/SEI 7-16, Chapter 6 “Tsunami Loads and Effects,” represents the current state-of-the-art for design of buildings and other structures to resist tsunamis.

Development of the provisions was based on information contained in the second edition of FEMA P-646 (FEMA, 2012), recent tsunami performance-based design research projects initiated after the 2004 Indian Ocean and 2011 Tohoku tsunamis, observations from past tsunami events, and current consensus engineering opinion.

Structural design procedures target a high reliability of safety based on a Maximum Considered Tsunami (MCT) event, taken as a probabilistic tsunami having a 2% chance of being exceeded in a 50-year period, or a 2,475-year mean recurrence interval.

Structural design procedures target a high reliability of safety based on a Maximum Considered Tsunami (MCT) event, taken as a probabilistic tsunami having a 2% chance of being exceeded in a 50-year period, or a 2,475-year mean recurrence interval.

Tsunami design parameters are provided online in the ASCE Tsunami Design Geodatabase, Version 2016-1.0 (ASCE, 2017b), applicable to coastal areas in Alaska, California, Hawaii, Oregon, and Washington, for the design of critical and essential facilities located in mapped Tsunami Design Zones. Although currently limited to where data are available, ASCE/SEI 7-16 tsunami provisions can be applied to any coastal community in which a 2,475-year probabilistic tsunami hazard analysis has been performed for the specific location in accordance with ASCE/SEI 7-16 procedures.

8.2.1 Tsunami Risk Categories

For the purpose of tsunami design, buildings and other structures are assigned to Tsunami Risk Categories, which are similar to, but modified from, Risk Categories used in the determination of loads for other hazards. Modifications include permissible exceptions to the types of structures that are included in each Risk Category. Tsunami design is required for:

- all structures designated as Tsunami Risk Category IV, which includes tsunami vertical evacuation refuge structures;
- Tsunami Risk Category III structures, where inundation depths exceed 3 feet (0.914 m); and
- Tsunami Risk Category II structures, only where designated by local statute.

Based on Tsunami Risk Categories, tsunami importance factors, I_{tsu} , are applied to hydrodynamic and impact loads.

Although Tsunami Risk Category II buildings and structures are largely exempt from tsunami design requirements, local jurisdictions in regions of high tsunami risk areas are encouraged to require tsunami-resistant design for taller buildings in the tsunami inundation zone. Past experience has shown that complete evacuation of the population is never fully realized, and there is ample evidence that taller structures can provide effective secondary refuge when evacuation to primary areas of refuge is not possible or practically achievable for an entire population.

8.2.2 Determination of Design Inundation Depth and Flow Velocity

ASCE/SEI 7-16 specifies two procedures for determination of design inundation depth and flow velocity: (1) Energy Grade Line Analysis; and (2) Probabilistic Tsunami Hazard Analysis (PTHA). For Tsunami Risk Category IV structures, Probabilistic Tsunami Hazard Analysis is required, but results must be compared with results obtained using the Energy Grade Line Analysis to avoid potential underestimation of flow velocity due to errors in site-specific modeling. For Tsunami Risk Category II and III structures, an Energy Grade Line Analysis shall be performed, and a Probabilistic Tsunami Hazard Analysis is permitted. Where data are available, runup elevations for the Energy Grade Line Analysis can be obtained from the ASCE Tsunami Design Geodatabase.

8.2.3 Structural Design Procedures

Tsunami loads are considered sustained actions, and components are protected from strength degradation under sustained forces.

Except in the case of debris impact, tsunami loads are considered sustained actions, and components are protected from strength degradation under sustained forces. ASCE/SEI 7-16 specifies three structural design procedures for tsunami load effects:

Linear-Static Analysis. Internal forces and system displacements are determined by a linearly elastic, static analysis. In this procedure, the design strengths of components and connections are checked against Maximum Considered Tsunami loads and effects. In computing the design strength, material resistance factors, ϕ , are as prescribed in material design standards.

Alternative Performance-Based Analysis is permitted, based on procedures contained in ASCE/SEI 41-13, *Seismic Evaluation and Retrofit of Existing Buildings*.

Alternative Performance-Based Analysis. Internal forces and system displacements are determined by linear or nonlinear static analysis based on procedures contained in ASCE/SEI 41-13, *Seismic Evaluation and Retrofit of Existing Buildings* (ASCE, 2014b). In a linear static analysis, structures are modeled using an effective secant stiffness. In a nonlinear static analysis, structures are modeled using component nonlinear load-deformation curves, and are subjected to monotonically increasing loads until Maximum Considered Tsunami loads and effects are reached.

Component demands are classified as force-sustained actions or ductility-governed actions. Strength degradation is not permitted under force-sustained actions, and component demands are checked against specified design strengths. For ductility-governed actions, component demands are checked against expected strengths determined in accordance with ASCE/SEI 41-13.

Alternative Progressive Collapse. Where acceptability criteria are exceeded, or in the case of extraordinary debris impact loads, use of recognized progressive collapse procedures are permitted for checking the residual capacity of the structure assuming selected components have failed.

Additional explanation of ASCE/SEI 7-16 tsunami design provisions, along with detailed example applications on prototypical buildings, is provided in Chock (2016) and Robertson (2018).

8.3 Performance Objectives

Although performance objectives for rare loading can vary, acceptable structural performance generally follows a trend corresponding to:

- little or no damage for small, more frequently occurring events;
- moderate damage for medium-size, less frequent events; and
- significant damage, but no collapse for very large, rare events.

Similar to Tsunami Risk Categories, Risk Category is a categorization used in building codes to determine design loads based on the risk associated with unacceptable performance. In general, Risk Categories are defined as follows:

- Risk Category I – buildings and other structures that represent a low risk to human life;
- Risk Category II – standard occupancy structures;
- Risk Category III – hazardous or otherwise important facilities; and
- Risk Category IV – essential facilities.

Performance-based design procedures are intended to explicitly evaluate and predict performance, rather than relying on presumed performance associated with prescriptive design rules. The current standard-of-practice for performance-based seismic design is contained in ASCE/SEI 41-17, *Seismic Evaluation and Retrofit of Existing Buildings* (ASCE, 2017a), which defines discrete performance levels intended to connote the expected condition of the building: Collapse Prevention, Life Safety, Immediate Occupancy, and

Operational. Seismic performance objectives are defined by linking one of these performance levels to an earthquake hazard level that is related to a mean recurrence interval (return period) and intensity of ground shaking. A matrix of performance objectives is shown in Figure 8-1.

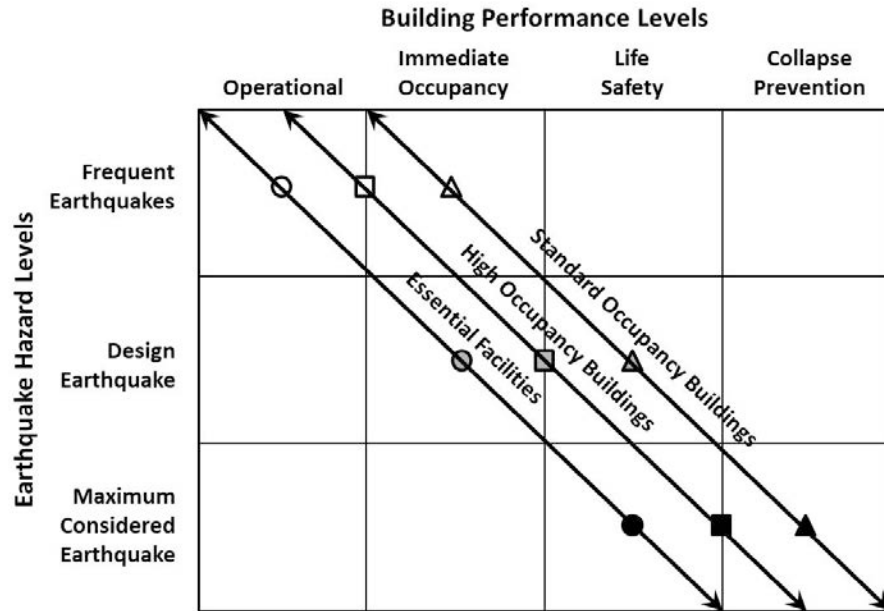

Figure 8-1 Seismic performance objectives linking building performance levels to earthquake hazard levels (adapted from ASCE/SEI 7-16, 2016).

Future guidance on performance-based seismic design can be found in FEMA P-58, *Seismic Performance Assessment of Buildings, Methodology and Implementation* (FEMA, 2018), which is a probabilistic methodology that explicitly estimates losses in terms of repair costs, repair time, casualties, unsafe placarding, and environmental losses associated with earthquake damage.

8.3.1 Tsunami Performance Objectives

In determining performance objectives, the most difficult decision is how rare (or intense) the design event should be. For tsunami design, the Maximum Considered Tsunami (MCT) having a 2% chance of being exceeded in a 50-year period, or a 2,475-year mean recurrence interval, was selected for consistency with the return period associated with the Maximum Considered Earthquake (MCE) concept historically used in seismic design.

Figure 8-2 shows the expected performance levels for each tsunami risk category, given the Maximum Considered Tsunami hazard level, based on information provided in the commentary to ASCE/SEI 7-16. Although

vertical evacuation structures are included in Tsunami Risk Category IV, enhanced design requirements specific to vertical evacuation structures are intended to achieve a higher performance level (e.g., Immediate Occupancy) when subjected to the Maximum Considered Tsunami.

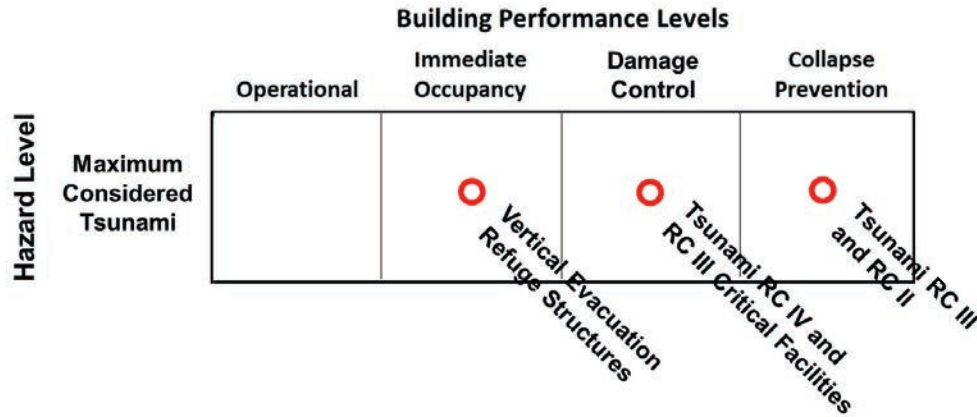

Figure 8-2 Expected performance levels for each Tsunami Risk Category, given the Maximum Considered Tsunami hazard level.

A reliability analysis performed by Chock, et al. (2016) showed that, based on failure of an exterior column, a tsunami vertical evacuation refuge structure designed in accordance with ASCE/SEI 7-16 will have less than a 1% probability of failure when subjected to the Maximum Considered Tsunami.

The same building subjected to a Maximum Considered Earthquake will have a 2.5% probability of failure (ASCE, 2016). Therefore, if a tsunami vertical evacuation refuge structure survives a near-source earthquake, it will also have a high probability of surviving a subsequent tsunami.

8.4 Earthquake Loads

The recommended basis for seismic design of vertical evacuation structures is the *International Building Code*, which references ASCE/SEI 7-16 for seismic design requirements. The performance objective for vertical evacuation refuge structures subjected to seismic hazards should be consistent with Risk Category IV essential facilities, such as hospitals, police and fire stations, and emergency operation centers.

The recommended basis for seismic evaluation and retrofit of existing buildings that are being considered for use as vertical evacuation refuge structures is ASCE/SEI 41-17.

8.4.1 Near-Source-Generated Tsunamis

A vertical evacuation structure located in a region susceptible to near-source-generated tsunamis is likely to experience strong ground shaking immediately prior to the tsunami. In the case of vertical evacuation refuge structures subjected to an earthquake associated with a near-source-generated tsunami, enhanced seismic performance is necessary to ensure that the structure is usable as a tsunami refuge following the seismic event.

To obtain a higher level of confidence in achieving enhanced seismic performance, the design developed by prescriptive seismic provisions can be evaluated using current performance-based seismic design techniques and verification analyses. Utilizing the approach in ASCE/SEI 41-17, the performance objective for essential facilities would be Immediate Occupancy performance for the Design Earthquake and Life Safety performance for the Maximum Considered Earthquake. Explicit estimation of earthquake damage and consequences could also be performed using FEMA P-58.

It is expected that sufficient reserve capacity will be provided in the structure to resist the subsequent tsunami loading effects. The reserve capacity of the structure, which will be some fraction of the original, needs to be evaluated. It is recommended that the condition of the structure after the Design Earthquake be used to determine the adequacy for tsunami loading. If inadequate, the resulting design would then need to be modified as necessary to address tsunami load effects. For areas that are subject to near-source-generated tsunamis, this sequential loading condition will clearly control the design of the structure. To help ensure adequate strength and ductility in the structure for resisting tsunami load effects, Seismic Design Category D, as defined in ASCE/SEI 7-16, should be assigned to the structure, as a minimum.

A properly designed essential facility is also expected to have improved performance of nonstructural components including ceilings, walls, light fixtures, fire sprinklers, and other building systems. For evacuees to feel comfortable entering a vertical evacuation structure following an earthquake, and remaining in the structure during potential aftershocks, it is important that visible damage to both structural and nonstructural components be limited. Particular attention should be focused on nonstructural components in the stairwells, ramps, and entrances that provide access and vertical circulation within the structure. FEMA E-74, *Reducing the Risks of Nonstructural Earthquake Damage* provides more guidance on reducing the risk associated with nonstructural components (FEMA, 2012a).

8.4.2 Far-Source-Generated Tsunamis

Although a vertical evacuation structure located in a region susceptible to far-source-generated tsunamis is not likely to experience strong ground shaking prior to the tsunami, seismic design must be independently considered based on the seismic hazard that is present at the site. Even in regions of low seismicity, it is recommended that Seismic Design Category D be assigned to the structure, as a minimum, to help ensure adequate continuity, strength, and ductility in the structural system for resisting tsunami loads and effects.

8.5 Wind Loads

The recommended basis for wind design of a vertical evacuation structure is the *International Building Code*, which references ASCE/SEI 7-16 for the majority of its wind design requirements. In many locations affected by tsunami risk, earthquake loading will likely govern over wind loading, but this is not necessarily true for all regions.

At locations where wind loading controls the design, the use of special seismic detailing for structural components should be considered. It is recommended that Seismic Design Category D be assigned to the structure, even where wind loading controls the design, to help ensure adequate strength and ductility in the structural system for resisting tsunami loads and effects.

8.6 Tsunami Loads

ASCE/SEI 7-16 Chapter 6 provides design requirements for numerous tsunami loads including: hydrostatic forces; buoyant forces; hydrodynamic forces; impulsive forces; debris impact forces; debris damming effects; uplift forces; and additional gravity loads from retained water on elevated floors.

Wave-breaking forces are not considered in the design of vertical evacuation structures. The term ‘wave-breaking’ is defined here as a plunging-type breaker in which the entire wave front overturns. When waves break in a plunging mode, the wave front becomes almost vertical, generating an extremely high pressure over a short duration. In general, tsunamis break offshore, and vertical evacuation structures should be located some distance inland from the shoreline. Once a tsunami wave has broken, it can be considered as a bore because of its very long wavelength.

Wave-breaking forces could be critical for vertical evacuation refuge structures located in the wave-breaking zone, which is beyond the scope of this document. If it is determined that a structure must be located in the

Tsunami load effects include:

- hydrostatic forces;
- buoyant forces;
- hydrodynamic forces;
- impulsive forces;
- debris impact forces;
- debris damming effects;
- uplift forces; and
- additional gravity loads from retained water on elevated floors.

wave-breaking zone, ASCE/SEI 7-16, Chapter 5 “Flood Loads” and the *Coastal Engineering Manual*, EM 1110-2-1100, (USACE, 2011) should be consulted for guidance on wave-breaking forces.

8.6.1 Key Assumptions for Estimating Tsunami Loads and Effects

ASCE/SEI 7-16 tsunami loads are determined using the following key assumptions:

- Tsunami flows consist of a mixture of sediment and seawater. Most suspended sediment transport flows do not exceed 7% sediment concentration. Based on an assumption of vertically averaged sediment-volume concentration of 7% in seawater, the fluid density of tsunami flow is taken as 1.1 times the density of seawater, or $\rho_s = 1,128 \text{ kg/m}^3 = 2.2 \text{ slugs/ft}^3$.
- Tsunami flow depths vary significantly depending on the three-dimensional bathymetry and topography at the location under consideration. Figure 8-3 shows three possible scenarios where topography could affect the relationship between maximum tsunami elevation, T_E , at a particular location and the ultimate inland runup elevation, R . Site-specific PTHA numerical simulations of tsunami inundation are required for all Tsunami Risk Category IV structures, including vertical evacuation refuge structures. Results of this modeling will provide complete time histories of the flow depth, velocity, and momentum flux during the tsunami.
- There is significant variability in local tsunami runup elevations, based on local bathymetry and topographic effects, and uncertainty in numerical simulations of tsunami inundation. For vertical evacuation structures, ASCE/SEI 7-16 requires that the design runup elevation be taken as 1.3 times the predicted maximum runup elevation, R , obtained from site-specific tsunami inundation analysis to envelope the potential variability in estimates of inundation modeling. The inundation elevation above sea level from the runup point back towards the shoreline would then be scaled by the same factor, as shown by the dashed lines in Figure 8-3. Figure 8-4 shows a typical numerical prediction (Yamazaki et al., 2011) made for the 2009 Samoa Tsunami, which demonstrates that the 1.3 factor for uncertainty is realistic.

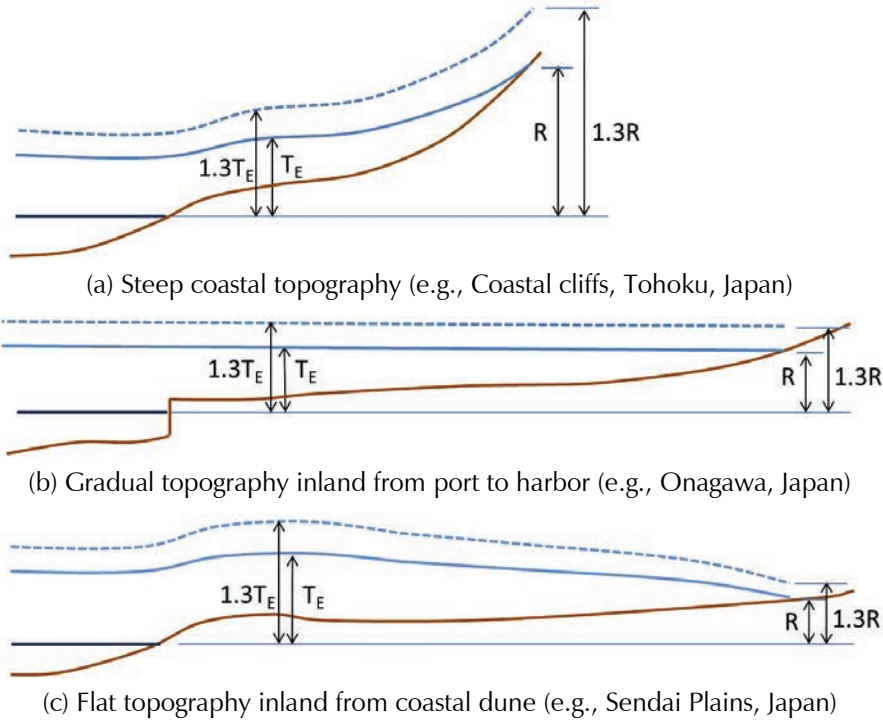

Figure 8-3 Three types of coastal inundation where the tsunami elevation (T_E) at a site of interest could be less than, equal to, or greater than the ultimate inland runup elevation (R). Note that the refuge elevation is based on $1.3T_E$, where T_E is the elevation above the sea level datum, not the flow depth at the site.

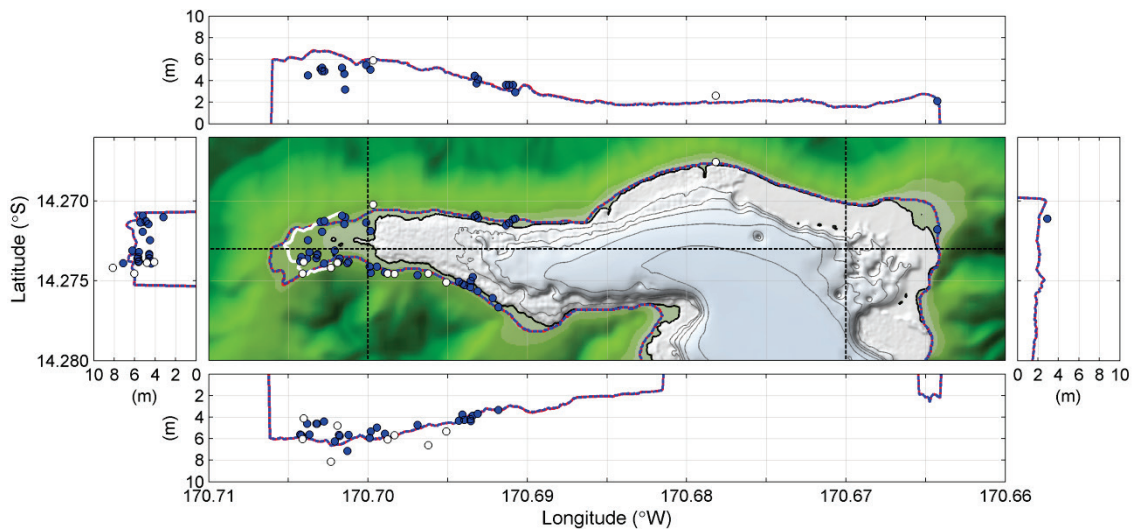

Figure 8-4 Comparison between numerical modeling (blue line) and field measurement of run-up (white dots) and flow elevations (blue dots) at Pago Pago Harbor, American Samoa (Yamazaki et al, 2011).

8.6.2 Hydrostatic Loads

Hydrostatic forces occur when standing or slowly moving water encounters a structure or structural component. This force always acts perpendicular to the surface of the component of interest, caused by an imbalance of pressure due to differential water depth on opposite sides of a structure or component.

Hydrostatic and buoyant forces must be computed when the ground floor of a building is watertight, or is sufficiently insulated and airtight to prevent or delay the intrusion of water. In this situation, the hydrostatic force should be evaluated for individual wall panels.

Hydrostatic forces also develop due to residual water surcharge loading on floors and walls when water is retained during drawdown. In addition, ASCE/SEI 7-16 requires consideration of hydrostatic surcharge pressure on foundations (not illustrated here).

8.6.2.1 Unbalanced Lateral Hydrostatic Force

ASCE/SEI 7-16 provides the design equation and requirements for unbalanced lateral hydrostatic forces in Section 6.9.2. Figure 8-5 illustrates the resulting pressure distribution and location of resultant hydrostatic force, F_h , on a typical wall element, where p_c is the hydrostatic pressure and h_{max} is the maximum water height above the base of the wall at the structure location. The moment about the base of the wall can be evaluated using the line of action of the hydrostatic force resultant.

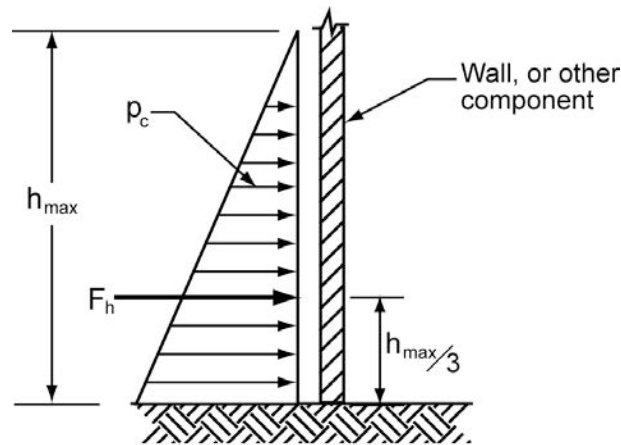

Figure 8-5 Hydrostatic pressure distribution and location of resultant hydrostatic force, F_h .

Hydrostatic forces are usually important for long structures such as sea walls and dikes, or for evaluation of an individual wall panel where the water level on one side differs substantially from the water level on the other side. ASCE/SEI 7-16 requires that hydrostatic forces be considered for structural

walls longer than 30 feet, with openings less than 10 percent of the wall area. Hydrostatic forces must also be considered for two- and three-sided structural wall configurations. Hydrostatic lateral forces may not be relevant to a structure with a finite (i.e., relatively short) width, around which the water can quickly flow and fill in on all sides.

8.6.2.2 Buoyancy

Buoyant hydrostatic forces will act vertically through the centroid of the displaced volume on a structure or structural component subjected to partial or total submergence. The total buoyant force equals the weight of water displaced. Buoyant forces on components must be resisted by the weight of the component and any opposing forces resisting flotation. Buoyant forces are a concern for structures that have little resistance to upward forces (e.g., light wood frame buildings, basements, empty tanks located above or below ground, swimming pools, components designed considering only gravity loads).

Buoyant forces, F_b , on an overall building are shown in Figure 8-6, where h_{max} is the maximum inundation depth at the site. If there is insufficient building weight to resist buoyant forces, tension piles may be used to increase the resistance to flotation, but reduction in pile side friction due to anticipated scour around the tops of the piles must be considered.

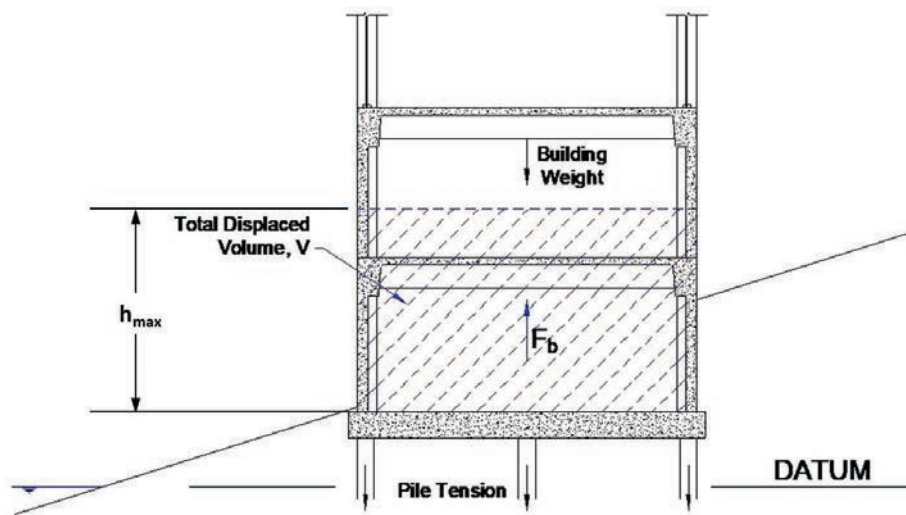

Figure 8-6 Buoyant forces, F_b , on an overall building with watertight lower levels.

ASCE/SEI 7-16 requires that buoyancy be checked for all watertight or sealed enclosures within the building. It also requires that buoyancy be considered for all buildings assuming that the water level has reached the lesser of one story or the height of the top of the first story windows, but not

exceeding the maximum inundation depth. Open structures with no walls at the first floor level, or with specially designed tsunami breakaway walls, are exempt from this buoyancy check. Also exempt are structures in which the soil properties or foundation and structural design prevent buildup of hydrostatic pressurization on the underside of the foundation and lowest structural slab. In such cases, there will be no buoyancy of the overall structure.

One relatively simple method to prevent overall building uplift due to buoyancy is to design the ground floor slab as a nonstructural slab-on-grade, with isolation joints between the slab and the pile caps and grade beams. Hydrostatic pressurization below the slab may result in uplift and failure of the slab-on-grade, but will not lift the rest of the building.

If the foundation level slab is a structural slab connected to the pile caps and grade beams, then the total uplift force due to buoyancy must be resisted by the dead weight of the building and any tensile capacity of the piled foundations. The presence of scour at the upper portion of the piles will reduce their available tensile capacity.

Load Case 1 in ASCE/SEI 7-16 requires that the structural system be evaluated for buoyancy effects along with hydrodynamic drag forces at the flow level corresponding to the buoyancy check.

8.6.3 Hydrodynamic Loads

When water flows around a structure, hydrodynamic forces are applied to the structure as a whole and to individual structural components. These forces are induced by the flow of water moving at moderate to high velocity, and are a function of fluid density, flow velocity and structure geometry. Also known as drag forces, they are a combination of the lateral forces caused by the pressure forces from the moving mass of water and the friction forces generated as the water flows around the structure or component.

ASCE/SEI 7-16 requires that hydrodynamic drag forces be evaluated for the entire building structure and for each individual structural element (column, beam, wall, etc.) below the flow depth. The effect of floating debris that accumulates against the exterior of a building, referred to as debris damming, is included in the evaluation of the degree of closure of the overall building and the tributary width for individual structural components.

Hydrodynamic drag forces, F_d , are shown in Figure 8-7, where h_{max} is the maximum water height above the base of the structure or component. Because flow velocity is approximately uniform through the flow depth, the

hydrodynamic pressure is distributed uniformly along the length of the structure or component, and the resultant hydrodynamic force, F_d , is applied at the centroid of the wetted surface.

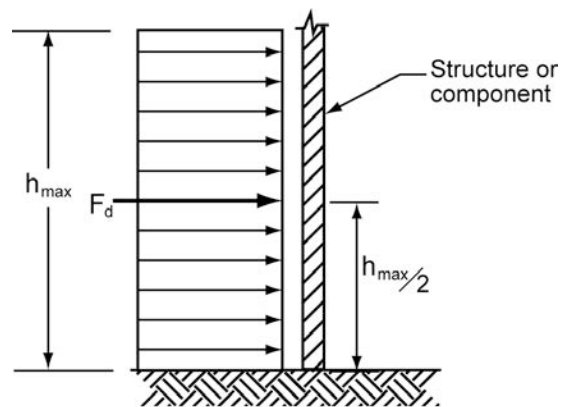

Figure 8-7 Hydrodynamic force distribution and location of resultant hydrodynamic force, F_d .

8.6.4 Impulsive Forces

Impulsive forces are caused by the leading edge of a surge of water impacting a structure. Ramsden (1993) performed comprehensive experiments on impulsive forces on solid walls. Laboratory data show no significant initial impact force (impulse force) in dry-bed surges, but an “overshoot” in force was observed in bores that occur when the site is initially flooded. The maximum overshoot is approximately 1.5 times the subsequent hydrodynamic force. This result was confirmed by the independent laboratory data for conditions where the structural component width exceeded three times the bore flow depth. It was also confirmed by large scale bore tests on a solid wall element by Robertson, et al. (2013).

ASCE/SEI 7-16 requires that bore impulsive loading be considered at locations likely to experience bores, and only for structural elements of width greater than 3 times the flow depth. The impulsive force is taken as 1.5 times the hydrodynamic force for the same element, and acts on members at the leading edge of the tsunami bore.

8.6.5 Debris Impact Forces

The impact force from waterborne debris (e.g., floating driftwood, lumber, shipping containers, automobiles, boats) can cause significant building damage. ASCE/SEI 7-16 provides design loading for impacts due to timber logs, automobiles, shipping containers and rolling boulders. These provisions are based on the following debris impact research.

- Piran Aghl, et al. (2014) performed full-scale tests using timber logs and standard 20-foot steel shipping containers to determine the maximum impact force during a longitudinal strike with a rigid body. The results of this experimental program show that the impact remains essentially elastic until crushing of the end of the timber log or buckling/yielding of the longitudinal elements of the shipping container. Based on the theory of elastic impact, confirmed by the full-scale tests, Riggs, et al. (2014) derived impact force and duration equations that have been incorporated into ASCE/SEI 7-16. The maximum design impact forces are defined by the crushing strength of the log and buckling/yielding strength of the shipping container.
- Piran Aghl et al. (2015) demonstrated that the contents of the shipping container do not affect the impact force, unless they are rigidly attached to the structural frame of the container to prevent sliding during impact. However, shipping container contents do increase the duration of impact.
- Ko, et al. (2014) performed experiments in a large wave flume using 1/5th scale shipping container models. They concluded that for longitudinal shipping container strikes, the effect of the fluid is secondary, and can be neglected for design purposes. ASCE/SEI 7-16 therefore ignores the added mass effect, but includes an orientation factor based on test results by Haehnel and Daly (2002).

Impact forces, F_i , are shown in Figure 8-8, where W is the weight of the debris, d is the draft depth, and u_{max} is the maximum flow velocity carrying the debris at the site. Impact forces, F_i , are assumed to act locally on a single exterior structural component at any elevation below the maximum flow depth. The probability of two or more simultaneous debris strikes is assumed to be low enough that it can be ignored, and debris impact forces are assumed to act independently of hydrodynamic forces.

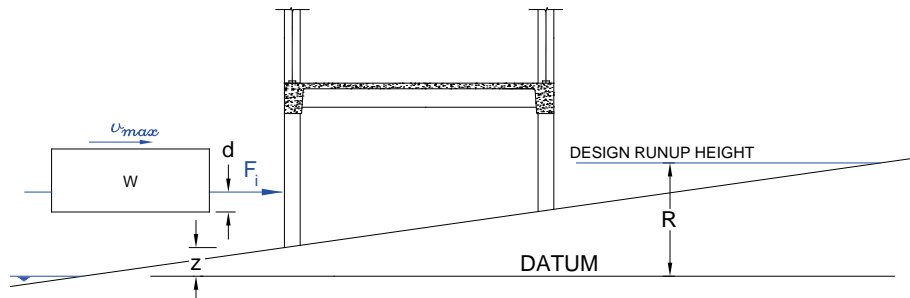

Figure 8-8 Waterborne debris impact force, F_i .

Debris impact forces must be evaluated considering the location of the vertical evacuation refuge structure and potential debris in the surrounding area. For example, it is likely that floating debris would consist primarily of

driftwood, logs, and automobiles for most coastal towns, whereas for some large port areas, the debris could include shipping containers. Locations near fishing harbors and ports must consider possible impact from boats that break free from moorings. ASCE/SEI 7-16 provides a graphical technique to determine whether or not shipping containers, boats, and barges need to be considered based on the proximity of the building site relative to harbors and shipping container storage yards. This approach is based on studies of the distribution of shipping containers and boats after the Tohoku tsunami (Naito, et al., 2014).

Impact by Vehicles. Passenger vehicles are extremely buoyant if the doors are closed, and easily transported by tsunami flow depths exceeding 2 to 3 feet. Vehicles are designed to resist impacts with significant inelastic deformation in order to reduce the forces experienced by passengers. Naito et al. (2014) estimated an impact force of 30,000 pounds for a vehicle traveling at realistic tsunami velocities. This value is prescribed in ASCE/SEI 7-16 for impacts from waterborne vehicles.

8.6.6 Damming of Accumulated Waterborne Debris

The damming effect caused by accumulation of waterborne debris against the exterior of a building is included in ASCE/SEI 7-16 provisions for hydrodynamic force on the overall building and individual exterior structural components. This is achieved through the computation of a closure ratio based on the structural components in the path of the flow, with a minimum ratio determined from field observations and post-tsunami analysis of damaged structures (Chock et al., 2013a; 2013b).

8.6.7 Uplift Forces on Elevated Floors

Uplift forces will be applied to the underside of floor levels in a building that is partially submerged by tsunami inundation. In addition to design for gravity loads, floors must also be designed to resist uplift due to component buoyancy and hydrodynamic forces, F_b . Buoyancy forces, F_b , are shown in Figure 8-9, where A_f is the area of the floor panel or floor framing component, and h_{max} is the maximum inundation depth at the site. When computing buoyant forces on a floor slab, consideration must be given to the potential for increased buoyancy due to the additional volume of water displaced by air trapped below the floor framing system, which can significantly increase the buoyancy force, F_b . In addition, exterior walls at the upper floors will exclude water until their lateral resistance is exceeded by the applied hydrostatic pressure. This can significantly increase the displaced volume of water by an additional height, h_b , contributing to the buoyancy force, F_b .

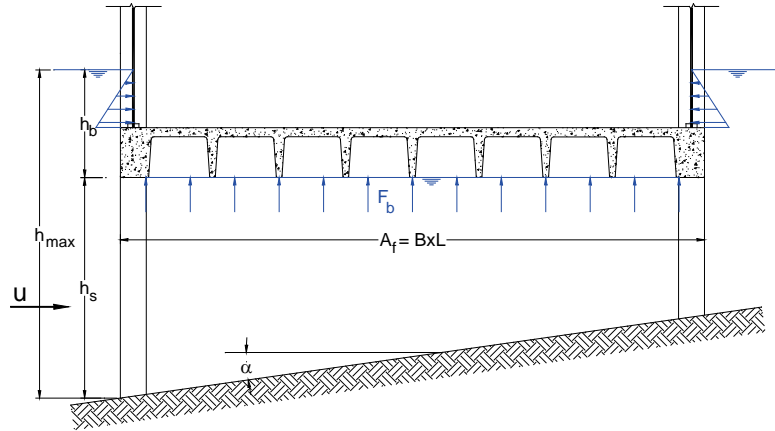

Figure 8-9 Upward buoyant force, F_b , exerted on an elevated floor.

Hydrodynamic forces can also act vertically on floor slabs. During rapid inundation, rising water will apply uplift to the soffit of horizontal structural components, adding to the buoyancy uplift. The presence of structural walls and columns in a building will obstruct the tsunami flow passing through the building, and experiments have shown that this can result in significant uplift forces on the floor slab immediately in front of the obstruction (Ge and Robertson, 2010). ASCE/SEI 7-16 provides slab uplift loads for conditions where a tsunami bore is prevented from passing through the building by a structural wall. It also provides reductions in these forces when openings are provided in the wall or a breakaway wall is provided to relieve the hydrodynamic pressure.

8.6.8 Additional Retained Water Loading on Elevated Floors

During drawdown, water retained on elevated floors will result in additional gravity loading that can exceed the loads for which a floor system was originally designed. The depth of water retained, h_r , will depend on the maximum inundation depth at the site, h_{max} , and the lateral strength of the wall system at the elevated floor. It should be assumed that the exterior wall system will be compromised at some point so that water will eventually inundate submerged floor levels. Because of the rapid rate of drawdown, it is likely that much of this water will be retained at elevated floor levels (at least temporarily). The additional gravity load due to retained water, F_r , is shown in Figure 8-10.

The ASCE/SEI 7-16 tsunami provisions require that elevated floor slabs with perimeter structural components such as an upturned beam, perimeter masonry, or concrete wall or parapet, be designed for the corresponding depth of water retained on the floor during drawdown. For elevated floors

without walls (such as a parking structure with open guardrails) water may remain on elevated floors until it has had time to drain off the structure. Drainage systems should be provided to ensure that the weight of retained water does not exceed the live load for which the floor is designed if the floor is necessary for structural stability.

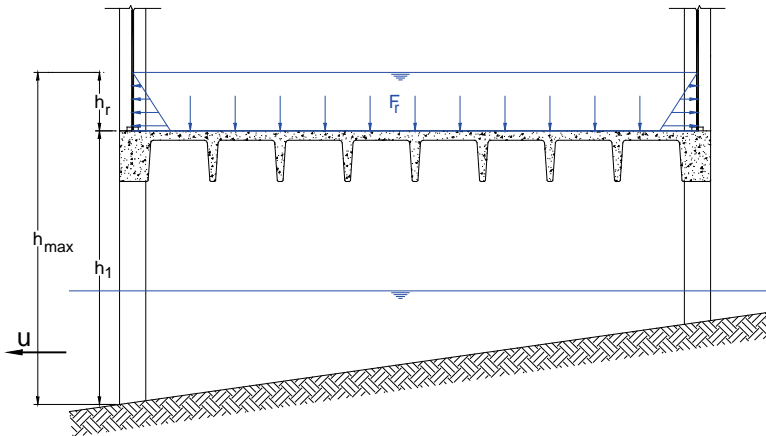

Figure 8-10 Additional gravity load due to retained water, F_r , exerted on an elevated floor during rapid drawdown.

8.7 Combination of Tsunami Forces

Not all tsunami load effects will occur simultaneously, nor will they affect all structural components in a building. This section describes combinations of tsunami forces that should be considered for the overall structure and for individual structural components. Other potential combinations should be considered, as needed.

Not all tsunami load effects occur simultaneously, nor will they affect all structural components in a building.

8.7.1 Tsunami Load Cases Acting on the Overall Structure

ASCE/SEI 7-16 requires that the overall structural system be evaluated for specified load cases.

- Load Case 1 is a combination of buoyancy during initial inundation combined with the corresponding hydrodynamic drag on the overall building. For this load case it is assumed that the exterior walls have not failed, so the interior of the building is still dry, resulting in significant uplift forces due to buoyancy. This has the effect of reducing the total dead weight of the structure, which may impact resistance to overturning and sliding.
- Load Case 2 considers hydrodynamic drag on the overall structure, including the effects of debris damming, at maximum flow velocity. The maximum flow velocity is assumed to occur at $2/3$ of the maximum flow depth at the site.

- Load Case 3 considers hydrodynamic drag on the overall structure, including the effects of debris damming, when the flow depth is at a maximum and the flow velocity is assumed to be $\frac{1}{3}$ of the maximum flow velocity.

Debris impact forces are short duration loads. Because of the extremely short duration associated with debris impact loads, ASCE/SEI 7-16 does not require that impact loads be combined with hydrodynamic forces.

Design of floor systems to withstand the effects of potential hydrodynamic uplift effects and retained water during drawdown can be performed independently of the lateral loading on the overall structure.

8.7.2 Tsunami Load Cases Acting on Individual Components

Tsunami forces are combined on individual structural components (e.g., columns, walls, and beams) as follows:

- Exterior structural elements must be designed to resist hydrodynamic loads associated with Load Cases 2 and 3, including the increased tributary width resulting from debris damming.
- Exterior structural components must also be designed for debris impact. The impact force can be applied as a static load at any location along the submerged component to cause maximum bending moment and maximum shear force in the component. The impact force can also be applied as a short duration dynamic impulse and evaluated dynamically, including component nonlinearity. Finally, the component can also be evaluated using an appropriate energy method. Although it is possible that more than one floating object may impact a building during a tsunami event, the probability of two or more impacts occurring simultaneously is considered small. Therefore, only one impact need be considered to occur at any point in time. Debris impact loads need not be combined with hydrodynamic loads on individual components.
- Interior structural components must be designed for hydrodynamic drag, but need not consider debris damming effects. Observations from past tsunamis indicate that the majority of floating debris accumulates on the exterior of a building with virtually no debris accumulating on interior structural components (Chock, et al., 2013b).
- Interior structural components need not consider impact loads associated with waterborne debris because larger floating objects will be trapped, or at least slowed, by the exterior of the building.

8.8 Tsunami Load Combinations

Load combinations for tsunami load effects are based on load combinations specified in ASCE/SEI 7-16, Section 2.5 for extraordinary events. Tsunami load combinations should be considered in addition to all other load combinations required in ASCE/SEI 7-16.

Tsunami load combinations should be considered in addition to all other load combinations in ASCE/SEI 7-16.

A load factor of 1.0 is used in conjunction with tsunami forces because: (1) the tsunami hazard level corresponding to the Maximum Considered Tsunami is consistent with a 2,475-year return period; and (2) potential variability in tsunami runup elevation is explicitly considered by applying a 30% increase to runup elevations used in tsunami force calculations.

The refuge area in a vertical evacuation structure is assumed to be fully loaded with an assembly live load of 100 psf. The assembly live load represents a practical upper limit for the maximum density of evacuees standing in a refuge area.

Seismic loads are not considered to act in combination with tsunami loads. Although aftershocks are likely to occur, the probability that an aftershock will be equivalent in size to the design level earthquake, and will occur at the same time as the maximum tsunami loading, is considered to be low. However, because seismic design in the U.S. utilizes post-elastic ductility, seismically damaged components may have less available capacity for a subsequently arriving tsunami.

8.9 Progressive Collapse Considerations

Reducing the potential for progressive (i.e., disproportionate) collapse due to the loss of one or more structural components will increase the likelihood that a vertical evacuation refuge structure will remain standing if a column is severely damaged due to waterborne debris. The decision to consider progressive collapse concepts in the design for a particular structure will depend on the site and the nature of the potential debris.

The ASCE/SEI 7-16 permits the use of alternative progressive collapse prevention criteria when loads exceed the acceptability criteria for any structural component, or where necessary to accommodate extraordinary impact loads. Consideration of extraordinary impact loads is required for tsunami vertical evacuation refuge structures located within the debris hazard region of piers and wharves because of the potential for impact from large ships.

In the United States, primary design approaches for progressive collapse prevention include implementation of “alternative load path,” “tie force,” and

“enhanced local resistance” mitigation measures. For essential facility occupancies including emergency shelters, the Department of Defense requires the application of all three measures. The General Services Administration requires the alternative load path design technique to span over a missing vertical load carrying column or wall element.

8.9.1 Department of Defense Methodology

The Department of Defense (DOD) has adopted occupancy-dependent requirements for progressive collapse prevention to address the potential for progressive collapse in the design of facilities using UFC 4-023-03, *Design of Buildings to Resist Progressive Collapse* (DOD, 2016). For Risk Category IV, the designer must provide:

1. Internal, peripheral, and vertical tie force capacities so that the building is mechanically tied together to enhance the development of alternative load paths.
2. Enhanced Local Resistance of the first two stories on the building perimeter, with flexural capacities of columns and walls increased by factors of 2 and 1.5, respectively, over the design flexural strength determined from the alternative load path procedure. The shear capacities of these elements shall be greater than the flexural capacities. For design of vertical evacuation structures it is proposed that these measures be applied to all levels anticipated to be submerged by the tsunami, but not less than the first two stories.
3. Alternative Load Path to enable the structure to bridge over vertical load-bearing elements that are notionally removed one at a time along the exterior.

The tie force strategy is illustrated in Figure 8-11. Tension ties in reinforced concrete structures typically consist of continuous reinforcing steel in beams, columns, slabs, and walls, as shown in Figure 8-12. Reinforcement required for tension ties can be provided in whole, or in part, by steel already sized to resist other actions, such as shear or flexure. In many cases, the quantity of steel provided to resist gravity and lateral forces for typical reinforced concrete structures is also sufficient to develop the necessary tie forces, and it is reasonable to check tie force compliance after a structure is initially designed for gravity and lateral loading.

Ties must be properly spliced and adequately anchored at each end in order to develop their full capacity and perform as anticipated. Reinforcing steel used as tension ties must have lapped, welded, or mechanically joined (Type 1 or Type 2) splices per ACI 318, *Building Code Requirements for Structural*

Concrete (ACI, 2014). Splices should be staggered and located away from joints and regions of high stress.

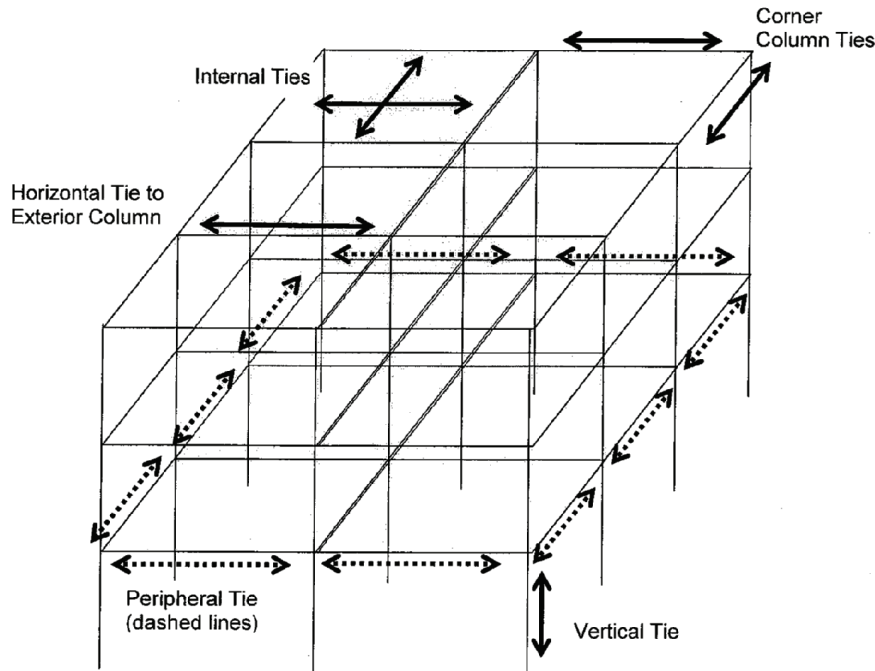

Note: The required Exterior Column, Exterior Wall, and Corner Column Tie forces may be provided partly or wholly by the same reinforcement that is used to meet the Peripheral Tie requirement.

Figure 8-11 Tie force strategy in a frame structure.

Anchorage is critical to the performance of ties, particularly in cases where building layout may be non-typical. Seismic detailing should be used to anchor ties to other ties, or at points of termination (such as at the perimeter of a building). This includes providing seismic hooks and seismic development lengths, as defined in ACI 318.

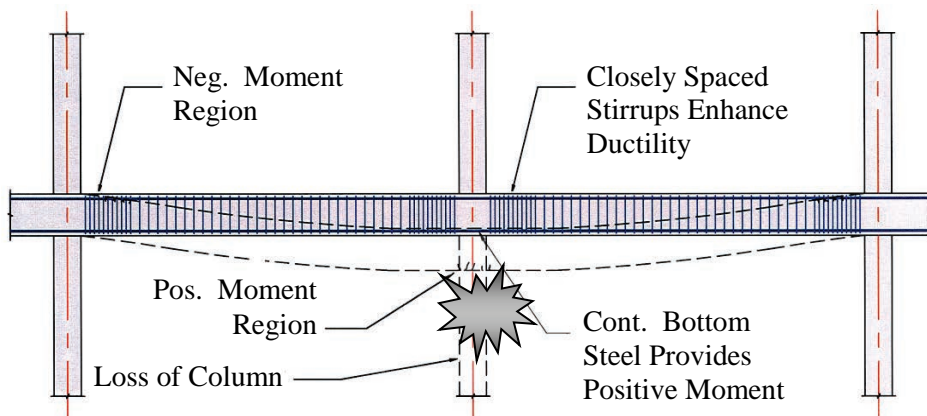

Figure 8-12 Detailing of reinforcing steel in a beam for potential loss of a supporting column.

8.9.2 General Services Administration Methodology

The General Services Administration (GSA) missing column strategy is an independent check performed without consideration of other loads. This approach is based on the concept that loss of a single column, in this case due to impact from waterborne debris, should not result in progressive collapse of the surrounding structural components.

Current progressive collapse criteria are found in *Alternate Path Analysis and Design Guidelines for Progressive Collapse Resistance* (GSA, 2013). As illustrated in Figure 8-13, this strategy requires evaluation of surrounding structural components to continue to support anticipated gravity loads in a series of missing column scenarios.

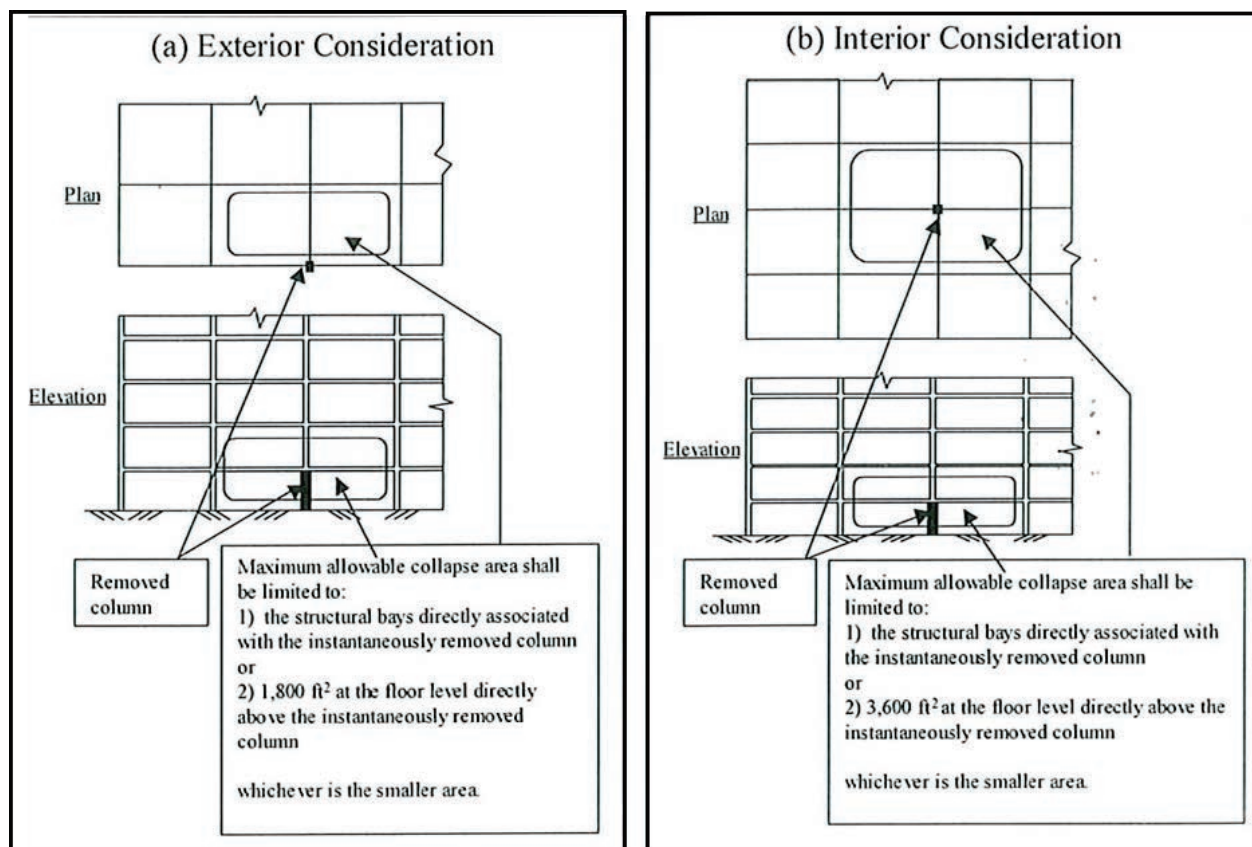

Figure 8-13 Missing column strategy for evaluating the ability of surrounding structural components to support additional gravity loads (GSA, 2013).

Live loads on the building are reduced to simulate those in place at the time the column is damaged. In the case of vertical evacuation structures, full live loads should be considered in the refuge area. Reduced live loads can be considered elsewhere in the building.

The missing column approach utilizes plastic design concepts in evaluating the capability of surrounding structural components to continue to support gravity loads, so some damage in these components is permitted as a result of a missing column scenario. Given that waterborne debris is most likely to impact an exterior or corner column, missing column scenarios should consider the potential loss of exterior columns. Loss of interior columns need not be considered.

8.10 Structural Countermeasures for Tsunami Load Effects

ASCE/SEI 7-16 permits the implementation of structural countermeasures to reduce tsunami load effects related to erosion and scour at foundations, and hydrodynamic loads in the superstructure.

8.10.1 Foundation Scour Design Concepts

ASCE/SEI 7-16 requires that the geotechnical design of the foundation system consider the effects of scour, pore pressure softening, as well as liquefaction due to a preceding earthquake at near-source locations. In many cases, foundation support will consist of deep foundations (i.e., piles). Pile design must consider increased demands due to downdrag and additional lateral forces, and increased unbraced pile length due to scour. The scour depth can be determined by numerical modeling or using an empirical relationship determined from past tsunami observations. Potential uplift from the overall buoyancy of the structure and overturning moments due to hydrodynamic and unbalanced hydrostatic loads must also be accounted for in the foundation design.

Use of protective fill, slabs-on-grade, geotextiles, and reinforced earth systems are permitted countermeasures for design of foundations.

8.10.2 Breakaway Wall Design Concepts

Solid enclosure walls below the tsunami inundation level will result in large hydrodynamic loads. Use of open structures or tsunami breakaway walls are permitted countermeasures for reducing hydrodynamic, buoyancy, and impulsive forces on the overall building and individual structural components.

Use of tsunami breakaway walls is described in ASCE/SEI 7-16, Chapter 6, and design of breakaway walls is covered in ASCE/SEI 7-15, Chapter 5. Breakaway walls must be designed for the required wind loads, earthquake loads, or 10 psf acting perpendicular to the plane of the wall, but without significant overstrength so that the walls will fail at a predictable force level during tsunami inundation.

Standard engineering practice can result in considerable design overstrength, which is detrimental to a breakaway wall system and the supporting structure, and unnecessary conservatism in the design should be avoided. All components, including sheathing, siding, and window frame supports, must be considered in determining the actual strength of the breakaway wall system, and the resulting maximum load on the supporting structure. The most desirable fusing mechanism includes failure of the top and side connections while the bottom connection remains intact, allowing the wall panel to lay down under the tsunami flow without becoming detached and part of the debris flow.

Metal Stud Walls. Metal stud infill walls are commonly used as part of the building envelope. Recent lateral load testing of typical metal stud wall configurations shows that ultimate failure occurs when the studs separate from either the top or bottom tracks. However, the load required to produce this failure is as much as four times the wind load for which the studs were initially designed (Kleinman, et al., 2007). It is therefore necessary to introduce some form of “fuse” at the top track connection to ensure that the wall fails at a predictable load. Such a fuse might include a reduced stud section at the top of the studs. Testing of fuse mechanisms would be required to verify that they have the capacity needed to resist design wind and seismic loads, but will fail at a predictable higher load level.

Masonry Walls. Masonry walls are commonly used as enclosures in lower levels of larger buildings. They can be restrained with the use of a dowel pin fuse system around the top and sides of the wall, without bonded contact to the structure. Such a system should be tested to verify that it will fail at predictable load levels that exceed wind and seismic design loads. If properly fused, the dowel pins will fail and the masonry wall will cantilever from the foundation and load will no longer be applied to the surrounding structural frame. To allow wall failure due to foundation rotation without damage to the remaining structure, separation of the wall foundation from the building foundation should be provided. Gaps between the breakaway masonry wall and structural elements could be filled with appropriate insulation and fire proofing materials.

Considerations for Existing Buildings

Observations from historic tsunami events have shown that building survivability varies with construction type and inundation depth. Although certain types of construction are largely destroyed, there is much evidence that appropriately designed structural systems can survive tsunami inundation, even when not explicitly designed to resist tsunami load effects. This enables consideration of existing buildings as vertical evacuation refuge structures when evacuation to high ground, or to newly constructed refuge structures, is not practically achievable for the affected population.

This chapter outlines special considerations for the use of existing buildings as vertical evacuation refuge structures.

9.1 Attributes of Tsunami-Resistant Structures

The attributes of a structural system have a significant impact on the ability of a structure to withstand anticipated tsunami, earthquake, and wind loading. In regions of high seismicity, the lateral-force-resisting system in typical mid- to high-rise reinforced concrete or structural steel buildings will often be adequate for tsunami loads (Carden, et al., 2017). Structural attributes of buildings that have demonstrated good performance in past tsunamis include:

- strong systems with reserve capacity to resist extreme forces;
- open systems that allow water to flow through with minimal resistance;
- ductile systems that resist extreme forces without failure; and
- redundant systems that can experience partial failure without disproportionate collapse.

9.2 Criteria for Evaluation of Existing Buildings

To be designated a vertical evacuation refuge, a building, whether it is new or existing, must meet the requirements in ASCE/SEI 7-16 for tsunami vertical evacuation refuge structures. ASCE/SEI 7-16 includes an alternative performance-based structural design procedure that is based on procedures contained in ASCE/SEI 41-13, *Seismic Evaluation and Retrofit of Existing Buildings* (ASCE, 2014b). Although there are significant differences

The alternative performance-based design procedure, based on procedures contained in ASCE/SEI 41-13, *Seismic Evaluation and Retrofit of Existing Buildings*, is likely to be most appropriate for evaluation of existing buildings.

between tsunami and earthquake loading, the alternative performance-based procedure is likely to be most appropriate for evaluation of existing buildings.

Earthquake loads consist of short-term, dynamic, cyclic loading. Except for debris impact, tsunami loads are considered sustained actions, and components are protected from strength degradation under sustained forces. In the alternative performance-based procedure, forces and displacements are determined using linear or nonlinear static analysis, and demands are checked against component design strengths or expected strengths using procedures that are similar to, but different from, strength concepts in ASCE/SEI 41-13:

- In ASCE/SEI 41-13, component actions are classified as strength-controlled or deformation-controlled. Strength-controlled actions are checked against lower-bound component strengths, and deformation-controlled action are checked against component expected strengths.
- In ASCE/SEI 7-16, actions are classified as force-sustained or ductility-governed. Strength degradation is not permitted under force-sustained actions, and component demands are checked against specified design strengths, including material resistance factors, ϕ . For ductility-governed actions, component demands are checked against expected strengths calculated in accordance with ASCE/SEI 41-13.

Evaluation of an existing building requires precise knowledge of material properties and as-built conditions of the structure. Available design and construction information on existing buildings, however, is often limited or incomplete. ASCE/SEI 41-13 includes procedures for sampling material properties and investigating as-built construction in sufficient detail for performing structural analysis.

9.3 Considerations for Existing Buildings

Existing buildings considered for use as vertical evacuation refuge structures should possess the structural attributes associated with tsunami-resistant construction identified in Section 9.1.

Existing buildings considered for use as vertical evacuation refuge structures should possess the structural attributes associated with tsunami-resistant construction identified in Section 9.1.

Existing building owners must be agreeable to the use of the building as a vertical evacuation refuge. Preference should, therefore, be given to buildings owned by city, county, state, federal, or tribal entities. Hotels, office and residential buildings could also be considered; at a minimum, they can provide refuge for the occupants of the building.

The following attributes should be considered in the selection of existing buildings for potential use as vertical evacuation refuge structures:

- **Building Height.** It is essential that potential refuge areas in existing buildings are at, or above, elevations that satisfy minimum height requirements for vertical evacuation refuge structures in ASCE/SEI 7-16.

Taller buildings that exceed minimum height requirements will provide an additional margin of safety against tsunami inundation that exceeds the design inundation depth. Taller buildings will also be able to accommodate more evacuees, and are more likely to have stronger lateral-force-resisting systems due to increased seismic and wind design requirements.

- **Building Location.** Vertical evacuation requires a distribution of structures throughout a community, and building location can result in exposure to different potential site hazards such as fuel depots, shipping container storage yards, boat harbors, and adjacent buildings that could possibly collapse. Where possible, existing buildings should be selected at locations that minimize potential for site hazards that could compromise access to, or the survivability of, a refuge structure.
- **Building Orientation.** Orientation can impact the magnitude of tsunami forces. Rectangular buildings with the long direction oriented parallel to the direction of flow will experience smaller hydrodynamic forces than buildings oriented with the long direction perpendicular to the direction of flow. Where possible, existing buildings should be selected with orientations that minimize potential tsunami load effects.
- **Structural System.** Reinforced concrete or structural steel moment-resisting frames, and reinforced concrete shear wall systems, designed to higher seismic requirements, are generally more suitable for providing adequate tsunami resistance. Light-frame wood or metal stud structural systems should not be considered. Precast concrete structures may require extensive strengthening of connections, unless they were designed to simulate integral construction.
- **Vintage of Construction.** Building code requirements are continually changing. Newer buildings constructed to more recent editions of the building code are more likely to provide adequate tsunami resistance.

For example, major enhancements to U.S. seismic design requirements for reinforced concrete structures occurred following the 1971 San Fernando earthquake, and concrete buildings constructed after the 1973 edition of the building code will have enhanced robustness over older concrete construction. Similarly, major enhancements to steel moment-

resisting frame construction occurred following the 1994 Northridge earthquake, and steel frame structures constructed after 1995 will have enhanced robustness over older steel frame construction. ASCE/SEI 41-13 identifies vintages of construction for different structural systems that are considered adequate for seismic resistance, termed benchmark buildings. Seismic benchmark buildings are a good starting point for selection as vertical evacuation refuge structures.

- **Foundation System.** Because of the potential for erosion and scour during tsunami inundation, existing buildings with deep pile foundations are generally more suitable for providing adequate tsunami resistance. Buildings with shallow spread footings should be avoided unless they are founded on rock or other scour-resistant material or have otherwise been protected from scour.

9.3.1 Concepts for Retrofitting Existing Buildings

Based on linear or nonlinear static (i.e., pushover) analysis using the alternative performance-based structural design procedure, it is possible that retrofit may only be required for individual structural members (e.g., columns, beams, and shear walls) at selected locations (e.g., at the roof or lower inundated levels) of an existing building.

The following concepts can be considered for the modification and retrofit of existing buildings for potential use as vertical evacuation refuge structures:

- **Roof system.** Roof systems may need to be upgraded to support additional live loads associated with refuge occupancy. Existing building functions at the roof level (e.g., mechanical equipment) that would be unsafe in the immediate vicinity of high occupancy areas should be protected or relocated. Existing roof parapets should be modified for fall protection of refuge occupants.
- **Wall System.** Nonstructural walls and wall connections in the lower levels of the building can be modified to perform as breakaway walls to minimize tsunami hydrostatic, hydrodynamic, and surge forces on the building.
- **Floor systems.** Ground floor and elevated floor systems will experience buoyancy and uplift effects. At the ground floor, buoyancy effects can be alleviated if the ground floor slab is a nonstructural slab-on-grade isolated from grade beams, foundations, and columns. Elevated floor systems with prestressed beams and slabs or concrete slab-on-metal-deck will be particularly susceptible to damage due to uplift forces, and will require special attention. Strategies could include reducing the potential

for entrapped air, which contributes to buoyancy effects, or removing restrictions to the flow of water around floor levels.

- **Access.** Access and vertical circulation may need to be improved through the installation of new entrances, ramps, and stairs. Access corridors must be kept clear of debris following an earthquake that could precede a near-source-generated tsunami, so attention to nonstructural component bracing and anchorage is necessary.

Supplemental access can be installed on the outside of the building for ease of construction and high visibility. Figure 9-1 shows a building in Kesenuma, Japan, that served as a vertical evacuation refuge in the 2011 Tohoku tsunami, with an exterior metal staircase installed to provide unobstructed access to the refuge area on the roof.



Figure 9-1 Five-story building in Kesenuma, Japan, with an exterior metal staircase installed to provide unobstructed access to the refuge area on the roof (Fraser et al., 2012).

9.4 Tsunami Refuge of Last Resort

In some cases, it may not be feasible to construct new buildings or retrofit existing buildings to provide adequate vertical evacuation refuge in a community. An alternative that could be considered is to identify buildings or structures that could serve as a tsunami refuge of last resort.

A study by Chock et al. (2018) compared overall tsunami hydrodynamic forces with the capacity provided by the seismic design base shear for prototypical Risk Category II (standard occupancy) structures in various

locations. Lateral-force-resisting systems included steel moment-resisting frames and reinforced concrete shear walls, designed and detailed to meet current ASCE/SEI 7-16 requirements for Seismic Design Category D.

Results from Chock et al. (2018) for selected locations in California, Oregon and Washington, and from a similar analysis by Carden et al. (2016) for locations in Hawaii, are provided in Table 9-1. The studies showed that buildings of a certain height, designed to Risk Category II seismic design requirements, can provide adequate resistance to tsunami forces at some level of inundation depth.

Table 9-1 Tsunami Load to Seismic Capacity Building Height Parity and Threshold for Selected Locations on the U.S. Pacific Coast

Location	Maximum Inundation Depth (ft)	Height of Parity between Tsunami Load and Seismic Capacity (ft)		Threshold Height for RC II Buildings ¹
		Steel Moment Frame	Concrete Shear Wall	
Crescent City, CA	19	15	15	35 ²
Eureka, CA	14	<10	<10	30 ²
Santa Cruz, CA	14	<10	<10	30 ²
Port Hueneme, CA	5	<10	<10	25 ²
Seaside, OR	40	60	60	55 ³
Cannon Beach, OR	57	>85	>85	70 ³
Newport, OR	18	15	15	30 ²
Seattle, WA	20	20	20	35 ²
Ocean Shores, WA	14	20	20	30 ²
Long Beach, WA	47	>85	85	60 ³
Hilo, HI	72	>85	>85	85 ⁴
Kahului, HI	60	>85	>85	75 ⁴
Honolulu, HI	24	35	20	40 ²
Haleiwa, HI	61	>85	>85	75 ⁴

- Notes: 1. The threshold height is the mean height of the structure above the grade plane, taken as the maximum inundation depth plus 12 feet, rounded up to the nearest 5 feet, but not less than 25 feet.
2. At locations noted, strengthening of building systems meeting current ASCE/SEI 7-16 Risk Category II seismic design requirements would not be necessary.
3. At locations noted, strengthening in excess of seismic design requirements may be necessary to resist tsunami loads.
4. At locations noted, use of Risk Category II buildings for tsunamis is not recommended due to extreme tsunami loading.

In Table 9-1, equivalence between seismic capacity and the demand associated with tsunami inundation depth at a given location is termed the parity height. The maximum inundation depth is based on the tsunami hazard at the site, and the threshold height is the height of the building needed to provide adequate freeboard above inundation (in this study, computed as the inundation depth plus 12 feet, rounded up to the nearest 5 feet, but not less than 25 feet).

In a given community, existing buildings that are taller than the required threshold height might be considered for vertical evacuation refuge. This study shows that buildings taller than the parity height would have adequate resistance to tsunami loads. Locations in the table where the parity height is less than the threshold height are locations where taller existing buildings would be expected to be adequate for the loads associated with the anticipated tsunami inundation depth. The study concluded that taller structures in a community can provide effective secondary alternative refuge when evacuation out of the inundation zone is not possible or practically achievable for the entire population. Such structures can be considered a tsunami refuge of last resort.

It is important to note that the details in these studies are predicated on buildings designed to current ASCE/SEI 7-16 seismic standards. This will not be the case for most existing buildings. For buildings designed to earlier codes, it will be necessary to confirm the parity height using the procedure outlined in Chock et al. (2018). Also, these studies were limited to hydrodynamic load effects on the overall lateral-force-resisting system. It does not address the strength and integrity of individual components that are not part of the lateral-force-resisting system, and does not address impact from waterborne debris.

The conclusions from these studies, however, are proof of concept that existing buildings of a certain size, construction, and design capacity can be considered as a tsunami refuge of last resort where no better alternatives exist.

Existing buildings of a certain size, construction, and design capacity can be considered as a tsunami refuge of last resort where no better alternatives exist.

Appendix A

Vertical Evacuation Structure Examples

This appendix provides examples of designated vertical evacuation refuge structures that have been constructed in the United States and Japan.

Ocosta Elementary School. The first tsunami vertical evacuation structure in the United States was constructed in 2016 at the campus of Ocosta Elementary School in Westport, Washington (Figure A-1). This school is located on a low-lying peninsula that is anticipated to be overtopped during a maximum considered tsunami event from the Cascadia Subduction zone. Horizontal evacuation to high ground is particularly problematic because of the long distance and travel time, and the potential for seismic damage to the bridge connecting the peninsula to Bay City (Figure A-1). When site-specific tsunami inundation modeling indicated that the school location was anticipated to be subjected to 5 feet of inundation, the local community initiated a referendum to authorize a bond issue to cover the additional cost of adding a tsunami vertical evacuation refuge to the new school buildings.

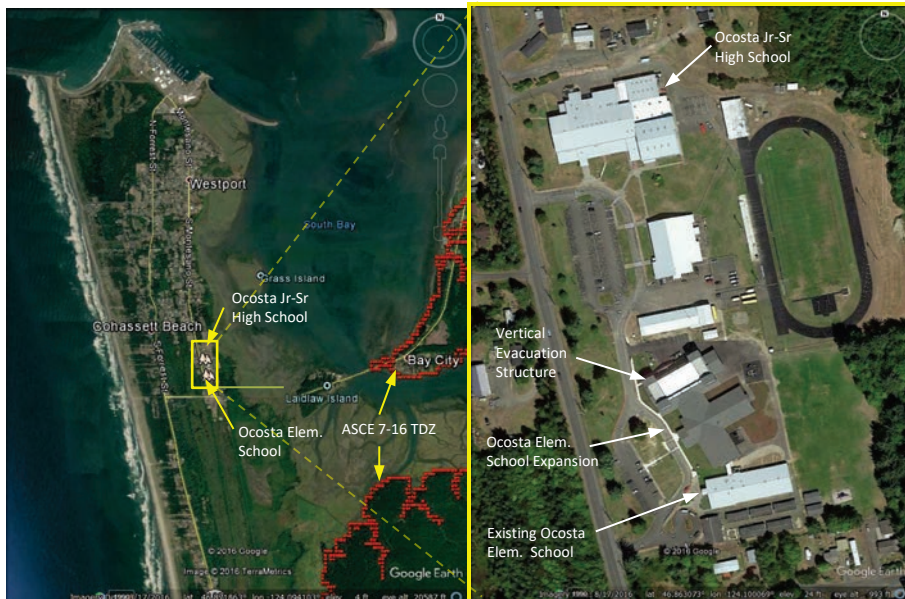

Figure A-1 Location of Ocosta Elementary and Junior-Senior High Schools, Westport, Washington.

The building selected was the activity wing, housing a gymnasium, cafeteria and music room, which was planned to have a roof elevation of 28 feet above grade and 53 feet above mean sea level (Figure A-2) (Ash, 2015). This elevation satisfied ASCE/SEI 7-16 height requirements for a refuge, so the building was designed as a tsunami vertical evacuation refuge structure in accordance with ASCE/SEI 7-16 and FEMA P-646 procedures.

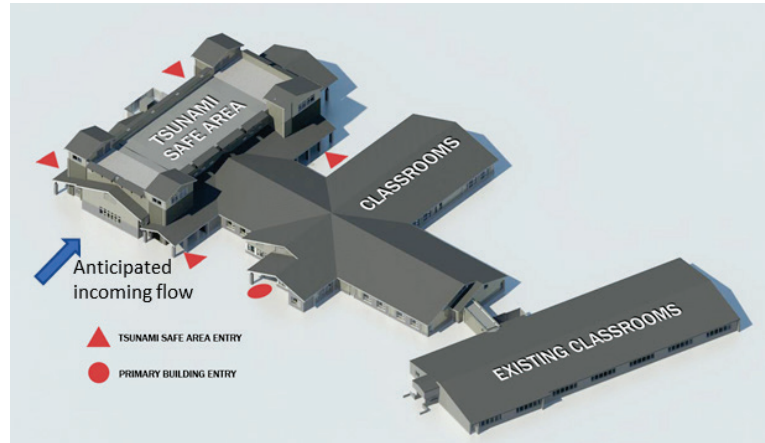

Figure A-2 Tsunami refuge area on roof of new activities wing at Ocosta Elementary School (image courtesy ASCE and TCF Architecture).

Four stair cores surrounded by 14-inch thick special reinforced concrete shear walls were designed at each corner of the building to provide access to the refuge on the roof, and to serve as the lateral-force-resisting system for both seismic and tsunami loads (Figure A-3). The shear walls were designed such that failure of an individual pier or wall segment would not result in collapse of the wall. The steel columns supporting the rooftop refuge were encased in concrete at the lower levels, with moment-resisting beam-column connections at the roof level so that the loss of an individual column would not result in collapse of the roof structure (Figure A-3).

The deep pile foundations that were already required for seismic and liquefaction requirements were augmented to provide sufficient lateral strength considering the maximum scour anticipated in ASCE/SEI 7-16 provisions.

Access to the refuge area is provided by two pairs of doors at each stair core. Ingress doors open inward and egress doors open outward. For security purposes, both sets of doors open at the exterior of the building and are equipped with security features that prevent access except in the event of an emergency. Fail-safe measures are provided to ensure access in the event of a power failure or other disruption to the building's security system. One stair tower includes an elevator for normal maintenance access, but the

elevator is not used during evacuation drills, as power is likely to be disrupted in a design level earthquake (Ash, 2015).

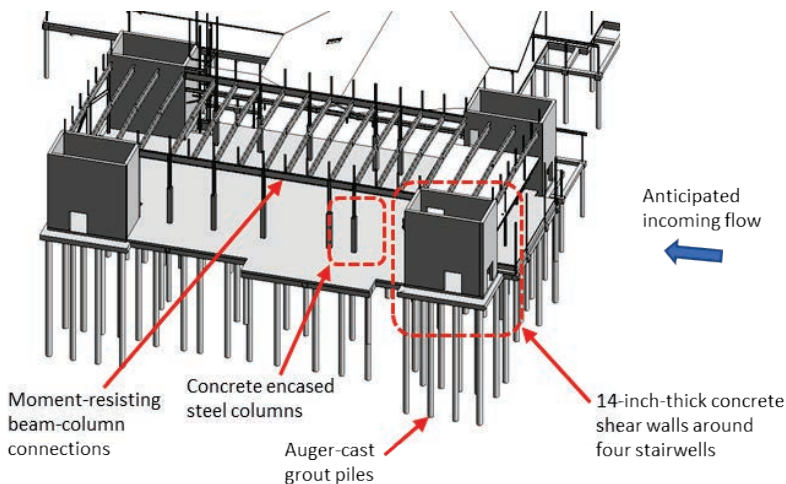

Figure A-3 Structural system details for the new activities wing and tsunami refuge structure (image courtesy ASCE and TCF Architecture).

This refuge provides sufficient space for over 1,000 people, which should be adequate to accommodate all students from the elementary school and the neighboring junior-senior high school, while also providing a refuge space for members of the local community who are not able to evacuate to high ground.

The additional cost to transform the gymnasium roof into a vertical evacuation refuge was approximately \$2 million out of a total construction cost of \$13.8 million, or a 17% premium. This cost premium was somewhat higher than expected, and is attributed to the special case of upgrading the roof from a light-frame metal structure designed for intermittent access to a bearing structure designed for assembly use. Typical cost premiums are expected to be lower, especially in multi-story buildings, because of inherent strength and ductility in the structural system resulting from seismic design requirements.

Examples in Japan. In Japan there are numerous examples of structures that were designed and constructed for the purpose of tsunami refuge. The Government of Japan, Director-General for Policy Planning, published *Guidelines for Tsunami Evacuation Buildings* in Japanese in June 1995 (DGPP, 1995). An English explanation is provided in *Structural Design Method of Buildings for Tsunami Resistance* (Okada, et al., 2005), which has been used for design of vertical evacuation structures such as the apartment building in Minamisanriku, Japan, shown in Chapter 2 (Figure 2-23).

A number of multi-story reinforced concrete and structural steel buildings in Japan were designated as vertical evacuation buildings prior to the Tohoku tsunami. All performed well structurally, though many were too low for the actual inundation depth, resulting in loss of life (Murakami et al., 2012). Figure A-4 shows such a building in Kesennuma Port that was successfully used by refugees during the tsunami. As reported in the Yomiuri Shimbun (2012), over 4,000 buildings and other structures in Japan are now officially designated for use as vertical evacuation refuges.



Figure A-4 Successful designated vertical evacuation building in Kesennuma Port, Japan.

Nishiki Tower. The Nishiki Tower, shown in Figure A-5, was constructed in the town of Kise, Mie Prefecture, Japan (Kisei, 2008). The five-story, 22-meter tall reinforced concrete structure resembles a lighthouse, and has a spiral staircase winding up the outside of the building. It was specifically designed to serve as a tsunami refuge, but is used for other (non-refuge) purposes on normal days. The first floor is used for public restrooms and storage space for fire equipment; the second floor for a meeting room; and the third floor for an archival library of natural disasters. The fourth and fifth floors have 73 square meters of refuge space for evacuees.

Nishiki Tower is a well-engineered structure that is designed to withstand a seismic event commensurate to JMA VII on the Japanese earthquake intensity scale, which is comparable to a MMI XII (modified Mercalli scale). The building is founded on a 4-meter deep sand-and-gravel layer, and is supported on concrete piles extending 6 meters below grade. The possibility

of liquefaction is remote, considering the large particle size of the sand-and-gravel layer. Elastic design was employed for consideration of tsunami forces. Based on historical data from the 1944 Tou-Nankaido Earthquake, a design tsunami of 6 meters in height was used for design. It was designed to withstand the impact of a 10-ton ship at a velocity of 10 m/sec. This criterion was based on the size of ships moored in the neighboring port. The intended performance level allows for partial damage of the building without incurring loss of life.



Figure A-5 Nishiki Tower in Kise, Japan.

Elevated Shelter at Shirahama Beach Resort. An aesthetically pleasing reinforced concrete tsunami refuge structure, shown in Figure A-6, was constructed at a beach resort in the town of Shirahama, Tokushima Prefecture, Japan. It was designed to accommodate 700 refugees in an area of 700 square meters. The design inundation elevation is 7.5 meters, based on historical data from the 1854 Ansei-Tokai Earthquake (M 8.4) and resulting tsunami. With a planned freeboard of 4 meters, the evacuation platform is located at an elevation of 11.5 meters. It should be noted that this refuge elevation is lower than current recommendations in this report and requirements in ASCE/SEI 7-16. The structure was designed to withstand a maximum base acceleration of 0.78 g. Because of a potential for soil

liquefaction, pipe piles were driven approximately 20 meters deep into bedrock. The facility is also equipped with a solar-powered lighting system.



Figure A-6 Refuge at Shirahama Beach Resort, Japan (photo courtesy of N. Shuto).

Other Tsunami Refuge Structures. Other structures in Japan specifically designed as tsunami refuges include a reinforced concrete structure, shown in Figure A-7, that was constructed in the town of Kaifu, Tokushima Prefecture, Japan, and an artificial high ground berm, shown in Figure A-8, that was constructed in Aonae, Japan, where the 1993 Okushiri tsunami was most severe.



Figure A-7 Tsunami refuge in Kaifu, Japan.



Figure A-8 Berm constructed for tsunami refuge in Aonae, Japan.

Community Design Example

This appendix illustrates the initial design and configuration of a series of vertical evacuation structures in a hypothetical community.

A hypothetical community is indicated in Figure B-1 below. The community has evaluated public and private sites that might be appropriate for construction of new vertical evacuation structures and identified existing facilities for possible renovation for use as vertical evacuation structures. This evaluation includes consideration of the number of sites required based on travel time and population, as discussed in Chapter 6.

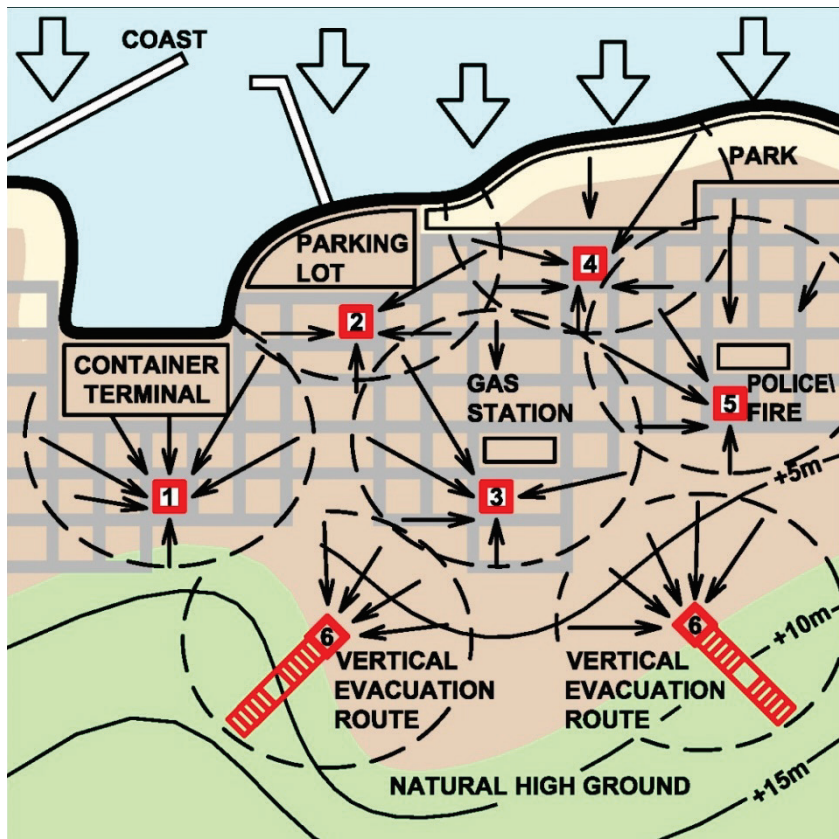

Figure B-1 Hypothetical sketch of example community showing an evacuation zone (dark shading), potential vertical evacuation structure sites, and evacuation routes.

A site-specific tsunami inundation study is required to determine 2,500-year return period maximum flow depths and flow velocities needed to assess tsunami effects within the community and to determine tsunami design loads. Hypothetical predicted tsunami inundation depths for this example community are shown in Figure B-2.

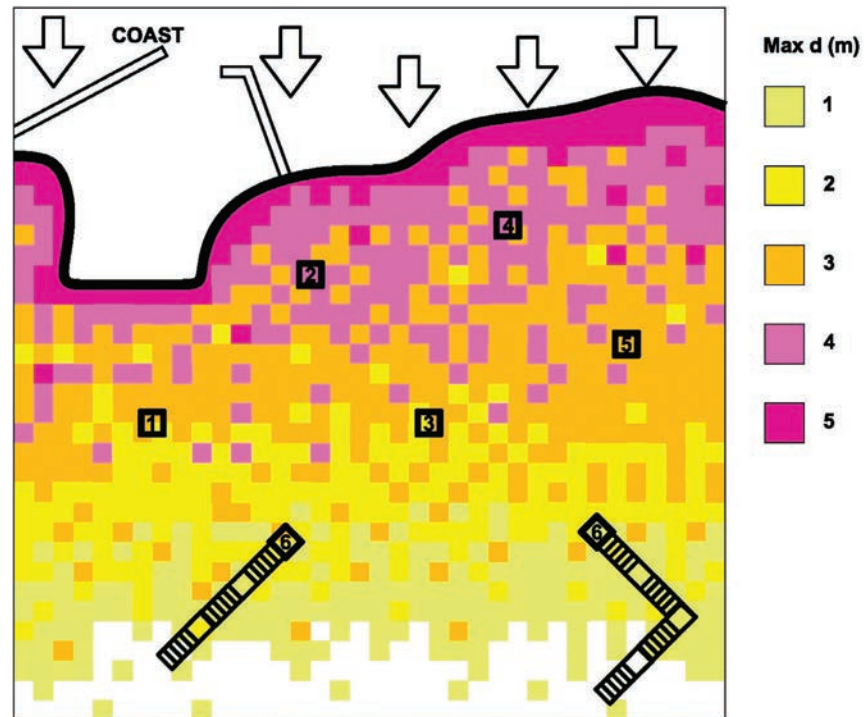

Figure B-2 Example community inundation map. Colored areas show predicted tsunami inundation depth, h .

In this example community, the area of refuge at each site would need to be elevated as indicated in Table B-1.

Table B-1 Design Elevations for Areas of Refuge

Site	Site Elevation	Predicted Inundation Depth	Predicted Inundation Elevation	Freeboard (3 meters plus 30%)	Design Elevation
Site 1	2 m	3 m	5 m	3 m + 1.5 m	9.5 m
Site 2	1 m	4 m	5 m	3 m + 1.5 m	9.5 m
Site 3	3 m	3 m	6 m	3 m + 1.8 m	10.8 m
Site 4	1 m	4 m	5 m	3 m + 1.5 m	9.5 m
Site 5	4 m	3 m	7 m	3 m + 2.1 m	12.1 m

Tsunami inundation elevations, which are the site elevation plus the predicted inundation depth indicated in Figure B-2, are increased by 30% to account for local variability in numerical simulations. An additional minimum freeboard of 3 meters or one-story height (whichever is greater) is

required to ensure that the area of refuge is not inundated from splash or wave action.

The velocity at a particular site is affected by the surrounding topography as well as natural and man-made obstructions to flow. Hypothetical predicted flow velocities for this example community are shown in Figure B-3 and summarized in Table B-2.

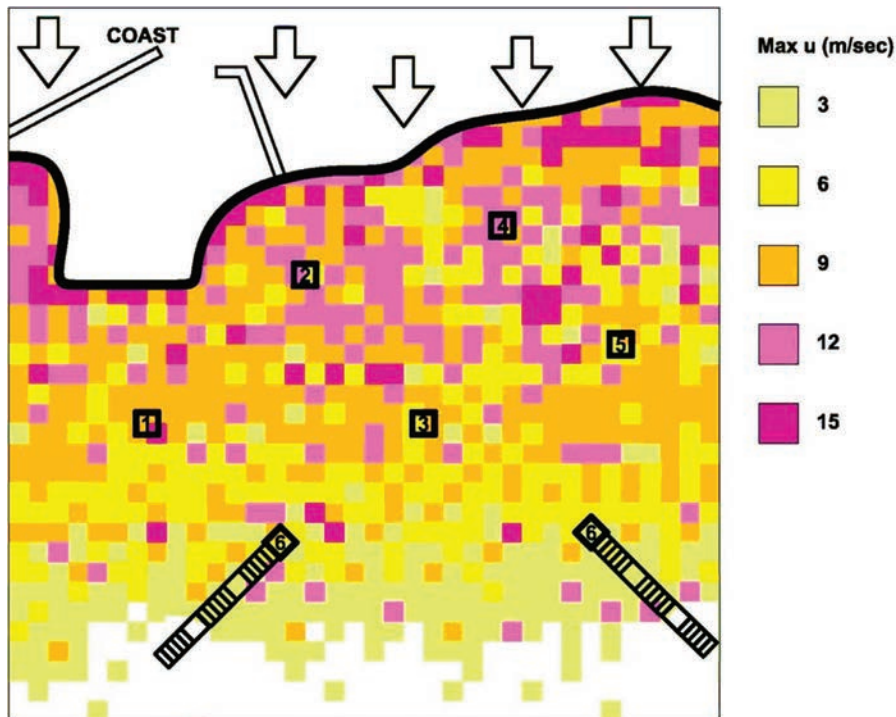

Figure B-3 Example community inundation flow velocity map. Colored areas show various predicted tsunami flow velocities, u .

Table B-2 Tsunami Flow Velocity at Each Site

Site	Tsunami Flow Velocity
Site 1	15 m/s
Site 2	12 m/s
Site 3	9 m/s
Site 4	12 m/s
Site 5	9 m/s

B.1 Site 1 Example: Escape Berm

Site 1 has several unique conditions to consider. The waterfront in this area is somewhat industrial in nature and includes a container terminal facility at the harbor. Areas adjacent to the site contain some residential development.

The evacuation population at this site would include both employees of the harbor industrial area and adjacent residences.

The community has been struggling with finding ways to address other social issues in this area, which have included a lack of recreational facilities for the residents, some neglected and deteriorating properties, and a need to revitalize and enhance the area. At this site a man-made berm, as shown in Figure B-4, provides an opportunity to add new public open space in addition to vertical evacuation refuge. This solution creates a unique elevated park setting for the community, which addresses recreational needs, and provides a scenic overlook for the waterfront.

With a location adjacent to a container terminal facility, there is a potential for shipping containers to become waterborne debris. Construction of the berm utilizing sheet piles to contain the fill addresses this issue.

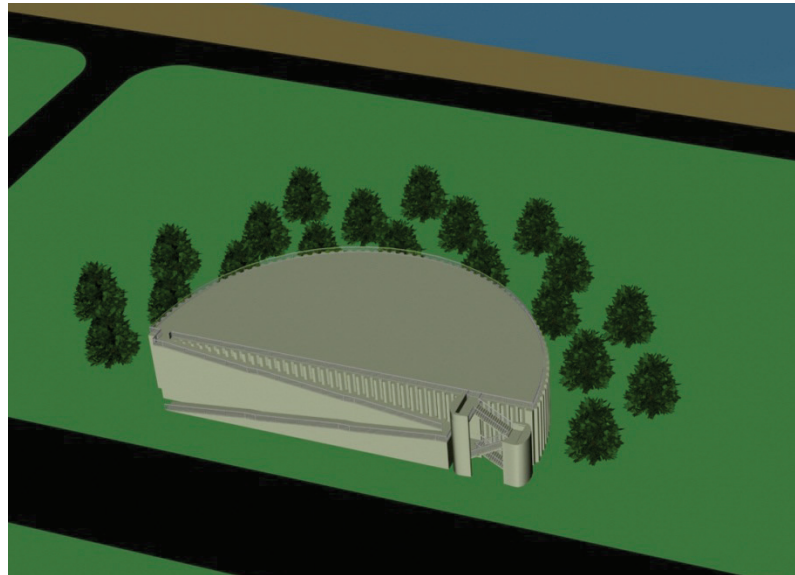

Figure B-4 Example escape berm design.

The escape berm, illustrated in Figure B-5, includes the following features:

- **Note 1 (Figure B-5).** The semicircular configuration was selected to help divert tsunami flood waters and potential waterborne debris around the facility and away from the access stairs and ramp. The elevated area is over 31,000 square feet, and can accommodate over 3,000 evacuees at 10 square feet per person. There is sufficient space in the elevated area to accommodate a comfort station that could be used for both day-to-day recreational purposes and emergency use.

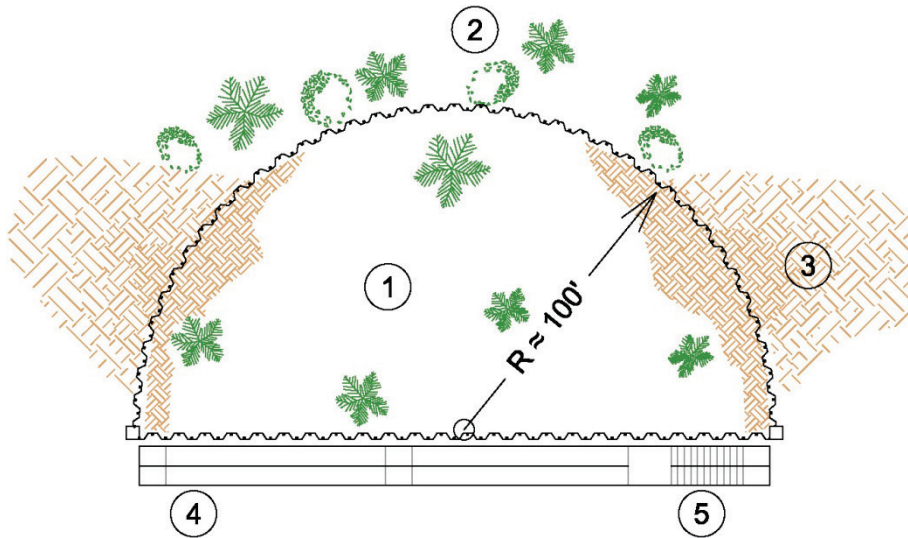

Figure B-5 Example escape berm plan layout.

- **Note 2 (Figure B-5).** The ocean-facing side of the berm is essentially vertical to prevent tsunami flood waters and potential floating debris from moving upslope into the area of refuge. Trees and other landscaping can be used to hide the vertical face and create an aesthetically appealing feature.
- **Note 3 (Figure B-5).** The sides of the berm can be sloped to provide additional access to the area of vertical refuge. Care should be taken to orient the slope so that water and debris are not inadvertently channeled upslope.
- **Notes 4 and 5 (Figure B-5).** A ramp and stairs provide primary access for both recreational and emergency purposes.

Additional features are illustrated in Figures B-6 and B-7 and described below.

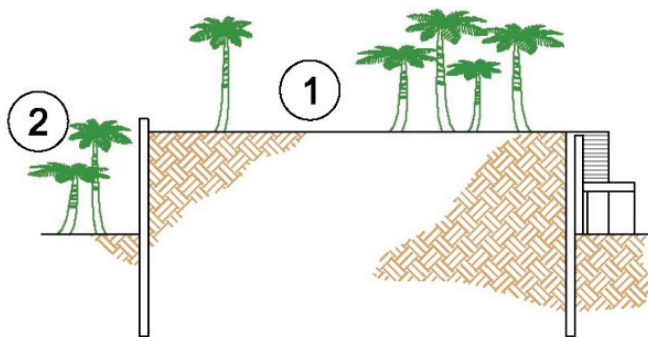

Figure B-6 Example escape berm section.

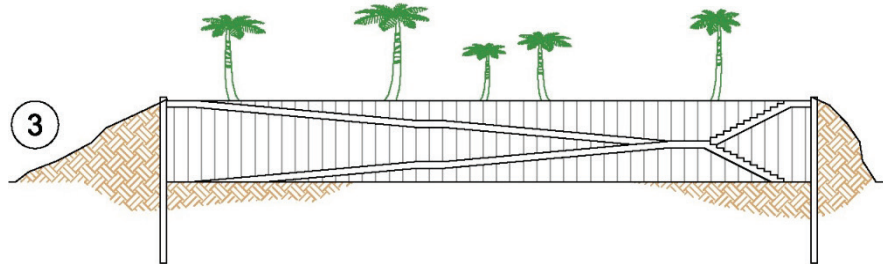

Figure B-7 Example escape berm rear elevation.

- Note 1 (Figure B-6).** Where the elevated area is adjacent to a steep drop off, guard rails or walls of appropriate size and height should be provided for fall protection. Using a solid wall for the guardrail will have the added benefit of providing additional protection from tsunami runup or splash onto the area of refuge. Walls can be configured to divert splash away from the wall.
- Note 2 (Figure B-6).** The sheet piles used to create the berm will need to be constructed deep enough below existing grade to ensure that the retaining system is not undermined by scour around the perimeter of the berm.
- Note 3 (Figure B-7).** With sufficient length, both ADA compliant ramps and stairs can be provided. This will address both the day to day recreational use of the facility as well as emergency evacuation needs. Sloped surfaces on the sides of the berm can be used to provide additional access, and can also help channel floating debris away from the base of the ramps and stairs to minimize the risk of blockage.

B.2 Site 2 Example: Multi-Use Structure

Site 2 is situated on property managed by the school district. The site is located adjacent to an existing school and the surrounding area contains a combination of residential and business use. The existing school is located well within the inundation zone. The waterfront in this area includes an on-grade parking lot that services businesses in the area, and a nearby oceanfront park. The evacuation population at this site would include children attending the school, neighbors in the adjacent residences, employees of nearby businesses, and users of the nearby oceanfront park.

The school district has had an ongoing need for a covered gymnasium. At this site, the community has decided to incorporate the roof of the proposed gymnasium into its emergency planning. It is decided that this new structure will be designed to meet the requirements for a vertical evacuation structure to serve two important community needs. The structure is illustrated in Figure B-8.

Located adjacent to an on-grade parking lot, the structure will need to be designed for potential impacts from floating vehicles, rolling boulders, and logs as required in ASCE/SEI 7-16. If the community is located in a climate that requires the gymnasium to be enclosed, special attention should be paid to the design of the exterior wall system. Walls should be detailed as breakaway walls to minimize tsunami loading on the overall structure. Otherwise the structure will need to be designed for the corresponding increase in hydrostatic, hydrodynamic, and impulse loads.

As a school facility, the building must also be designed to address typical health and safety requirements for school facilities in normal use (when not serving as a vertical evacuation refuge).

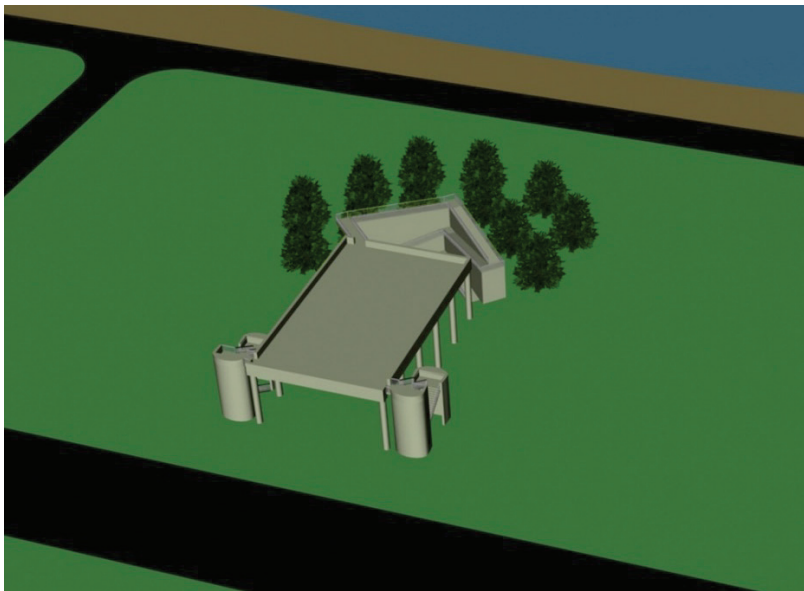

Figure B-8 Example covered gymnasium.

The multi-use structure, illustrated in Figure B-9 and Figure B-10, includes the following features:

- **Note 1 (Figure B-9).** The rectangular layout was selected based on the gymnasium requirements for the school. The elevated area is over 10,000 square feet in size, and can accommodate over 1,000 evacuees at 10 square feet per person. Using available census information, it was determined that this should be sufficient for the school and surrounding area that this facility is intended to serve.
- **Note 2 (Figure B-9).** Stair access is provided by a stair structure surrounded by reinforced concrete structural walls that will have sufficient strength for both seismic and tsunami loads. The shape is intended to channel tsunami flow and potential debris away from both the structure and the stair system.

- **Note 3 (Figure B-9).** An ADA accessible ramp system is considered for a future phase of the project. This could utilize sheet piles and fill to further channel tsunami flow and waterborne debris away from the structure.

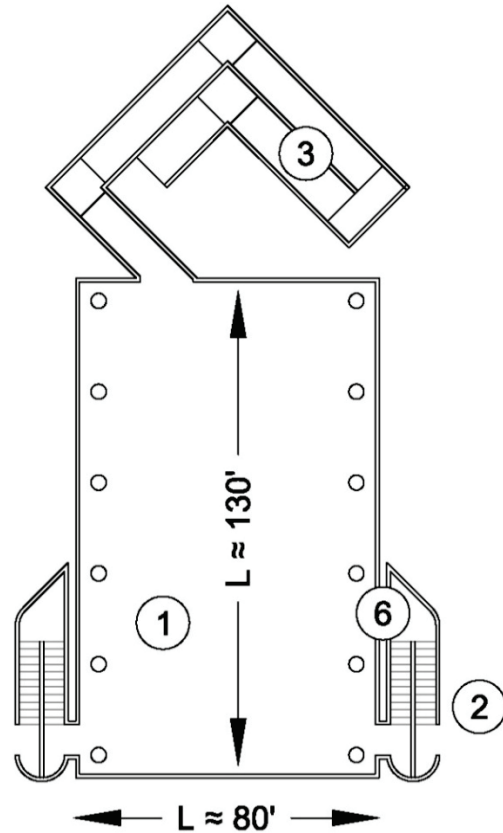

Figure B-9 Example gymnasium plan.

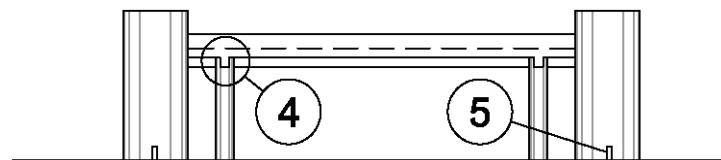

Figure B-10 Example gymnasium elevation.

- **Note 4 (Figure B-10).** The structural system utilizes a concrete moment frame to create an open lower level that will keep hydrodynamic loads on the structure to a minimum. This includes the use circular columns.
- **Note 5 (Figure B-10).** Additional strength can be provided in the system using walls that are parallel to the anticipated direction of the tsunami inundation flow.
- **Note 6 (Figure B-9).** Stair structures can be integrated with the primary structure to provide additional strength, or they can be made structurally independent.

Glossary

The following definitions are provided to explain the terms and acronyms used throughout this document. Many have been taken from FEMA 55, *Coastal Construction Manual* (FEMA, 2011) or ASCE/SEI 7-16, *Minimum Design Loads and Associated Criteria for Buildings and Other Structures* (ASCE, 2016).

A

ADCIRC. ADvanced CIRCulation.

ADA. Americans with Disabilities Act. Law requiring that design accommodations be made for persons with certain disabilities.

Armor. Material used to protect slopes from erosion and scour by floodwaters, such as riprap, gabions, or concrete.

ASCE. American Society of Civil Engineers.

ATC. Applied Technology Council.

B

Bathymetry. Underwater configuration of a bottom surface of an ocean, estuary, or lake.

Berm. A mound of soil or other earthen material.

Bore. A long, broken wave propagating into a quiescent body of water, with an abrupt increase in water depth at its front face covered with turbulent, tumbling water.

Breakaway wall. A wall that is not part of the structural support of the building and is intended, through its design and construction, to collapse under specific lateral loading without causing damage to the building or supporting foundation system and allow substantially free passage of flood waters (see also tsunami breakaway wall).

Building codes. Regulations adopted by local governments that establish standards for construction, modification, and repair of buildings and other structures.

Building official. An officer or other designated authority charged with the administration and enforcement of the code, or a duly authorized representative such as a building, zoning, planning, or floodplain management official.

Bulkhead. A wall or other structure, often of wood, steel, stone, or concrete, designed to retain or prevent sliding or erosion, and occasionally used to protect against wave action.

C

CAEE. Canadian Association for Earthquake Engineering.

Cast-in-place concrete. Concrete that is formed, placed, and cured in its final location in the structure.

Cladding. Exterior surface of the building envelope.

Closure ratio. Ratio of the area of enclosure, not including glazing and openings, that is inundated to the total projected vertical plane area of the inundated enclosure surface exposed to flow pressure.

Coastal barrier. Depositional geologic features such as a bay barrier, tombolo, barrier spit, or barrier island that consists of unconsolidated sedimentary materials; is subject to wave, tidal, and wind energies; and protects landward aquatic habitats from direct wave attack.

Collapsing breaker. A type of breaking wave associated with a steep beach slope and flat incident wave, which occurs right at the instantaneous shoreline.

CDBG. Community Development Block Grant.

CERT. Community Emergency Response Team.

D

Dead load. Weight of all materials of construction incorporated into the building, including but not limited to walls, floors, roofs, ceilings, stairways, built-in partitions, finishes, cladding, and other similarly incorporated architectural and structural items and fixed service equipment. See Loads.

Debris. Solid objects or masses carried by or floating on the surface of moving water.

Debris impact loads. Loads imposed on a structure by the impact of waterborne debris.

Debris line. Markings on a structure or the ground caused by the deposition of debris, indicating the height or inland extent of floodwaters.

DHHS. Department of Health and Human Services.

DOGAMI. Department of Geology and Mineral Industries.

Design tsunami parameters. The tsunami parameters used for design, consisting of the inundation depths and flow velocities at the stages of inflow and outflow most critical to the structure and momentum flux.

Design Earthquake (DE). The earthquake hazard level that structures are specifically proportioned to resist, taken as two-thirds of the Risk-Targeted Maximum Considered Earthquake (MCE_R) hazard level.

DoD. Department of Defense.

Draft. The depth of water that a body needs in order to float.

Ductility-Governed Action. An action on a structural component resulting from short-term, dynamic loading, and characterized by a post-elastic force-deformation curve with sufficient ductility.

F

Far-source-generated tsunami. Tsunami resulting from a source located far from the site of interest, taking three hours or longer after the triggering event to arrive.

FEMA. Federal Emergency Management Agency.

FEMA MAT Report. FEMA Mitigation Assessment Team Report.

Fill. Material such as soil, gravel, or crushed stone placed in an area to increase ground elevations or change soil properties. See Structural Fill.

FIRM. Flood Insurance Rate Map.

Flood Insurance Rate Map. Under the National Flood Insurance Program, an official map of a community upon which the Federal Emergency Management Agency has delineated both the special hazard areas and the risk premium zones applicable to the community. (Note: The latest FIRM issued for a community is referred to as the effective FIRM for that community.)

Footing. The enlarged base of a foundation wall, pier, post, or column designed to spread the load of the structure so that it does not exceed the soil bearing capacity.

Force-Sustained Action. An action on a structural component resulting from sustained loading.

Freeboard. Separation between the level of water and level of refuge in a vertical evacuation structure.

G

Grade beam. Section of a concrete slab that is thicker than the slab and acts as a footing to provide stability, often under load-bearing or critical structural walls.

Grade plane. A horizontal reference plane representing the average elevation of finished grade around the building perimeter.

GSA. General Services Administration.

H

HMGP. Hazard Mitigation Grant Program.

Hydrodynamic loads. Loads imposed on an object, such as a building, by water flowing against and around it.

Hydrostatic loads. Loads imposed on a surface, such as a wall or floor slab, by a standing mass of water.

I

Impact loads. Loads that result from waterborne debris transported by tsunami waves striking against buildings and structures or parts thereof.

Impulsive forces. Force induced against a vertical obstruction subjected to the leading edge of a tsunami bore during runup.

Ingress. The act of entering a building.

Inundation depth. The depth of design tsunami water level, including relative sea level change, with respect to the grade plane at the structure.

Inundation elevation. The elevation of the design tsunami water surface, including relative sea level change, with respect to vertical datum in North American Vertical Datum of 1988 (NAVD 88).

Inundation limit. The maximum horizontal inland extent of flooding for the Maximum Considered Tsunami, where the inundation depth above grade becomes zero; the horizontal distance that is flooded, relative to the shoreline defined where the NAVD 88 elevation is zero.

L

Liquefaction. A phenomenon that occurs in saturated soils when the net pore pressure exceeds the gravity force holding soil particles together. Soil strength and stiffness decrease dramatically as the soil behaves similar to a fluid.

Loads. Forces or other actions that result from the weight of all building materials, occupants and their possessions, environmental effects, differential movement, and restrained dimensional changes.

M

Masonry. Built-up construction of combination of building units or materials of clay, shale, concrete, glass, gypsum, stone, or other approved units bonded together with or without mortar, grout, or other accepted methods of joining.

Maximum Considered Earthquake (MCE). The most severe earthquake previously considered in seismic design codes and standards, based on the United States Geological Survey seismic hazard maps, taken as a combination of: (1) 2,475-year mean recurrence interval probabilistic earthquake ground motion hazards; and (2) deterministic limits based on maximum shaking expected on known faults in the most seismically active regions. The Maximum Considered Earthquake has been replaced by the Risk-Targeted Maximum Considered Earthquake in the 2010 and later editions of ASCE/SEI 7.

Maximum Considered Tsunami (MCT). A design probabilistic tsunami having a 2% probability of being exceeded in a 50-year period or a 2,475-year mean recurrence interval.

Mid-source-generated tsunami. Tsunami generated by a source that is somewhat close the site of interest, but not close enough that the effects of the triggering event are felt at the site, taking between one hour and three hours after the triggering event to arrive.

Mitigation. Any action taken to reduce or permanently eliminate the long-term risk to life and property from natural hazards.

N

NCTR. National Center for Tsunami Research.

NCEI. National Centers for Environmental Information.

NEHRP. National Earthquake Hazard Reduction Program.

NSF. National Science Foundation.

NTWC. National Tsunami Warning Center.

Near-source-generated tsunami. Tsunami generated by a source located close to the site of interest, such that the effects of the triggering event can be felt at the site, taking one hour or less after the triggering event to arrive.

NEES. Network for Earthquake Engineering Simulation.

NIST. National Institute of Standards and Technology.

NOAA. National Oceanic and Atmospheric Administration.

Nonstructural wall. A wall that does not support vertical loads other than its own weight.

North American Vertical Datum (NAVD). Datum established in 1988 used as a basis for measuring flood, ground, and structural elevations.

NTHMP. National Tsunami Hazard Mitigation Program.

O

Offshore tsunami amplitude. Maximum Considered Tsunami amplitude relative to the Reference Sea Level, measured where the undisturbed water depth is 328 ft (100 m).

Open structure. A structure in which the portion within the inundation depth has no greater than 20% closure ratio, excluding tsunami breakaway walls, and does not have interior partitions or contents that are prevented from passing through the structure as unimpeded waterborne debris.

P

PMEL. Pacific Marine Environmental Laboratory.

PTWC. Pacific Tsunami Warning Center.

Pier foundation. Foundation consisting of isolated masonry or cast-in-place concrete structural elements extending into firm materials. Piers are relatively wide in comparison to their length, and derive their load-carrying capacity through skin friction, end bearing, or a combination of both.

Pile foundation. Foundation consisting of concrete, wood, or steel structural elements driven or jettted into the ground, or cast in place. Piles are relatively

slender in comparison to their length, and derive their load-carrying capacity through skin friction, end bearing, or a combination of both.

Plain concrete. Structural concrete with no reinforcement or with less reinforcement than the minimum amount specified for reinforced concrete.

Plunging breaker. A type of breaking wave when the wave front curls over, forming a tube; it usually happens on beaches where the slope is moderately steep.

Precast concrete. Concrete, usually a discrete structural member, that is formed, placed, and cured at one location, and subsequently moved and assembled into a final location in a structure.

PDM. Pre-Disaster Mitigation.

Probabilistic maps. Maps of predicted tsunami effects including for inundation zone, flood depths, and flow velocities, based on a method involving probability and uncertainty.

PTHA. probabilistic tsunami hazard analysis.

Progressive collapse. The spread of an initial local failure to eventual collapse of an entire structure.

R

Rapid drawdown. A sudden reduction in water level immediately prior to the first tsunami wave, or between tsunami waves.

Refuge. An evacuation facility that is intended to serve as a safe haven until an imminent danger has passed (e.g., a few hours).

Refuge of Last Resort. A building or other structure that, based on its existing structural characteristics, can serve as a secondary alternative refuge facility in the absence of a designated primary refuge facility (see also Tsunami Refuge of Last Resort).

Reinforced concrete. Structural concrete reinforced with steel and/or other reinforcing bars.

Retrofit. Any change made to an existing structure to reduce or eliminate potential damage to that structure from flooding, erosion, high winds, earthquakes, or other hazards.

Risk Category. A categorization of buildings and other structures for determination of flood, snow, ice, and earthquake loads based on the risk associated with unacceptable performance (see also Tsunami Risk Category).

Risk-Targeted Maximum Considered Earthquake (MCE_R). The most severe earthquake currently considered in seismic design codes and standards, based on the U.S. Geological Survey seismic hazard maps, determined for the orientation that results in the largest maximum horizontal response and adjusted for targeted risk. The concept of a Risk-Targeted Maximum Considered Earthquake is intended to produce more uniform risk of collapse by adjusting the return period of mapped ground motion parameters to produce a 1% probability of collapse in 50 years, except at sites near major active faults where the probabilistic motion is subjected to deterministic limits.

Runup or Runup elevation. Ground elevation at the maximum tsunami inundation limit, including relative sea level change, with respect to the North American Vertical Datum of 1988 (NAVD 88) reference datum.

S

Scour. Removal of soil or fill material by the flow of water, frequently used to describe localized conical erosion around pilings and other foundation supports where the obstruction of flow increases turbulence.

Sea wall. Solid barricade built at the water's edge to protect the shore and to prevent inland flooding.

SEI. Structural Engineering Institute of ASCE.

Shearwall. Load-bearing or non-load-bearing wall that transfers in-plane forces from lateral loads acting on a structure to its foundation.

Shelter. An evacuation facility that is intended to provide safe, accessible, and secure short-term housing for disaster survivors, typically including a place to sleep along with extended food and water supplies.

Structural fill. Fill compacted to a specified density to provide structural support or protection to a structure.

T

Topography. Configuration of a terrain, including its relief and the position of its natural and man-made features.

Tsunami. A naturally occurring series of ocean waves resulting from a rapid, large-scale disturbance in a body of water, caused by earthquakes, landslides, volcanic eruptions, and meteorite impacts.

Tsunami Breakaway Wall. A wall that is not part of the structural support of the building and is intended, through its design and construction, to collapse under specific lateral loading without causing damage to the building or supporting foundation system and allow substantially free passage of flood waters (see also breakaway wall).

Tsunami Design Zone. An area identified on the ASCE Tsunami Design Zone Map between the shoreline and the inundation limit, within which structures are analyzed and designed for inundation by the Maximum Considered Tsunami.

TLESC. Tsunami Loads and Effects Sub-Committee.

Tsunami Refuge of Last Resort. A structure that, based on its existing structural characteristics, can serve as a secondary alternative tsunami vertical evacuation refuge in the absence of a designated primary tsunami vertical evacuation refuge (see also Refuge of Last Resort).

Tsunami Risk Category. A categorization of buildings and other structures for determination of loads based on the risk associated with unacceptable performance, modified for tsunami design considerations (see also Risk Category).

Tsunami Vertical Evacuation Refuge Structure. A structure designated as a place of refuge in the event of a tsunami, and designed and constructed to resist tsunami load effects in accordance with ASCE/SEI 7-16 (see also Vertical Evacuation Refuge).

U

Undermining. Process whereby erosion or scour exceeds the depth of the base of a building foundation, or the level below which the bearing strength of the foundation is compromised.

Uplift. Vertical hydrostatic pressure under a building caused by the volume of displaced water below and around the building.

USGS. U.S. Geological Survey.

V

Vertical Evacuation Refuge. A building, non-building structure, or earthen mound designated as a place of refuge in the event of a tsunami, with sufficient height to elevate evacuees above the tsunami inundation depth, designed and constructed to resist tsunami load effects (see also Tsunami Vertical Evacuation Refuge Structure).

W

Waterborne debris. Any object transported by tsunami waves (e.g., driftwood, boats, shipping containers, automobiles).

References

- ACI, 2014, *Building Code Requirements for Structural Concrete* (ACI 318-14) and *Commentary* (ACI 318R-14), American Concrete Institute, Farmington Hills, Michigan.
- ARC, 2002, *Standards for Hurricane Evacuation Shelter Selection*, Publication No. 4496, American Red Cross, Tallahassee Florida, available at <http://www.drc-group.com/library/exercise/aa/AA-ARC-4496.pdf>, last accessed December 24, 2018.
- ASCE, 2010, *Minimum Design Loads for Buildings and Other Structures*, ASCE/SEI Standard 7-10, American Society of Civil Engineers, Reston, Virginia.
- ASCE, 2014a, *Flood Resistant Design and Construction*, ASCE/SEI Standard 24-14, American Society of Civil Engineers, Reston, Virginia.
- ASCE, 2014b, *Seismic Evaluation and Retrofit of Existing Buildings*, ASCE/SEI Standard 41-13, American Society of Civil Engineers, Reston, Virginia.
- ASCE, 2016, *Minimum Design Loads and Associated Criteria for Buildings and Other Structures*, ASCE/SEI Standard 7-16, American Society of Civil Engineers, Reston, Virginia.
- ASCE, 2017a, *Seismic Evaluation and Retrofit of Existing Buildings*, ASCE/SEI Standard 41-17, American Society of Civil Engineers, Reston, Virginia.
- ASCE, 2017b, “Tsunami Design Geodatabase Version 2016-1.0,” *ASCE Tsunami Hazard Tool*, American Society of Civil Engineers, Reston, Virginia, available at <https://asce7tsunami.online>, last accessed December 24, 2018.
- Ash, C., 2015, “Design of a Tsunami Vertical Evacuation Refuge Structure in Westport, Washington,” *Proceedings*, ASCE Structures Congress, Portland, Oregon, pp. 1530-1537.

- Butler, R., Burney, D., and Walsh, D., 2014, "Paleotsunami evidence on Kaua'i and numerical modeling of a great Aleutian tsunami," *Geophysical Research Letters*, Vol. 41, No. 19, pp. 6795-6802, DOI:10.1002/2014GL061232.
- CAEE, 2005, *Reconnaissance Report on the December 26, 2004 Sumatra Earthquake and Tsunami*, Canadian Association for Earthquake Engineering, Vancouver, British Columbia, Canada.
- Carden, L.P., Yu, G., Chock, G., and Robertson, I., 2016, "Tsunami-Resilient Building Designs for Hawaii and Other High Hazard Regions," *Proceedings*, Structural Engineers Association of California Convention, Kaanapali, Maui, Hawaii.
- Carrier, G.F., and Yeh, H., 2005, "Tsunami Propagation from a Finite Source," *Computer Modeling in Engineering & Sciences*, Vol. 10, pp. 113-122.
- CGS, 2006, *Historic Tsunamis in California*, California Geologic Survey, California Department of Conservation, Sacramento, California, <https://www.conservation.ca.gov/cgs/geohazards/tsunami>, last accessed December 24, 2018.
- Chock, G., 2016, "Design for Tsunami Loads and Effects in the ASCE 7-16 Standard," *Journal of Structural Engineering*, 142(11):04016093.
- Chock, G., Carden, L., Robertson, I., Wei, Y., Wilson, R., and Hooper, J., 2018, "Tsunami Resilient Building Design Considerations for Coastal Communities of Washington, Oregon and California," *Journal of Structural Engineering*, 144(8):04018116.
- Chock, G., Carden, L., Robertson, I., Olsen, M. J., and Yu, G., 2013a, "Tohoku tsunami-induced building failure analysis with implications for USA tsunami and seismic design codes," *Earthquake Spectra*, 29(S1), S99–S126.
- Chock, G., Robertson, I., Kriebel, D., Francis, M., and Nistor, I., 2013b, *Tohoku, Japan, Earthquake and Tsunami of 2011: Performance of Structures Under Tsunami Loads*, American Society of Civil Engineers, Reston, Virginia.
- Chock, G., Yu, G., Thio, H.K., Lynett, P., 2016, "Target Structural Reliability Analysis for Tsunami Hydrodynamic Loads of the ASCE 7 Standard," *Journal of Structural Engineering* 142(11):04016092.

- City and County of Honolulu, 2007, *City and County of Honolulu Building Code*, Department of Planning and Permitting, City and County of Honolulu, Hawaii.
- City and County of Honolulu, 2018, “Tsunami Evacuation Zones,” *City and County of Honolulu*, http://www.honolulu.gov/rep/site/dem/dem_docs/tsunami_evac/etez_final/Waikiki_map_1_waikiki.pdf, last accessed on December 24, 2018.
- City of New York, 2013, *PlaNYC – A Stronger, More Resilient New York*, Mayor Michael R. Bloomberg’s Office, New York, New York, available at <https://www1.nyc.gov/site/sirr/report/report.page>, last accessed on December 24, 2018.
- Conner, D., 2005, *The City of Seaside’s Tsunami Awareness Program. Outreach assessment: How to implement an effective tsunami preparedness outreach program*, Open-File Report 0-05-10, State of Oregon Department of Geology and Mineral Industries, Newport, Oregon.
- Dalrymple, R.A., and Kriebel, D.L., 2005, “Lessons in Engineering from the Tsunami in Thailand,” *The Bridge*, pp. 4-13.
- Dames & Moore, 1980, *Design and Construction Standards for Residential Construction in Tsunami-Prone Areas in Hawaii*, prepared by Dames & Moore for the Federal Emergency Management Agency, Washington, D.C.
- DGPP, 1995, *Guidelines for Tsunami Evacuation Buildings*, Director-General for Policy Planning, Government of Japan (in Japanese).
- DHHS, 2014, *Hospital Preparedness and Response During Hurricane Sandy*, Office of the Inspector General, Report No. OEI-06-13-00260, U.S. Department of Health and Human Services, Washington, D.C.
- DOD, 2016, *Design of Buildings to Resist Progressive Collapse*, Unified Facilities Criteria (UFC) 4-023-03, Department of Defense, Washington, D.C.
- DOGAMI, 2018, “Evacuation Brochures,” *Oregon Tsunami Clearinghouse/Resource Library*, State of Oregon Department of Geology and Mineral Industries, Newport, Oregon, <https://www.oregongeology.org/tsuclearinghouse/pubs-evacbro.htm>, last accessed December 24, 2018.

- Dunbar, P., and Weaver, C.S., 2015, *United States and Territories National Tsunami Hazard Assessment: Historical Record and Sources for Waves – Update*, prepared for the National Tsunami Hazard Mitigation Program, published jointly by the National Oceanic and Atmospheric Administration and the U.S. Geological Survey, available at https://nws.weather.gov/nthmp/documents/Tsunami_Assessment_2016Update.pdf, last accessed December 24, 2018.
- FEMA, 2006a, *Hurricane Katrina in the Gulf Coast—Summary Report, Mitigation Assessment Team Report*, FEMA 548, Federal Emergency Management Agency, Washington, D.C.
- FEMA, 2006b, *Hurricane Katrina in the Gulf Coast—Observations, Recommendations, and Technical Guidance, Mitigation Assessment Team Report*, FEMA 549, Federal Emergency Management Agency, Washington, D.C.
- FEMA, 2008, *Guidelines for Design of Structures for Vertical Evacuation from Tsunamis*, FEMA P-646 (First Edition), prepared by the Applied Technology Council for the Federal Emergency Management Agency, Washington, D.C.
- FEMA, 2009, *Vertical Evacuation from Tsunamis: A Guide for Community Officials*, FEMA P-646A, prepared by the Applied Technology Council for the Federal Emergency Management Agency, Washington, D.C.
- FEMA, 2011, *Coastal Construction Manual, Principles and Practices of Planning, Siting, Designing, Constructing, and Maintaining Residential Buildings in Coastal Areas (Fourth Edition)*, FEMA P-55, Volume I and Volume II, Federal Emergency Management Agency, Washington, D.C.
- FEMA, 2012a, *Guidelines for Design of Structures for Vertical Evacuation from Tsunamis*, FEMA P-646, Second Edition, prepared by the Applied Technology Council for the Federal Emergency Management Agency, Washington, D.C.
- FEMA, 2012b, *Reducing the Risks of Nonstructural Earthquake Damage*, FEMA E-74, prepared by the Applied Technology Council for the Federal Emergency Management Agency, Washington, D.C.
- FEMA, 2014a, *Emergency Power Systems for Critical Facilities: A Best Practices Approach to Improving Reliability*, FEMA P-1019, prepared by the Applied Technology Council for the Federal Emergency Management Agency, Washington, D.C.

- FEMA, 2014b, *Hazus-MH 3.0: Multi-hazard Loss Estimation Methodology*, Federal Emergency Management Agency, Washington, D.C.
- FEMA, 2015b, *Safe Rooms for Tornadoes and Hurricanes: Guidance for Community and Residential Safe Rooms*, FEMA P-361, Third Edition, Federal Emergency Management Agency, Washington, D.C.
- FEMA, 2018, *Seismic Performance Assessment of Buildings, Methodology and Implementation*, FEMA P-58 series, prepared by the Applied Technology Council for the Federal Emergency Management Agency, Washington, D.C.
- Fukuyama, H., and Okoshi, T., 2005, *Introduction of the Tsunami Resisting Design Method for Buildings Proposed by the Building Center of Japan*, Building Center of Japan, Tokyo, Japan.
- Fraser, S., Leonard, G.S., Matsuo, I., and Murakami, H., 2012, *Tsunami evacuation: Lessons from the Great East Japan earthquake and tsunami of March 11th 2011*, GNS Science Report 2012/17.
- Ge, M., and Robertson, I.N., 2010, *Uplift loading on elevated floor slab due to a tsunami bore*, Research Report UHM/CEE/10-03, University of Hawaii, Manoa.
- Geist, E. L., 1999, "Local Tsunamis and Earthquake Source Parameters," *Advances in Geophysics*, Vol. 39, pp. 117-209.
- González, F.I., Titov, V.V., Mofjeld, H.O., Venturato, A., Simmons, S., Hansen, R., Combellick, R., Eisner, R., Hoirup, D., Yanagi, B., Yong, S., Darienzo, M., Priest, G., Crawford, G., and Walsh, T., 2005, "Progress in NTHMP Hazard Assessment," *Natural Hazards*, Special Issue: U.S. National Tsunami Hazard Mitigation Program, Vol. 35, No. 1, pp. 89-110.
- GSA, 2013, *Alternate Path Analysis and Design Guidelines for Progressive Collapse Resistance*, General Services Administration, Washington, D.C.
- Haehnel, R.B., and Daly, S.F., 2002, *Maximum Impact Force of Woody Debris on Floodplain Structures*, Technical Report ERDC/CRREL TR-02-2, U.S. Army Corps of Engineers, Springfield, Virginia.
- ICC, 2015, *International Building Code*, International Code Council, Inc., Country Club Hills, Illinois.
- ICC, 2018, *International Building Code*, International Code Council, Inc., Country Club Hills, Illinois.

- ICC/NSSA, 2014, *Standard for the Design and Construction of Storm Shelters*, ICC 500-2014, International Code Council and National Storm Shelter Association, Country Club Hills, Illinois.
- Kisei, 2008, Kisei Town Hall Prevention of Disasters Section, *Tower of Relief - Life is Protected from Tidal Wave Disaster*, <http://www.webmie.or.jp/~kisei-t/bosai.html>, (translated from Japanese), last accessed June 12, 2008.
- Kleinman, R.D., Johnson, G.P., and Robertson, I.N., 2007, *Development of Breakaway Walls for Tsunami Loading*, UHM/CEE/07-04, University of Hawaii Research Report.
- Knill, J., and Knill, J., 2004, Cable News Network, <http://www.cnn.com/SPECIALS/2004/tsunami.disaster/>, last accessed June 12, 2008.
- Ko, H.T-S., Cox, D.T., Riggs, H.R., and Naito, C.J., 2014, “Hydraulic Experiments on Impact Forces from Tsunami-Driven Debris,” *Journal of Waterway Port Coastal and Ocean Engineering*, Vol. 141, No. 3.
- Kowalik, Z., and Murty, T. S., 1993a, *Numerical Modeling of Ocean Dynamics*, World Scientific Publishing Co. Pte., Ltd., Singapore.
- Kowalik, Z., and Murty, T. S., 1993b, “Numerical Simulation of Two-Dimensional Tsunami Runup,” *Marine Geodesy*, Vol. 16, pp. 87-100.
- Lander, J.F., 1999, *Caribbean Tsunamis: An Initial History*, available at http://www.mona.uwi.edu/uds/Tsunami_Lander.html, last accessed December 24, 2018.
- Liu, P.L.-F., Synolakis, C.E., and Yeh, H., 2006, *Report on the Tsunami Model Benchmark Comparisons Workshop*, National Science Foundation Report, Catalina Island, California.
- Lockridge, P.A., Whiteside, L.S., Lander, J.F., 2002, “Tsunamis and Tsunami-Like Waves of the Eastern United States,” *Science of Tsunami Hazards*, Vol. 20, No. 3.
- Luettich, R.A., Westerink, J.J., and Scheffner, N.W., 1991, *An Advanced Three-Dimensional Circulation Model for Shelves, Coasts, and Estuaries*, U.S. Army Corps of Engineers, Washington, D.C.
- Luettich, R.A., and Westerink, J.J., 1995a, *An Assessment of Flooding and Drying Techniques for Use in the ADCIRC Hydrodynamic Model: Implementation and Performance in One-Dimensional Flows*, U.S. Army Corps of Engineers, Vicksburg, Mississippi.

- Luettich, R.A., and Westerink, J.J., 1995b, *Implementation and Testing of Elemental Flooding and Drying in the ADCIRC Hydrodynamic Model*, U.S. Army Corps of Engineers, Vicksburg, Mississippi.
- Mas, E., Suppasri, A., Imamura, F., and Koshimura, S., 2012, “Agent-based simulation of the 2011 Great East Japan earthquake/tsunami evacuation: an integrated model of tsunami inundation and evacuation,” *Journal of Natural Disaster Science*, Vol. 34, No. 1, pp. 41-57.
- Murakami, H., Fraser, S., Leonard, G.S., and Matsuo, I., 2012, “A Field Study on Conditions and Roles of Tsunami Evacuation Buildings in the 2011 Tohoku Pacific Earthquake and Tsunami,” *Proceedings of the 9th International Conference of Urban Earthquake Engineering*, Tokyo, Japan, pp. 89-95.
- Myers, E.P., and Baptista, A.M., 1995, “Finite Element Modeling of the July 12, 1993 Hokkaido Nansei-Oki Tsunami,” *Pure and Applied Geophysics*, Vol. 144, No. 3/4, pp. 769-801.
- Naito, C., Cercone, C., Riggs, H.R., and Cox, D., 2014, “Procedure for site assessment of the potential for tsunami debris impact,” *J. Waterway, Port, Coastal, Ocean Eng.*, 10.1061/(ASCE)WW.1943-5460.0000222, 223–232.
- NIST, 2007, *Engineering Design and Cost Data for Reinforced Concrete Buildings for Next Generation Design and Economic Standards for Structural Integrity*, prepared by S.K. Ghosh Associates, Inc., in collaboration with Baldrige & Associates Structural Engineering, Inc., for the National Institute of Standards and Technology, Gaithersburg, Maryland.
- NIST, 2016, *Critical Assessment of Lifeline Systems Performance: Understanding Societal Needs in Disaster Recovery*, NIST GCR 16-917-39, prepared by Applied Technology Council for the National Institute of Standards and Technology, Gaithersburg, Maryland.
- Nitta, P., and Robertson, I., 2014, “Cost Implications of Including Tsunami Design in Prototypical Coastal Buildings,” *Research Report UHM/CEE/14-03*, University of Hawaii, Honolulu, Hawaii.
- NOAA/NCEI, 2018, *NCEI/WDS Global Historical Tsunami Database, 2100 BC to Present*, National Oceanic and Atmospheric Administration (NOAA), National Centers for Environmental Information (NCEI), World Data Service (WDS), DOI:10.7289/V5PN93H7.

- NOAA/NGDC, 2008, National Oceanic and Atmospheric Administration (NOAA), National Geophysical Data Center (NGDC), http://www.ngdc.noaa.gov/nndc/struts/results?eq_1=25&t=101634&s=0&d=4&d=44, last accessed June 12, 2008.
- NTHMP, 2012, *Proceedings and Results of the 2011 NTHMP Model Benchmarking Workshop*, National Tsunami Hazard Mitigation Program, National Oceanic and Atmospheric Administration (NOAA) Special Report, <https://permanent.access.gpo.gov/gpo44987/nthmpWorkshopProcMerged.pdf>, last accessed December 24, 2018.
- Okada, T., Sugano, T., Ishikawa, T., Ohgi, T., Takai, S., and Hamabe, C., 2005, *Structural Design Method of Buildings for Tsunami Resistance (SDBTR)*, The Building Center of Japan, Building Technology Research Institute, Tokyo, Japan.
- Okal, E.A., 2003, "Normal Mode Energetics for Far-Field Tsunami Generated by Dislocations and Landslides," *Pure Applied Geophysics*, Vol. 160, pp. 2189-2221.
- Pararas-Carayannis, G., 1968, "Catalog of Tsunamis in Hawaiian Islands," *The Tsunami Page*, <http://www.drgeorgepc.com/TsunamiCatalogHawaii.html>, last accessed December 24, 2018.
- Pararas-Carayannis, G., 1976, "The November 29, 1975 Tsunami in the Hawaiian Islands," *The Tsunami Page*, <http://www.drgeorgepc.com/Tsunami1975.html>, last accessed December 24, 2018.
- Park, S., van de Lindt, J., Gupta, R., and Cox, D., 2012, "Method to determine the locations of tsunami vertical evacuation shelters," *Natural Hazards*, Vol. 63, pp. 891-908.
- Piran Aghl, P., Naito, C.J., and Riggs, H.R., 2014, "Full-Scale Experimental Study of Impact Demands Resulting from High Mass, Low Velocity Debris," *Journal of Structural Engineering*, Vol. 140, No. 5.
- Piran Aghl, P., Naito, C.J., and Riggs, H.R., 2015, "Effect of nonstructural mass on debris impact demands: Experimental and simulation studies," *Engineering Structures*, Vol. 88.
- Priest, G.R., Goldfinger, C., Wang, K., Witter, R.C., Zhang, Y., and Baptista, A.M., 2008, "Tsunami Hazard Assessment of the Northern Oregon Coast: A Multi-deterministic Approach Tested at Cannon Beach, Oregon," *Special Paper 41*, Oregon Department of Geology and Mineral Industries.

- Ramsden, J.D., 1993, *Tsunamis: Forces on a Vertical Wall Caused by Long Waves, Bores, and Surges on a Dry Bed*, Report No. KH-R-54, W.M. Keck Laboratory, California Institute of Technology, Pasadena, California.
- Riggs, H.R., Cox, D.T., Naito, C.J., Kobayashi, M.H., Piran Aghl, P., Ko, H.T.-S., Khowitar, E., 2014, “Experimental and Analytical Study of Water-Driven Debris Impact Forces on Structures,” *Journal of Offshore Mechanics and Arctic Engineering*, Vol. 136.
- Robertson, I.N., 2018, “Tsunami Loads and Effects: Guide to the Tsunami Design Provisions of ASCE 7-16,” American Society of Civil Engineers, Reston, Virginia.
- Robertson, I.N., Paczkowski, K., Riggs, H.R., and Mohamed, A., 2013, “Experimental investigation of tsunami bore forces on vertical walls,” *Journal of Offshore Mechanics and Arctic Engineering*, Vol. 135 No. 2.
- Satake, K., Wang, K., and Atwater, B.F., 2003, “Fault Slip and Seismic Moment of the 1700 Cascadia Earthquake Inferred from Japanese Tsunami Descriptions,” *Journal of Geophysical Research*, Vol. 108.
- Shuto, N., 1991, “Numerical Simulation of Tsunamis,” *Tsunami Hazard*, Kluwer Academic Publishers, Dordrecht, Netherlands, pp. 171-191.
- Suleimani, E.N., Combellick, R.A., Hansen, R.A., and Carver, G.A., 2002a, “Tsunami Hazard Mapping of Alaska Coastal Communities,” *TsunInfo Alert*, Vol. 4, No. 4, pp. 4-8.
- Suleimani, E.N., Hansen, R.A., Combellick, R.A., Carver, G.A., Kamphaus, R.A., Newman, J.C., and Venturato, A.J., 2002b, “Tsunami Hazard Maps of the Kodiak Area, Alaska,” Report of Investigations 2002-1, State of Alaska Department of Natural Resources, Division of Geological & Geophysical Surveys.
- Synolakis, C.E., Bernard, E.N., Titov, V.V., Kanoglu, U., González, F.I., 2007, *Standards, Criteria and Procedures for NOAA Evaluation of Tsunami Numerical Models*, NOAA Technical Memorandum OAR PMEL-135, Pacific Marine Environmental Laboratory, Seattle, Washington.
- Thio, H.K., and Wei, Y., 2017, “Development of offshore probabilistic tsunami exceedance amplitudes for ASCE 7-16,” *Proceedings*, 16th World Conference on Earthquake Engineering (16WCEE), Santiago, Chile.

- Titov, V.V., 1997, *Numerical Modeling of Long Wave Runup*, Ph.D. Thesis, University of Southern California, Los Angeles, California.
- Titov, V., and González, F.I., 1997, *Implementation and Testing of the Method of Splitting Tsunami (MOST) Model*, NOAA Technical Memo ERL PMEL-112 (PB98-122773), NOAA/Pacific Marine Environmental Laboratory, Seattle, Washington.
- Titov, V.V., González, F.I., Bernard, E.N., Eble, M.C., Mofjeld, H.O., Newman, J.C., and Venturato, A.J., 2005, “Real-time Tsunami Forecasting: Challenges and Solutions,” *Natural Hazards*, Special Issue, U.S. National Tsunami Hazard Mitigation Program, Vol. 35, No. 1, pp. 41-58.
- UNESCO/IOC, 2016, *Tsunami Glossary, Third Edition*, UNESCO/IOC Technical Series, 85, United Nations Educational, Scientific and Cultural Organization (UNESCO), Intergovernmental Oceanographic Commission (IOC), Paris, France, available at http://itic.ioc-unesco.org/index.php?option=com_content&view=article&id=1328&Itemid=2434, last accessed December 24, 2018.
- USACE, 2011, *Coastal Engineering Manual*, EM 1110-2-1100, U.S. Army Corps of Engineers, Washington, D.C.
- Wang, H., Mostafizi, A., Cramer, L.A., Cox, D., and Park, H., 2015, “An agent-based model of a multimodal near-field tsunami evacuation: Decision-making and life safety,” *Transportation Research Part C, Emerging Technologies*, Vol. 64, pp. 86-100.
- Washington Emergency Management Division, 2018, “Listing of Disaster Recovery Funding Resources,” *Pre and Post-Disaster Recovery for Community Organizations and Local Government*, Washington Emergency Management Division, available at <https://mil.wa.gov/uploads/pdf/emergency-management/feddisasterrecoveryfundinglinks.pdf>, last accessed on December 24, 2018.
- Wei, Y., and Thio, H.K., 2017, “Tsunami Inundation Modeling to Create 2,500-year Return Period Tsunami Design Zone Maps for the ASCE 7-16 Standards,” *Proceedings*, 16th World Conference on Earthquake Engineering (16WCEE), Santiago, Chile.
- Wiegel, R.L., 1964, *Oceanographical Engineering*, Prentice-Hall, Inc., Englewood Cliffs, New Jersey.
- Wiegel, R.L., 2005, *Tsunami Information Sources, Hydraulic Engineering Laboratory Technical Report*, UCB/HEL 2005-1, University of California, Berkeley, California.

- Wiegel, R.L., 2006a, *Tsunami Information Sources, Part 2, Hydraulic Engineering Laboratory Technical Report*, UCB/HEL 2006-1, University of California, Berkeley, California.
- Wiegel, R.L., 2006b, *Tsunami Information Sources, Part 3, Hydraulic Engineering Laboratory Technical Report*, UCB/HEL 2006-3, University of California, Berkeley, California.
- Wiegel, R.L., 2008, *Tsunami Information Sources, Part 4, Hydraulic Engineering Laboratory Technical Report*, UCB/HEL 2008-1, University of California, Berkeley, California.
- Wood, N., Jones, J., Schelling, J., and Schmidlein, M., 2014, "Tsunami vertical-evacuation planning in the U.S. Pacific Northwest as a geospatial, multi-criteria decision problem," *International Journal of Disaster Risk Reduction*, Vol. 9, pp 68-83.
- Wood, N., Jones, J., Schmidlein, M., Schelling, J., and Frazier, T., 2016, "Pedestrian flow-path modeling to support tsunami evacuation and disaster relief planning in the U.S. Pacific Northwest," *International Journal of Disaster Risk Reduction*, Vol. 18, pp. 41-55.
- Yamazaki, Y., Cheung, K.F., and Kowalik, Z., 2011, "Depth-integrated, non-hydrostatic model with grid nesting for tsunami generation, propagation, and run-up," *Int. Journal for Numerical Methods in Fluids*, Vol. 67, No. 12, pp. 2081-2107.
- Yeh, H., Liu, P.L.-F., and Synolakis, C.E., 1996, *Long-wave Runup Models, Friday Harbor, USA*, World Scientific Publishing Co. Pte., Ltd., Singapore, pp. 12-17.
- Yeh, H., Robertson, I., and Preuss, J., 2005, *Development of Design Guidelines for Structures that Serve as Tsunami Vertical Evacuation Sites*, Open File Report 2005-4, Washington Division of Geology and Earth Resources, State of Washington (contract 52-AB-NR-200051), Olympia, Washington.

Project Participants

Federal Emergency Management Agency

Michael Mahoney (Project Officer)
Federal Emergency Management Agency
400 C Street, SW
Washington, D.C. 20472

Robert D. Hanson
(FEMA Technical Monitor – First Edition)
5885 Dunabbey Loop
Dublin, Ohio 3017

Applied Technology Council

Jon A. Heintz
(Project Executive/Project Manager –
First and Third Editions)
Applied Technology Council
201 Redwood Shores Parkway, Suite 240
Redwood City, California 94065

Ayse Hortacsu
(Project Manager – FEMA P-646A)
Applied Technology Council
201 Redwood Shores Parkway, Suite 240
Redwood City, California 94065

Christopher Rojahn
(Project Executive – First Edition)
Applied Technology Council
201 Redwood Shores Parkway, Suite 240
Redwood City, California 94065

William T. Holmes
(ATC Technical Monitor – First Edition)
Rutherford + Chekene
375 Beale Street, Suite 310
San Francisco, California 94105

William L. Coulbourne
(Project Manager – Second Edition)
Applied Technology Council
201 Redwood Shores Parkway, Suite 240
Redwood City, California 94065

Subject Matter Expert/Lead Author (Third Edition)

Ian N. Robertson
University of Hawaii at Manoa
Dept. of Civil and Environmental Engineering
2540 Dole Street, Holmes Hall 383
Honolulu, Hawaii 96822

Project Review Panel (Third Edition)

Tamra Biasco
FEMA, Region X
130 - 228th Street, Southwest
Bothell, Washington 98021

Gary Chock
Martin and Chock
1132 Bishop Street, Suite 1550
Honolulu, Hawaii 96813

Maximillian Dixon
Washington Military Department
Emergency Management Division
20 Aviation Drive
Camp Murray, Washington 98430

Laura Kong
National Oceanic and Atmospheric Administration
International Tsunami Information Center
1845 Wasp Boulevard, Building 176
Honolulu, Hawaii 96818

John Hooper
Magnusson Klemencic Associates
1301 Fifth Avenue, Suite 3200
Seattle, Washington 98101

Kevin Miller
California Office of Emergency Services
30 Van Ness Avenue, Suite 3300
San Francisco, California 94102

Michael Hornick
FEMA, Region IX
1111 Broadway, Suite 1200
Oakland, California 94607

Amanda Siok
FEMA, Region X
130 - 228th Street, Southwest
Bothell, Washington 98021

Project Management Committee (Second Edition)

Ian N. Robertson (Project Technical Director)
University of Hawaii at Manoa
Dept. of Civil and Environmental Engineering
2540 Dole Street, Holmes Hall 383
Honolulu, Hawaii 96822

Timothy J. Walsh
Dept. of Nat. Resources, Geo. & Earth Resources
1111 Washington Street SE, P.O. Box 47007
Olympia, Washington 98504

Gary Chock
Martin and Chock
1132 Bishop Street, Suite 1550
Honolulu, Hawaii 96813

Harry Yeh
Oregon State University
School of Civil & Construction Engineering
220 Owen Hall
Corvallis, Oregon 97331

John Hooper
Magnusson Klemencic Associates
1301 Fifth Avenue, Suite 3200
Seattle, Washington 98101

Project Management Committee (First Edition)

Steven Baldrige (Project Technical Director)
BASE Research & Development, LLC
1164 Bishop Street, Suite 605
Honolulu, Hawaii 96813

Ian N. Robertson
University of Hawaii at Manoa
Dept. of Civil and Environmental Engineering
2540 Dole Street, Holmes Hall 383
Honolulu, Hawaii 96822

Frank Gonzalez
National Oceanic and Atmospheric Administration
Pacific Marine Environmental Laboratory
7600 Sand Point Way NE, Building 3
Seattle, Washington 98115

Timothy J. Walsh
Dept. of Nat. Resources, Geo. & Earth Resources
1111 Washington Street SE, P.O. Box 47007
Olympia, Washington 98504

John Hooper
Magnusson Klemencic Associates
1301 Fifth Avenue, Suite 3200
Seattle, Washington 98101

Harry Yeh
Oregon State University
School of Civil & Construction Engineering
220 Owen Hall
Corvallis, Oregon 97331

Project Review Panel (First Edition)

Christopher P. Jones (Chair)
5525 Jomali Drive
Durham, North Carolina 27705

John Aho
CH2M Hill
301 West Northern Lights Boulevard, Suite 601
Anchorage, Alaska 99503

George Crawford
Washington State Military Dept.
Emergency Management Division
Camp Murray, Washington 98430

Richard Eisner
Governor's Office of Emergency Services
1300 Clay Street, Suite 400
Oakland, California 94612

Lesley Ewing
California Coastal Commission
45 Fremont Street, Suite 2000
San Francisco, California 94105

Michael Hornick
FEMA, Region IX
1111 Broadway, Suite 1200
Oakland, California 94607

Chris Jonientz-Trisler
FEMA, Region X
130 228th Street SW
Bothell, Washington 98021

Marc L. Levitan
LSU Hurricane Center
Suite 3221 CEBA Building
Louisiana State University
Baton Rouge, Louisiana 70803

George R. Priest
Oregon Dept. of Geology and Mineral Industries
Newport Coastal Field Office
P.O. Box 1033
Newport, Oregon 97365

Charles W. Roeder
University of Washington
Dept. of Civil and Environmental Engineering
233-B More Hall, Box 2700
Seattle, Washington 98195

Jay Wilson
Clackamas County Department of Emergency
Management
2200 Kaen Road
Oregon City, Oregon 97045

Report Preparation Consultants (FEMA P-646A)

J.L. Clark
16792 SE Knoll Court
Milwaukie, Oregon 97267

George Crawford
SeismicReady
3624 Arbor Drive SE
Lacey, Washington 98503

Project Review Panel (FEMA P-646A)

Lesley Ewing
California Coastal Commission
45 Fremont Street, Suite 2000
San Francisco, California 94105

William T. Holmes
Rutherford + Chekene
375 Beale Street, Suite 310
San Francisco, California 94105

James D. Goltz
California Office of Emergency Services
California Institute of Technology
1200 East California Blvd., MC 104-44
Pasadena, California 91125

Ervin Petty
Alaska Division of Homeland Security &
Emergency Management
Suite B-210, Bldg. 49000
Fort Richardson, Alaska 99505

George Priest
Oregon Dept. of Geology & Mineral Industries
Newport Coastal Field Office
P.O. Box 1033
Newport, Oregon 97365

Timothy J. Walsh
Dept. of Natural Resources, Geology & Earth
Resources
1111 Washington Street SE, P.O. Box 47007
Olympia, Washington 98504

Althea Turner
Oregon Emergency Management
3225 State Street
Salem, Oregon 97301



FEMA

FEMA P-646
Third Edition